

OPERATION MANUAL

STB8851

Precision Impedance Analyzer

Saluki Technology Inc.

www.salukitec.com

Contents

Chapter 1	Out of Box Audit.....	1
1.1	To Inspect the package.....	1
1.2	Power connection.....	1
1.3	Fuse.....	1
1.4	Environment.....	1
1.5	Use of Test Fixture.....	2
1.6	Warm-up.....	2
1.7	Other features.....	2
1.8	Safe Usage.....	2
Chapter 2	Introduction.....	4
2.1	Introduction to front panel.....	4
2.2	Introduction to rear panel.....	8
2.3	Screen Area.....	9
2.3.1	Screen interface display.....	9
2.3.2	Point measurement display interface.....	10
2.3.3	List measurement display interface.....	12
2.3.4	Sweep measurement display interface.....	12
2.3.5	User Calibration Interface.....	15
2.3.6	Accessory Calibration Interface.....	16
2.3.7	Point measurement and comparatpor setting interface.....	16
2.3.8	List setting interface.....	18
2.3.9	List quick edit interface.....	18
2.3.10	List comparator setting interface.....	19
2.3.11	Sweep comparator setting interface.....	19
2.3.12	Sweep segment setting interface.....	20
2.4	Measurement examples.....	21
2.4.1	Equipment requirements.....	22
2.4.2	Measurement preparation.....	22
2.4.3	User measurement calibration.....	23
2.4.4	Point measurement example.....	24
2.4.5	List measurement example.....	25
2.4.6	Sweep measurement example.....	27
Chapter 3	User Calibration.....	31
3.1	Overview.....	31
3.2	All frequency user calibration setup.....	31
3.2.1	Choose a measuring accessory.....	31
3.2.2	User open calibration.....	32
3.2.3	User short calibration.....	33
3.2.4	User load calibration.....	34
3.2.5	Phase calibration.....	35
3.2.6	Accessory Calibration.....	36
3.3	User calibration point settings.....	37

3.3.1	Toggle calibration point switch state.....	37
3.3.2	Set the frequency of the calibration point	37
3.3.3	Set the load reference for the calibration point	37
3.3.4	Open clear of calibration point.....	37
3.3.5	Short clear of calibration point.....	38
3.3.6	Load calibration at calibration point	38
Chapter 4	Point Measurement.....	39
4.1	Channel	39
4.2	Frequency.....	39
4.3	Meas Time.....	40
4.4	Avg Count	41
4.5	OSC Level.....	41
4.6	DC Bias	42
4.7	AC Range.....	43
4.8	Trigger.....	44
4.8.1	Trigger Mode.....	44
4.8.2	Trigger Delay	45
4.9	Result	45
4.9.1	Parameter	45
4.9.2	Math Mode.....	47
4.9.3	Reference	48
4.10	Comparator.....	49
4.10.1	Condition1~4.....	50
4.10.2	BIN.....	51
Chapter 5	List Measurement.....	55
5.1	Channel	55
5.2	Measurement Point.....	55
5.2.1	Add Row	56
5.2.2	Copy, Paste and Delete Row	57
5.2.3	Measurement Settings	58
5.3	Trigger.....	62
5.3.1	Trigger Mode.....	62
5.3.2	List Type.....	62
5.3.3	Point Delay.....	63
5.4	Result	63
5.4.1	Parameter	63
5.4.2	Comparator.....	64
Chapter 6	Trace Sweep Measurement	66
6.1	Setting Measurement Conditions	66
6.1.1	Initialization	66
6.1.2	Setting Channels and Traces	66
6.1.3	Sweep Parameters Settings.....	70
6.1.4	Setting Signal Source	76
6.1.5	Setting Trigger.....	78

6.1.6	Measurement of Multiple Sweep Ranges with Different Conditions in a Single Action (Segment Sweep).....	79
6.2	Setting Display Format of Measurement Result	80
6.2.1	Selecting Measurement Parameters.....	81
6.2.2	Setting Format of Y-Axis	82
6.2.3	Scaling Trace.....	83
6.2.4	Comparison and Calculation of Trace	84
6.2.5	Monitoring Source Signal Level	85
6.2.6	Setting Form Display	86
6.3	Analysis and Processing of Measurement Data	87
6.3.1	Analyzing Data by Marker	87
6.3.2	Searching Specific Measurement Point on a Trace	89
6.3.3	Analyzing Equivalent Circuit and Simulate Frequency Characteristics	93
6.3.4	Crystal Oscillator Analysis.....	95
6.3.5	Trace Statistical Data.....	96
6.3.6	Trace Limit Line.....	98
6.3.7	Trace Trails Comparison	100
Chapter 7	Save and Recall	102
7.1	Point Measurement.....	102
7.1.1	Save	102
7.1.2	Recall	103
7.1.3	Screen Capture	103
7.2	List Measurement.....	104
7.3	Comparator.....	105
7.3.1	Save	105
7.3.2	Load	106
7.4	Sweep.....	106
7.4.1	State.....	106
7.4.2	Channel	107
7.4.3	Trace Data	108
Chapter 8	System Setup.....	109
8.1	System Calibration	109
8.2	Language Settings.....	109
8.3	System Test	109
8.3.1	Front Panel Test.....	110
8.3.2	Handler Test	110
8.4	Preset.....	111
8.5	System Information and Software Updates.....	111
8.6	Misc Setup.....	112
8.6.1	GPIB Setup	112
8.6.2	Network Setup.....	112
8.6.3	Serial Port Setup.....	112
8.6.4	Preset Setup.....	112
8.6.5	Startup Setup	113

8.6.6	Start Form Setup.....	113
8.6.7	Key Lock.....	113
8.6.8	Handler Setup.....	114
8.6.9	Beeper	115
Chapter 9	Programming Commands.....	116
9.1	Remote Control	116
9.1.1	Types of Remote Control	116
9.1.2	About the SCPI Commands	117
9.1.3	Programming Examples	118
9.2	Command Reference	121
9.2.1	Symbolic Conventions	121
9.2.2	Commonly Used Standard Commands	122
9.2.3	Public Commands	124
9.2.4	Point Measurement and List Command	136
9.2.5	Trace Sweep Command.....	192
Chapter 10	Handler Instructions for Use	292
10.1	Definition description.....	292
10.1.1	Signal line definition	292
10.1.2	Electrical Characteristic	297
10.2	Handler interface board circuit.....	298
Chapter 11	Technical indicators	301
11.1	Definition	301
11.2	Basic Measurement Feature	301
11.3	Signal source characteristics	301
11.4	Scan feature.....	304
11.5	Trigger function.....	304
11.6	Measurement time/average	304
11.7	Measurement accuracy.....	305

Announcement

The description of the manual may not cover all contents of the instrument, and our company is subject to change and to improve the performance, function, inner structure, appearance, accessory and package of the instrument without notice. If there is puzzle caused by inconsistency of manual and instrument, then you can contact with our company by the address on the cover.

Chapter 1 Out of Box Audit

When you receive the instrument, some inspections are necessary, and the condition must be understood and available before installing the instrument.

1.1 To Inspect the package

Inspect the shipping container for damage after unpacking it. It is not recommended to power on the instrument in the case of a damaged container.

If the contents in the container do not conform to the packing list, notify us or your dealer.

1.2 Power connection

- 1) Power-supplying voltage range: 100~120Vac or 198~242Vac. Being related with the power setup on the rear panel.
- 2) Power-supplying frequency range: 47~63Hz.
- 3) Power-supplying power range: less than 80VA.
- 4) Power supplying input phase line L, zero line N, ground lead E should be as same as the power plug of the instrument.
- 5) After careful design, the instrument can reduce the clutter jamming caused by AC power terminal input, however, it should be used under the environment with low-noise. Please install power filter if being unavoidable.

Warning: In order to prevent user and instrument from being hurt by leakage, it is necessary for user to guarantee the ground line of supply power being reliably grounded.

1.3 Fuse

The instrument has installed fuse, so operators should use the installed fuse of our company.

Warning: Be sure that the location of fuse is consistent with power-supplying voltage range before charging.

1.4 Environment

- 1) Please do not operate the instrument in the place that is vibrative, dusty, under direct sunlight

or where there is corrosive air.

- 2) The normal working temperature is $5^{\circ}\text{C}\sim 40^{\circ}\text{C}$, relative humidity $\leq 75\%$, so the instrument should be used under above condition to guarantee the accuracy.
- 3) There is heat abstractor on the rear panel to avoid the inner temperature rising. In order to keep good airiness, please don't obstruct the left and right airiness holes to make the instrument maintain the accuracy.
- 4) Although the instrument has been specially designed for reducing the noise caused by ac power, a place with low noise is still recommended. If this cannot be arranged, please make sure to use power filter for the instrument.
- 5) Please store the instrument in the place where temperature is between -20°C and 60°C , humidity is less than 85%RH. If the instrument will not be put in use for a time, please have it properly packed with its original box or a similar box for storing.
- 6) The instrument, especially the test cable should be far from strong electro-magnetic field, to avoid the jamming on measurement.

1.5 Use of Test Fixture

Please use the accessory test fixture or cable, **the test fixture made by user or from other company may cause the incorrect measurement result**. The test fixture or cable should be kept clean, as well as the pin of DUT, thus to guarantee the good connection between DUT and fixture.

Connect the fixture or cable to four test terminals Hcur, Hpot, Lcur, Lpot on the front panel. As for the DUT with shielding shell, connect shielding layer or ground “ \perp ”.

Note: When test fixture or cable has not being installed, the instrument will display an unstable test result.

1.6 Warm-up

- 1) To guarantee the accurate measurement, the warm-up time is no less than 15min.
- 2) Please not turn on or off instrument frequently, in order to avoid the inner data fluster.

1.7 Other features

- 1) Power: consumption power $\leq 80\text{VA}$.
- 2) Dimension (W*H*D): $400\text{mm}\times 132\text{mm}\times 385\text{mm}$
- 3) Weight: About 13kg.

1.8 Safe Usage

Please use the power button to switch the device on and off. It is prohibited to unplug the power cord or disconnect the power supply before the device is completely turned off, otherwise it will damage the device hardware and affect the service life of the device.

It is recommended not to install other software in the device, which may affect the working status of

the device.

If you want to use this device to connect to the Internet, it is recommended to install your own antivirus software.

Chapter 2 Introduction

In this chapter, the basic operation features of STB8851 will be described.

2.1 Introduction to front panel

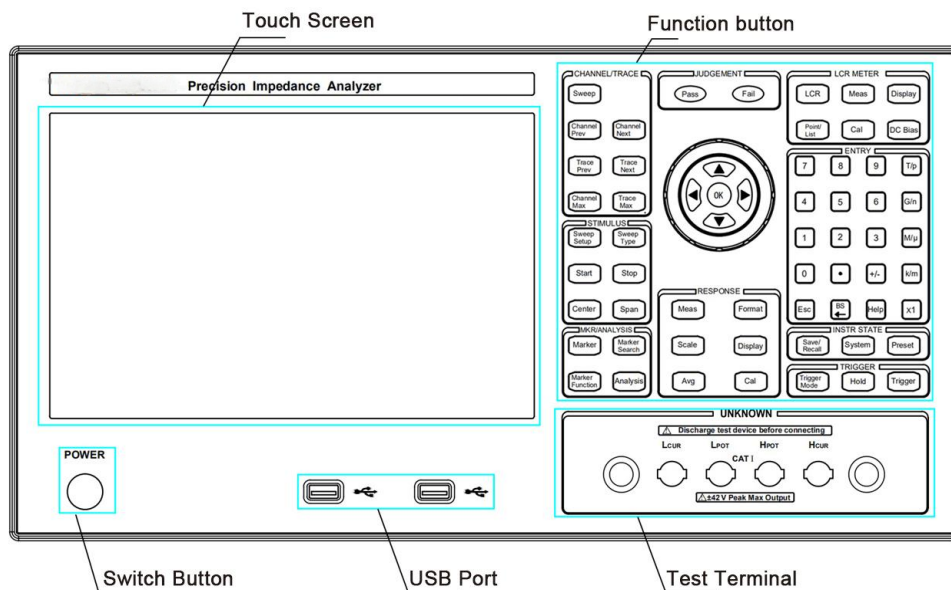

Function buttons

The keys used to implement the different functions contain the following parts:

1. CHANNEL/TRACE: switch to curve sweep function and switch channels and curves

Sweep: Switch the instrument interface to the sweep interface, and the button signal light is on.

Channel Prev: When the instrument function is trace sweep, activate to the previous channel. When this key is pressed, the active channel will change from the current channel to the channel with the channel number smaller than the current one. Only when the channel is activated, its parameters can be modified. Therefore, use this key to activate the channel before changing the channel setting.

Channel Next: When the instrument function is trace sweep, activate to the next channel. When this key is pressed, the active channel changes from the current channel to the channel with a larger channel number than the current one.

Trace Prev: When the instrument function is trace sweep, activate to the previous trace. When this key is pressed, the active trace will change from the current trace to a trace whose trace number is smaller than the current one. Only when the trace is activated, its parameters can be modified. Therefore, use this key to activate the trace before changing the trace settings.

Trace Next: When the instrument function is trace sweep, activate to the next trace. When this key is pressed, the active trace changes from the current trace to the trace with a larger trace number than the current one.

Channel Max: When the instrument function is trace sweep, the display window of the selected

channel will be switched between maximum display and normal display. When set to normal display, all set channels (whether activated or not) are displayed separately on the screen; when set to maximize display, the display window of the active channel occupies the entire display area, and the inactive channel is no longer displayed, the measurement of the inactive channel will still be performed.

Trace Max: When the instrument function is trace sweep, the display state of the active trace is switched between maximum display and normal display. When set to normal display, the traces with settings (whether activated or not) will be displayed in the channel display window; when set to maximum display, only the activated traces will be displayed in the channel window, and other districts and counties will no longer be displayed. Measurements that do not display a trace will still be performed.

2. STIMULUS : parameter setting of the trace stimulus source

Sweep Setup: When the instrument function is trace sweep, open the sweep setup menu in the menu bar, you can set the signal source parameters, sweep time, number of trace points, etc.

Sweep Type: When the instrument function is trace sweep, open the sweep mode setting menu in the menu bar to change the sweep mode of the current channel.

Start: When the instrument function is trace sweep, open the sweep range menu in the menu bar, and place the cursor in the sweep start value input area to set the start value of the sweep range.

Stop: When the instrument function is trace sweep, open the sweep range menu in the menu bar, and place the cursor in the sweep end value input area to set the end value of the sweep range.

Center: When the instrument function is trace sweep, open the sweep range menu in the menu bar, and place the cursor in the sweep center value input area to set the center value of the sweep range.

Span: When the instrument function is trace sweep, open the sweep range menu in the menu bar, and place the cursor in the span input area to set the sweep range.

3. MKR/ANALYSIS : Marker and Trace Analysis

Marker: When the function of the instrument is trace sweep, open the marker setting menu in the menu bar, you can set the marker such as the switch of the marker and the position of the marker can be changed by inputting the value of the stimulus value. You can place 10 markers on each curve.

Marker Search: When the instrument function is trace sweep, open the marker search menu in the menu bar, and the operation menu can move the marker to a specific point on the trace (maximum point, minimum value point, extreme value point and specific test value point) .

Marker Function: Open the marker function menu in the menu bar, and the operation menu can set the sweep range, switch statistical data display, etc. according to the marker position.

Analysis: When the function of the instrument is trace sweep, open the trace analysis menu in the menu bar and the operation menu can perform the sorting settings in the scanning, as well as the analysis and simulation of the equivalent circuit.

4. RESPONSE : used to set the response for the instrument measurement data

Meas: When the instrument function is trace sweep, open the measurement setting menu in the menu bar, and the operation menu can set the measurement parameters of each trace, and switch the display of offset monitoring.

Format: When the instrument function is trace sweep, open the ordinate format menu in the menu bar, and the operation menu can change the ordinate type of each trace.

Scale: When the instrument function is trace sweep, open the coordinate axis setting menu in the menu bar, and the operation menu can set the vertical coordinate distribution and scaling (including reference position, coordinate division, etc.) of each trace.

Display: When the instrument function is trace sweep, open the display setting menu in the menu bar, you can specify the display mode of channels and traces, set the number of traces, set the value memory, etc.

Avg: When the function of the instrument is trace sweep, open the measurement speed menu in the menu bar, and you can set the trace sweep speed, the number of sliding averages, and the switch.

Cal: When the instrument function is trace sweep, open the user calibration interface in the menu bar, and user calibration can be performed.

5. LCR METER : switch the instrument function to the bridge function, and the corresponding function keys

LCR: Switch the instrument interface to the point measurement interface, and the button signal light is on.

Meas: When the instrument function is point measurement, open the measurement setting menu in the menu bar, and you can modify the measurement frequency, range, trigger mode, signal source and other parameters.

Display: When the instrument function is point measurement or list sweep, open the measurement parameter setting menu in the menu bar, and you can set all the current measurement parameters.

Point/ List: Switch between point measurement interface and list sweep interface on the screen.

Cal: switch to the user calibration interface, user calibration can be performed.

DC Bias: The switch that loads the bias voltage, and the signal light will be on and off according to the switch state.

6. ENTZR : Keys related to data entry

0, **1**, **2**... **9**: Numeric keys, used to input corresponding numbers.

+ / -: Modify the sign of the input value.

T / p, **G/n**, **M / μ** , **k / m**, **x1**: Order of magnitude keys, used to input the corresponding order of magnitude unit. When the order of magnitude key is pressed, one of the two order-of-magnitude units in the key name is automatically selected according to the entered parameter. The x1 key does not enter any units.

Esc: Cancel, which is used to cancel operations in time-consuming operations such as calibration,

and to cancel the input and restore the previous value during numerical input.

BS : Backspace key, used to backspace while typing.

Help: Call out the help document, which can be used to unlock the screen and front panel when they are locked.

7. INSTR STATE : the setting button of the instrument state function

Save/Recall: Open the save and load menu in the menu bar (bridge and sweep are different menus), you can save and load measurement parameter settings and measurement results.

System: Open the system settings menu in the menu bar, you can perform various system settings.

Preset: After the key is pressed and confirmed, the instrument will return to the initial state.

8. TRIGGER : Trigger related settings of the instrument

Trigger Mode: Open the trigger setting menu and set the trigger mode.

Hold: Set the current measurement mode to hold state.

Trigger: Make a trigger.

9. JUDGEMENT : Display of sorting results, non-operation keys

Pass: When the sorting is passed, the signal light is on.

Fail: When the sorting fails, the signal light is on.

10. Direction keys and dial: used to move the input cursor and adjust the input value.

Scroll wheel: When inputting numerical value, increase or decrease the input numerical value with a smaller division value.

Up and down keys: When entering numerical values, increase or decrease the entered numerical value with a larger division value.

Left and right keys: Move the input cursor left and right when entering numerical values.

Switch button

This button is used to switch the instrument on and off. The button light illuminates when the instrument is turned on.

Touch screen

STB8851 is equipped with a 10.1 -inch touch screen for displaying numerical values, traces, division values, setting values, keys, and other measurement-related information. You can operate the keys on the screen by clicking with your finger. To learn more about touch screens, see the "Display Areas" section.

Warning: Do not use sharp objects (such as toothpicks, pen tips, screwdrivers, etc.) to press on the touch screen surface. Pressing the screen with a sharp object may damage the screen or cause dead spots on the screen.

Note: The ratio of effective dots on the touch screen should be greater than 99.998 %, and the dead dots less than 0.002 % are not considered screen damage.

Test end

The four-terminal test terminal is used to connect the four-terminal test fixture or test cable to measure the DUT.

Current excitation high side (Hcur);

Voltage sampling high-end (Hpot);

Voltage sampling low end (Lpot);

Current excitation low side (Lcur).

USB interface

USB interface can be used to connect USB devices, such as mouse, keyboard, storage device, etc.

2.2 Introduction to rear panel

Figure 2-2 shows the rear panel of STB8851.

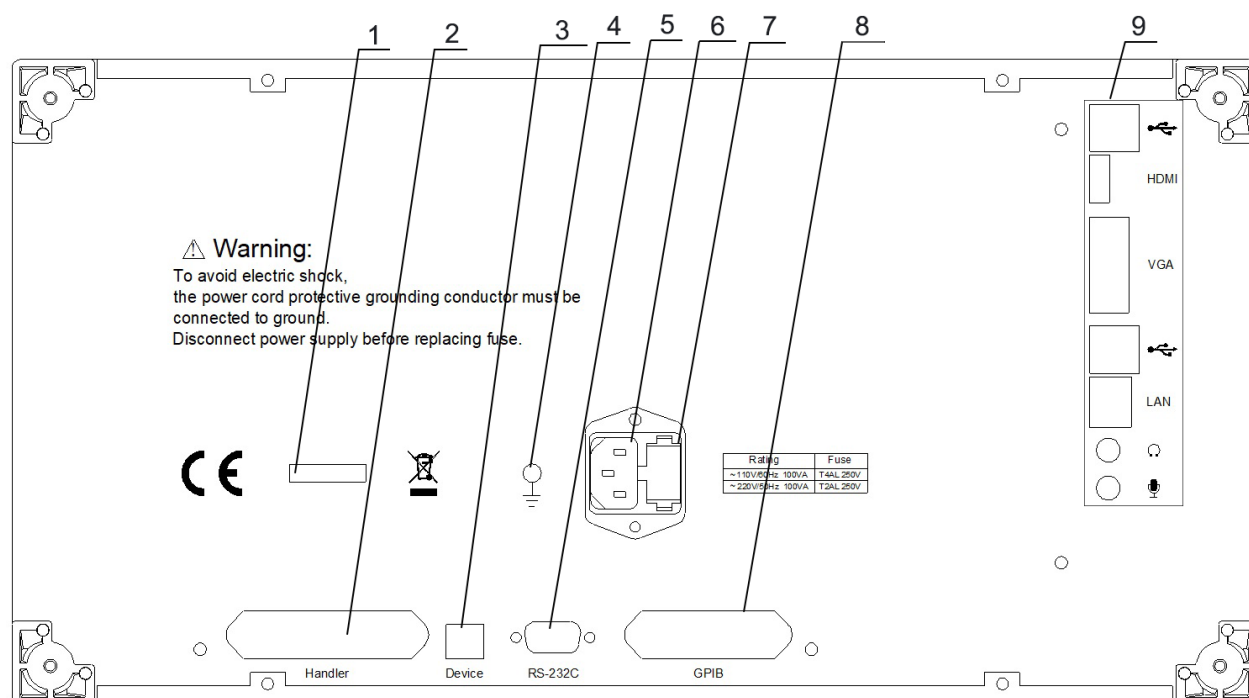

Figure 2-2 Rear panel

1. Serial label: Indicate the production date, manufacturer, instrument number and other information;
2. Handler interface: Handler signal input and output;
3. U SB Device interface: U SB communication interface to realize communication with other devices;
4. Ground terminal: connected to the chassis, used to protect or shield the ground connection;

5. RS232 serial interface: serial communication interface, realize communication with other equipment;
6. Power socket: used to supply AC power to the device;
7. Fuse holder: used to install fuse, protect the instrument, can switch 1 10V/220V ;
8. G PIB interface: G PIB interface realizes communication with other devices;
9. Main board interface: The general interface of the computer main board, including USB port, video output port (the screen can be put on other video output devices), audio input and output port, LAN port (network interface, realize the communication and control of network system).

2.3 Screen Area

2.3.1 Screen interface display

STB8851 includes a variety of measurement interface displays and setting interface displays. The main function interfaces are shown in the following table:

Display type		Function
Measurement interface	Point measurement interface	The parameters of the measured point and the measurement results are displayed in the interface
	List measurement interface	All measurement points and their measurement results are displayed in a table on the interface
	Sweep measurement interface	The curve drawn by the measurement points and their measurement results is displayed in the coordinate axes of the interface
Set interface	User Calibration Interface	All user calibration point settings and calibration values are displayed in a table in the interface
	Accessory Calibration Interface	Step prompts for user fixture calibration are displayed in the interface
	Point comparator setting interface	In the interface, the setting value of point measurement and comparator is displayed
	List setting interface	All the points to be measured and their setting parameters are displayed in the table of the interface, and all points are arranged in order in the

		table.
List quick edit interface		Quick setup of measuring points for list sweep
List comparator setting interface		The setting value of list sweep comparator is displayed in the interface
Sweep comparator setting interface		The trace sweep comparator parameter settings are displayed in the table of the interface
Sweep segment setting interface		The settings of the trace sweep segment are displayed in the table of the interface

2.3.2 Point measurement display interface

Press the LCR button on the front panel, the point measurement interface will be displayed on the screen, as shown in the figure below:

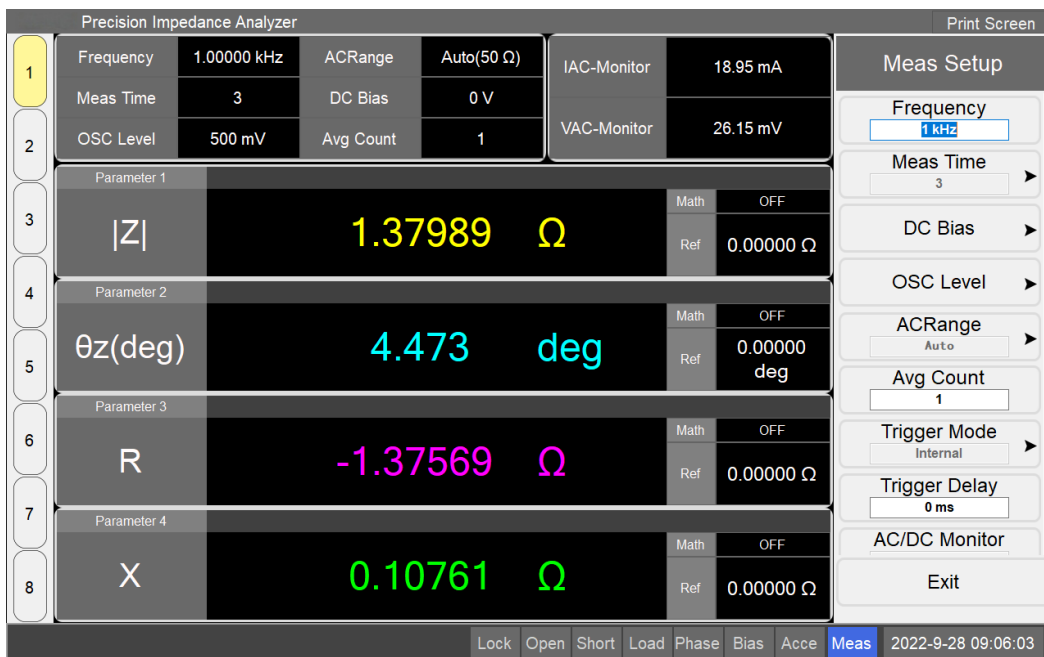

Channel number

The highlighted channel is the currently active channel. There can be 8 channels in the point measurement mode at the same time, and each channel can set different measurement conditions (frequency, level, bias, etc.) and measurement parameters. Channels can be switched by clicking the channel number button.

Measurement conditions

The measurement conditions of the current channel are displayed in the area, including measurement frequency, measurement time, OSC level, AC range, DC bias, and average count. These variables can be changed in the Measurement Setup menu. Clicking a control in this area, the menu area will open the "Measurement Settings" menu and automatically navigate to the clicked

variable.

AC and DC monitor

It displays the currently measured AC/DC current and voltage monitoring values. The monitor mode can be changed in the "Measurement Settings" menu; click on this area, the menu area will open the "Measurement Settings" menu.

Menu name

It displays the name of the current menu, displayed at the top of the menu.

Menu

It displays the currently opened menu. The menu contains different types of buttons: normal buttons, editable content buttons, selection buttons, etc. An arrow on the right side of the button means that pressing the button will open a sub-menu; a black square on the left side of the button means the button is currently selected.

Time display

It displays the current system date and time.

Device status

Various current measurement states are displayed. As shown in the table below:

Display	Definition
Open (shown in blue)	User open calibration is turned on
Short (shown in blue)	User short calibration is turned on
Load (shown in blue)	User load calibration is turned on
Phase (shown in blue)	User phase calibration is turned on
Bias (shown in red)	Bias voltage is turned on
Lock (shown in red)	Front panel and screen operations are locked
Pass (shown in green)	Comparator is passed
Fail (shown in red)	Comparator is failed
Acce (shown in blue)	User accessory calibration is turned on
Meas (shown in blue)	The current trigger mode is internal trigger (continuous measurement)
Manual (shown in blue)	The current trigger mode is manual trigger
External (shown in blue)	The current trigger mode is external trigger
Bus (shown in blue)	The current trigger mode is bus trigger

Measurement parameters and results

It displays the current measurement parameters and measurement results. STB8851 supports simultaneous display of up to 4 measurement parameters. Click this area to modify measurement parameters and display settings for measurement results (such as reference values, math operations, significant digits, etc.).

2.3.3 List measurement display interface

The list measurement display interface is shown in the following figure:

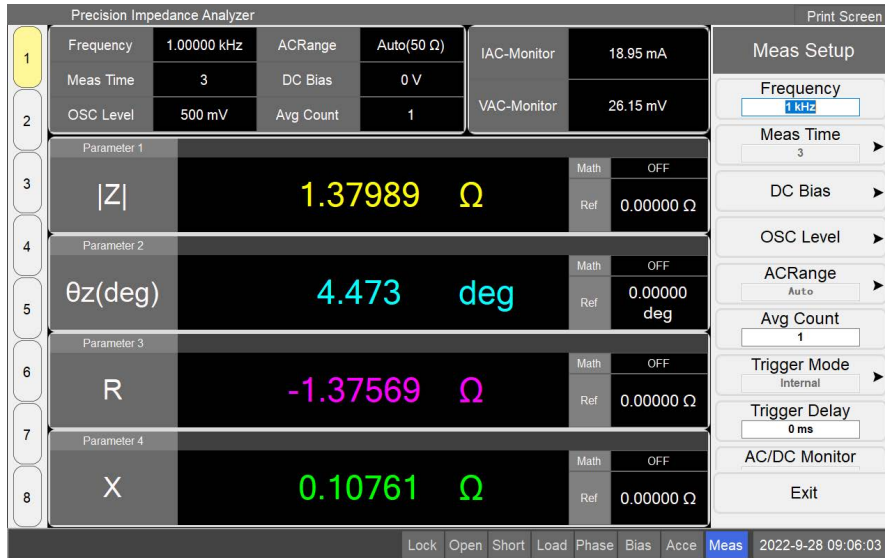

Channel number

The highlighted channel is the currently active channel. There can be 8 channels in the list mode at the same time, and each channel can set different environmental variables (frequency, level, bias, etc.) and measurement parameters. Channels can be switched by clicking the channel number button.

Measured point serial number

The serial number of the measured point is displayed, which can be modified in the list setting page.

Measurement conditions

It displays the measurement conditions of the measured point, including: measurement frequency, average count, OSC level, AC range, and DC bias. These parameters can be modified in the list settings page.

Measurement parameters and measurement results

The current measurement parameters and measurement results of the measured point are displayed in sequence. The parameters to be measured can be changed in the measurement parameters menu.

2.3.4 Sweep measurement display interface

Press the **Sweep** button, and the sweep measurement interface will be displayed on the screen. The main part of the interface is the channel window, as shown in the following figure:

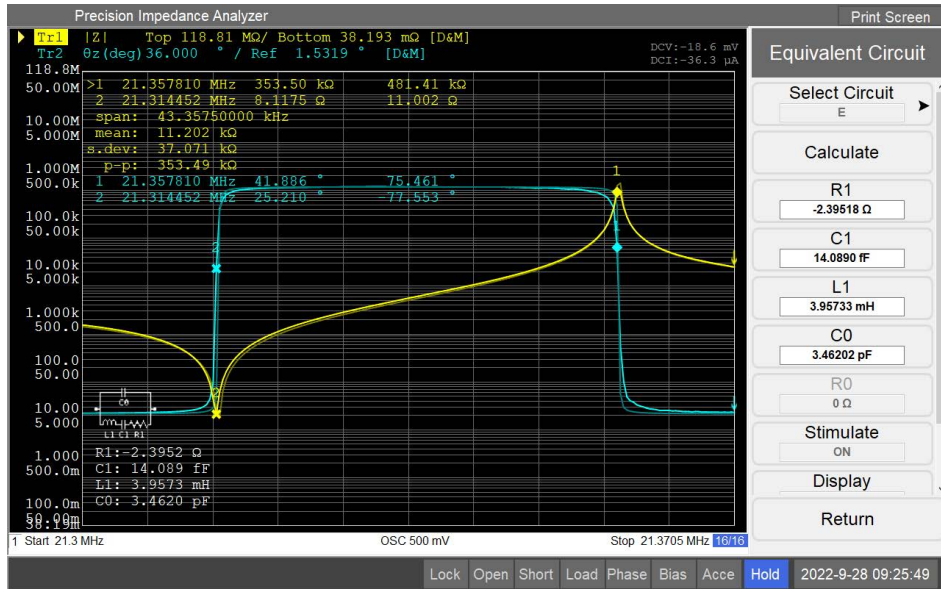

Moving average state

This status is only displayed when moving average is turned on. The display format is n/m, where m is the set number of moving averages, and n is the moving average count. The moving average switch and counts can be changed in the measurement speed menu.

Channel number

The serial number of the channel displayed in the current window. The active window can be switched by pressing **Channel Prev** and **Channel Next** buttons, and you can switch to the channel directly by clicking the channel window.

DC monitor

When the DC monitor is turned on, the current measured DC level and the current monitor value are displayed.

Equivalent circuit simulation results

The selected equivalent circuit model and simulated resistance, capacitance, and inductance values are shown. This graph is displayed on the channel window when the equivalent circuit result display is turned on.

Ordinate label

The tick distribution of the ordinate axis of the coordinate system is displayed. When the measured trace exists in the coordinate system, this area will display the set ordinate scale label of the currently active trace. The ordinate reference value (highlighted) can be changed in the Axis Settings menu. At the same time, you can also set the ordinate value of the selected marker as the reference value in the marker function menu. The ordinate scale distribution, ordinate reference value, etc. can also be manually changed or automatically set in the axis setting menu.

Marker

The marker is used to read measurements on the trace. Up to 10 markers can be displayed on a trace. The shape of marker 1 in the figure represents the activated marker, and the shape of marker 2 is the inactive marker. The active marker can be toggled through the marker settings menu or by clicking on the marker value field. At the same time, you can also modify the position of the marker in the

marker setting menu, and drag the screen with your finger in the coordinate system to directly drag the position of the activated marker.

Marker value

It displays the abscissa values of all current markers and the degrees of measurement values on each trace. The ">" symbol before the marker serial number indicates that the marker is the currently activated cursor. Clicking on this area will switch the active marker to the next marker.

Marker Statistics Parameters

It displays statistics (range, average, standard deviation, peak-to-peak) for all points of the current trace between marker 1 and marker 2. The display can be turned on or off in the marker function menu. When the display is turned on, if marker 1 and marker 2 are not turned on, marker 1 and marker 2 are automatically turned on.

Measurement parameters

It displays the measurement parameters of the current trace. Measurement parameters can be changed in the measurement setup menu.

Signal source voltage/DC bias/non-sweep frequency

The signal source voltage, DC bias and frequency of the sweep are displayed, which will be displayed differently in different sweep modes, as shown in the following table:

Sweep mode	Display type
Sweep frequency	Signal source voltage and bias voltage (bias voltage on)
Sweep signal source level	Non-sweep frequency and bias voltage (bias voltage on)
Sweep bias voltage	Non-sweep frequency and signal source voltage

Ordinate scaling value

It displays the current ordinate scaling value of each trace. When the vertical axis of the trace is the linear axis, the display format is "Scale/Reference"; when the vertical axis of the trace is the logarithmic axis, the display format is "Top/ Bottom ";

Span

It displays the sweep range of the current channel.

Trace number

It indicates the trace name and trace number (eg Tr1) in the current channel. The trace name is consistent with the color of the trace itself. The triangle symbol before the name indicates that the trace is the active trace, and the settings in the current channel coordinate system are based on the active trace. The activated traces can be switched via the **Trace Next** and **Trace Prev** buttons on the front panel, or by clicking on the trace number area in the screen.

Trace state

The possible states for each trace are shown in the following table:

Classification	Status (enclosed in [])	Meaning
When the trace math operation is set to OFF , it will be distinguished according to the different display states of the trace and the stored trace.	no state	Trace display is on, the stored trace display is off
	M	Trace display is off, the stored trace display is on
	D &M	Trace display on, the stored trace display on
	off	Trace display is off, the stored trace display is off
When the trace display is on and the math operation of the trace is not OFF, it is distinguished according to the math operation of the trace. When the stored trace display is on, it is the state inside ()	D +M (D+M&M)	Math operations: Calculate data + store data
	D- M (D - M&M)	Math operations: Calculate Data - store data
	D* M (D * M&M)	Math operations: Calculate data * store data
	D/ M (D/M&M)	Math operations: Calculate data / store data

2.3.5 User Calibration Interface

The user calibration page displays the calibration settings made by the user, and the user can perform specific calibration operations and view calibration data. The specific interface is shown in the following figure:

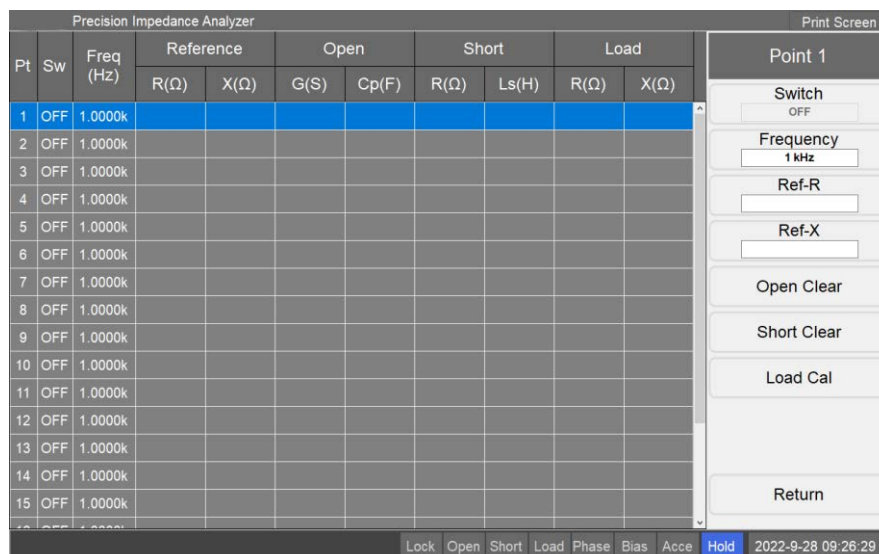

Calibration point list

It displays the status of all user calibration points and the calibration data that has been performed. STB8851 provides a total of 20 user calibration points; each point has an independent switch and frequency settings. At the same time, the list also displays the load reference value, open circuit calibration value, short circuit calibration value and load calibration value of the calibration point. Click the row of the calibration point to open the corresponding calibration point setting menu.

Calibration point setup

The selected calibration point can be set. Settings include switching, measurement frequency, and

load reference. Among them, if the calibration point is turned off, then in the measurement, the calibration point will not work. The load reference parameter will depend on the load type setting.

Point calibration

Point calibration can be performed on the currently selected calibration point, including open clear, short clear, and load calibration. These calibration data will only be used in the measurement if the calibration point is turned on.

2.3.6 Accessory Calibration Interface

The main function is to guide the user to perform accessory calibration, as shown in the following figure:

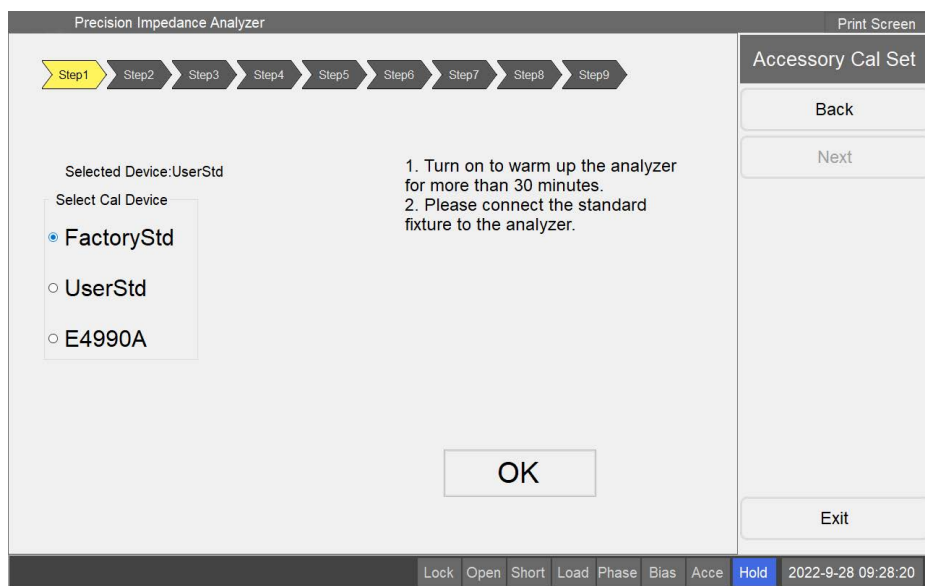

Calibration steps

The overall progress of the calibration is displayed. Unfinished steps are light gray, completed steps are dark gray, and currently active steps are light yellow. You can navigate to a completed step by pressing the button in the menu bar or click the step label, and re-calibrate the step (except for some special steps).

Calibration Guide

Operational guidance for the current calibration step. Follow the instructions to complete the fixture calibration.

2.3.7 Point measurement and comparatpor setting interface

The point measurement and comparator interface shows the conditions for point measurement and comparator, as shown in the following figure:

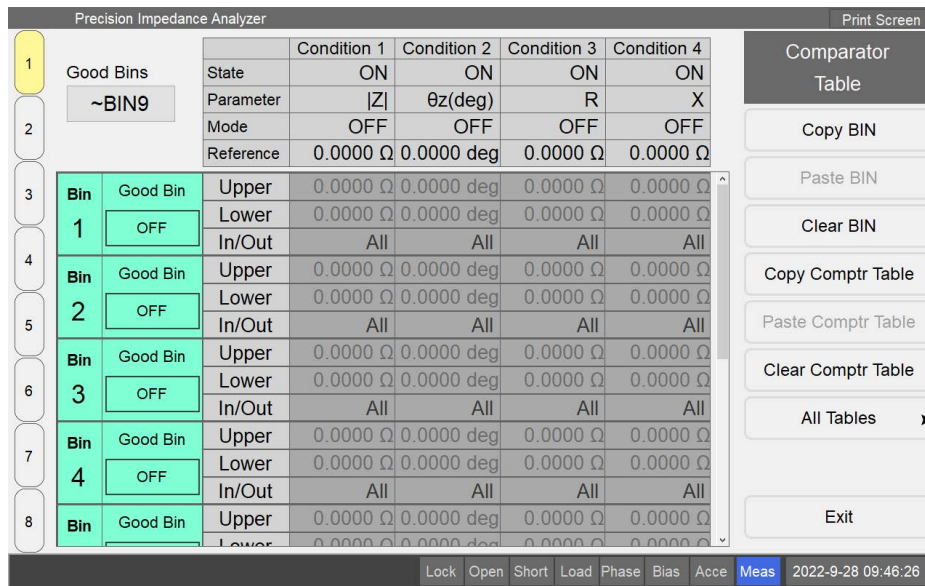

Set serial number

The comparator page also has 8 setting pages, and 8 different comparator settings can be performed at the same time. The comparator setting page corresponds to the channel of the point test, that is, the comparator setting with serial number 1 will be applied to the channel 1 of the point test, and so on.

Good BIN Setup

It is used to set good BINs and bad BINs. As shown in the figure, it is set to ~ BIN3, that is, BIN1-BIN3 are good BINs, and BIN4-BIN10 are bad BINs.

Channel state

Comparator state (channel switch, etc.) can be set and displayed. When the BIN is OFF, it is considered that the BIN does not exist during sorting. There are a total of 10 sorting BINs, good BINs are displayed in green, and bad BINs are displayed in red.

Comparator setup

It is used to set comparator state. There are 4 comparator states for comparator at the same time, and each state has independent switches, comparator parameters, operation types, reference values, etc. When the comparator state is turned off, the corresponding state settings and comparator conditions cannot be set. In the comparator table menu, there will be more serial number settings for the points to be sorted.

Comparator conditions

Comparator settings for each BIN can be made. The BIN comparator conditions correspond to 4 comparator settings, and the comparator qualified interval, upper limit and lower limit can be set. If the test value is within the qualified range, the sorting is passed, otherwise it is failed.

2.3.8 List setting interface

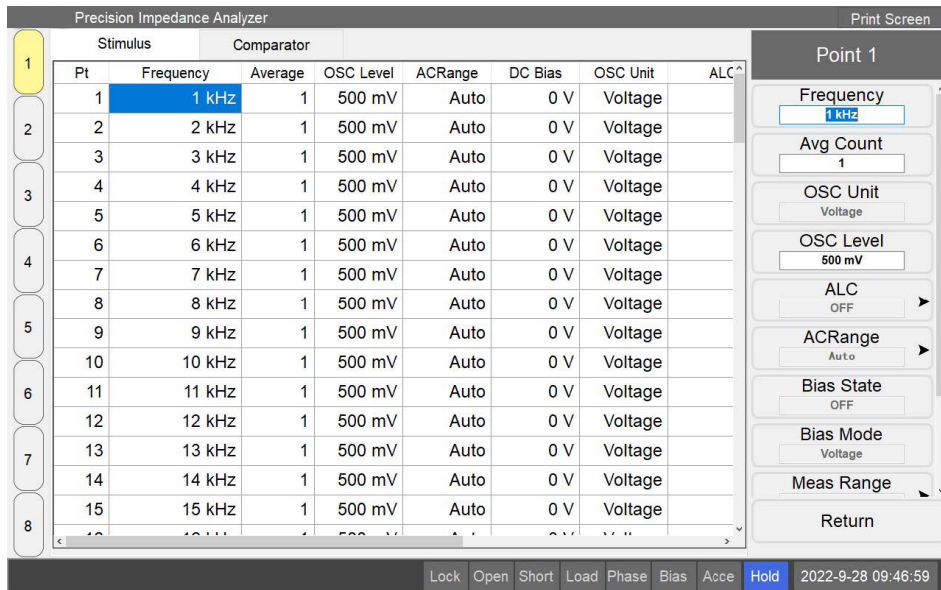

Desktop tab

Switch to the current setting page. You can switch to the stimulus setting interface and the comparator setting interface.

Points to be measured

It displays all the points to be measured and their measurement parameters in the current channel. Click the row of the point to be measured (except the first column), the menu bar will open the setting menu corresponding to the point to be measured, and click the first column to return to the root menu.

Point parameter setting

The measurement parameters of the current point can be changed.

2.3.9 List quick edit interface

The list quick edit page can quickly set the measurement points.

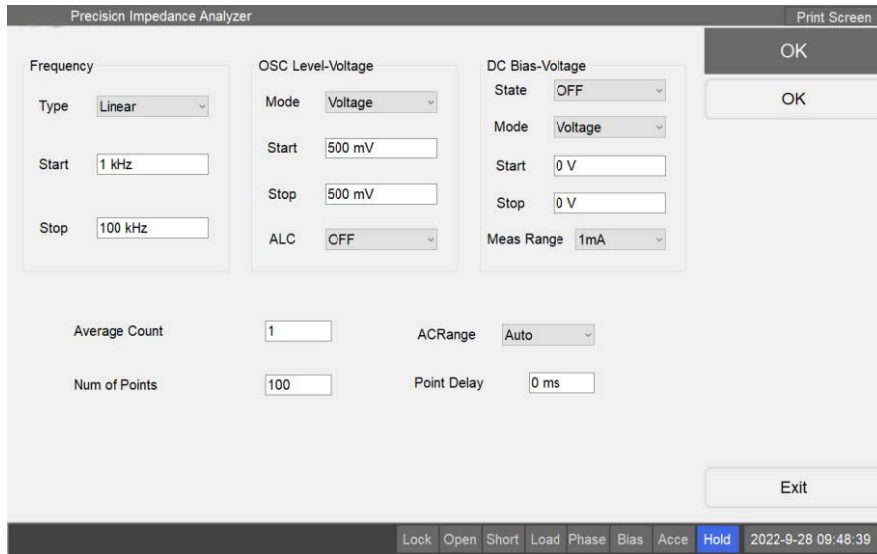

Quick settings area

Quickly set measurement point parameters.

Setup is complete

Confirm the setting of the stimulus measurement point, save the set data, exit the current interface and return to the stimulus setting interface.

2.3.10 List comparator setting interface

Please refer to the point measurement comparator setting interface.

2.3.11 Sweep comparator setting interface

Comparator condition settings for sweep test. Before entering this page, first of all, it is necessary to save the current trace to the storage data as the reference data for comparator. The sweep comparator setting page is shown as below:

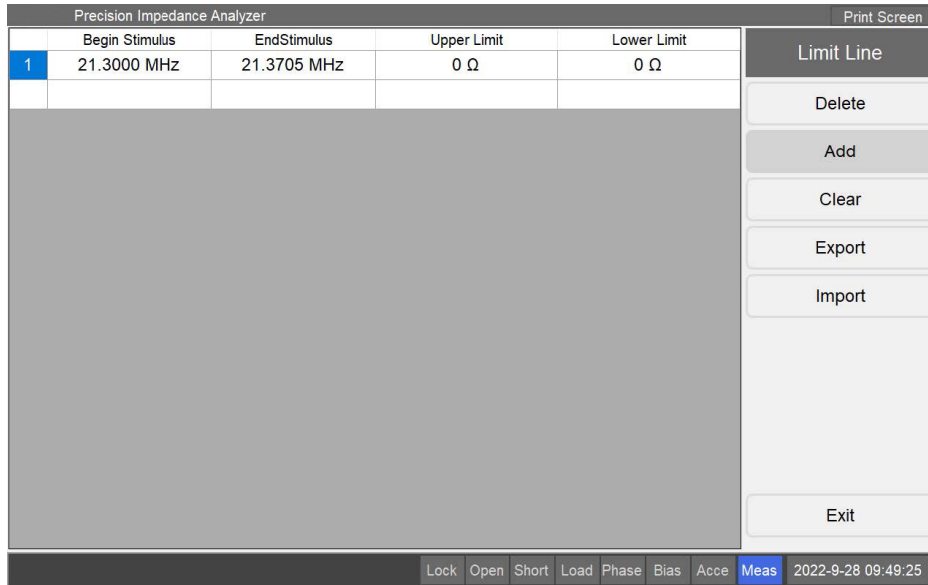

Comparator condition list

The comparator conditions that have been set are displayed. Different comparator conditions are sorted according to frequency, and the frequency range does not exceed the sweep frequency range. Click the frequency criteria (except the first column) to open the comparator settings menu; click the first column to return to the root menu.

Comparator condition setting

Set the selected comparator conditions. You can set the comparator type; begin stimulus and end stimulus, upper limit and lower limit. Among them, the setting of the comparator upper and lower limits is related to the selected comparator type. When the comparator type is numeric, to set the numerical value; when the sorting type is percentage, to set the percentage.

2.3.12 Sweep segment setting interface

This screen shows the settings for the sweep frequency segment. This setting only takes effect when the sweep mode is set to segmented sweep. The sweep segment interface is shown in the following figure:

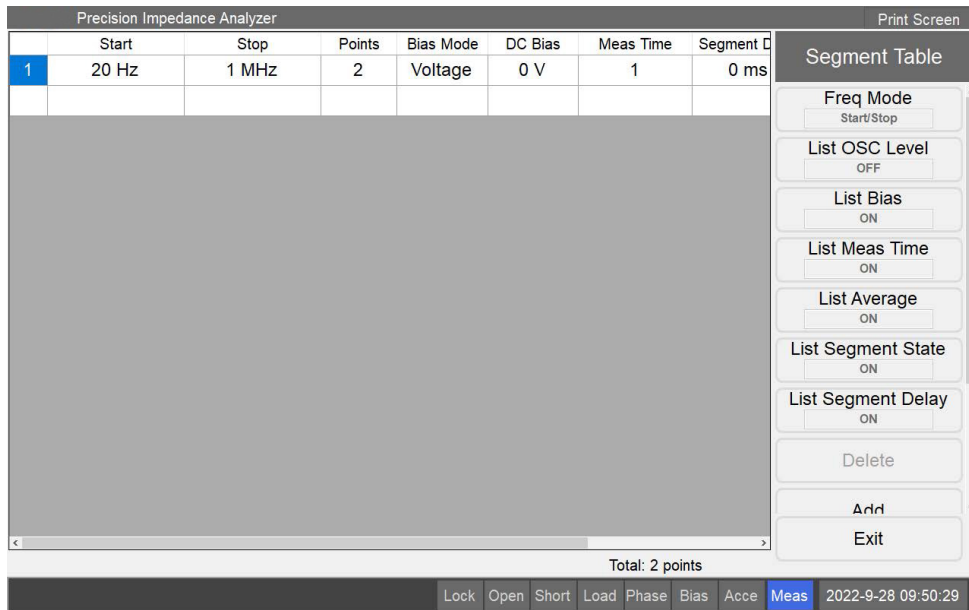

Segment table

All segmentation settings are displayed. All segments are sorted by frequency, and the start frequency of the next segment is not lower than the end frequency of the previous segment, and not higher than the end frequency of the same segment. Except for frequency and number of points, the display of other parameters needs to turn on the corresponding switches in the root menu. Click the segment condition (except the first column) to open the corresponding segment setting menu; click the first column to return to the root menu.

Segment setting

The selected segment can be set, including frequency (the format includes start/stop and central/span, which can be switched in the root menu), number of points, level, bias, etc. Among them, except the frequency and the number of points, other parameters can only be set by turning on the corresponding switch in the root menu.

Points

It shows the point statistics for the current segment setting. The total number of points must not be less than 2, and at least one point is required under each segment setting.

Measurement example

This section will guide you through a measurement example to understand the basic operation of the STB8851. If you are a new user of STB8851, this part can help you get familiar with STB8851 quickly.

2.4 Measurement examples

This section will guide you through the basic operation of the STB8851 with a single measurement example. If you are new to the STB8851, this section will help you to quickly become familiar with STB8851.

2.4.1 Equipment requirements

In order to be able to complete all the steps of this example, you need to prepare the following measurement equipment.

STB8851;

SBF0005C fixture;

100 ohm resistor;

Standard open and short test pieces

Crystal resonators.

2.4.2 Measurement preparation

Complete the preparation of the STB8851 for measurement by following the steps below. This ensures that the STB8851 is properly installed and set up.

2.4.2.1 Connection fixture TH26005C

Connect the fixture TH26005C to the STB8851:

1. Align the 4 test ends of the SBF0005C with the test ends on the STB8851, and gently insert the fixture until the two test ends are fully fitted;
2. Turn the rotating operating lever on the test end of the SBF0005C fixture clockwise to ensure the stability of the fixture during measurement;
3. When removing the clamp, perform the above steps in reverse order.

2.4.2.2 Turn on the power

STB8851 can be activated by pressing the switch button. After startup, the program of STB8851 will start automatically, and check whether various files are completed during startup. After everything is ready, the device first enters the point measurement interface.

Note: please do not shut down the program by directly cutting off the power supply, which may cause irreversible damage to the electronic components of the STB8851.

2.4.2.3 Initialize the instrument

Preset initialization restores the device to the factory settings, which can reset the previous measurement conditions and parameter settings to avoid the subsequent measurement being affected by the previous measurement. The initialization function can be set to restore to factory settings or user settings (user setting files are required), and the system defaults to factory settings. This setting

can be changed in the system settings.

Press **Preset** on the front panel and click OK on the screen to restore the device to factory settings.

2.4.3 User measurement calibration

Perform user calibration before measurement. On the point measurement page, click **Cal** in the upper right corner of the front panel to enter the user calibration page.

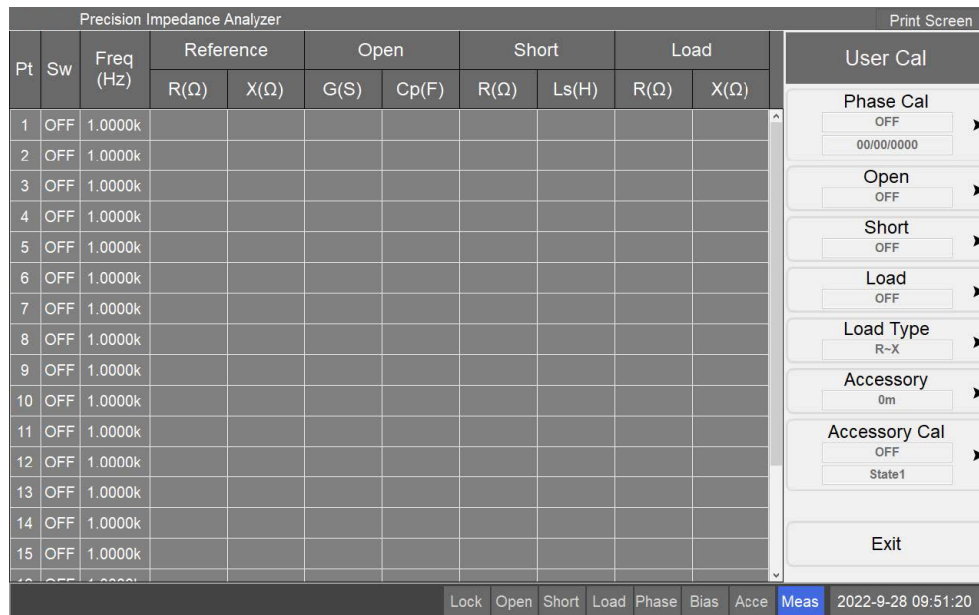

2.4.3.1 User full frequency open clear

1. Click **Open** on the user calibration menu to enter the open calibration menu;
2. Install the standard open measuring piece on the SBF0005C fixture, and click **All frequency clear**;
3. After the full frequency clear is completed, the data will be saved and the user open calibration will be turned on. Click **Return** to return to the user calibration menu.

2.4.3.2 User full frequency short clear

1. Click **Short** on the user calibration menu to enter the short calibration menu;
2. Install the standard short measuring piece on the SBF0005C fixture, and click to **All frequency clear**;
3. After the full frequency clear is completed, the data will be saved, and the user short calibration will be turned on. Click **Return** to return to the user calibration menu.

2.4.3.3 User Phase Calibration

1. Click **Phase Cal** on the user calibration menu to enter the Phase Calibration menu;
2. Install the standard open measuring piece on the SBF0005C fixture, click **Start Phase Cal**;
3. After the calibration is completed, the user phase calibration will be turned on. Click **Return** to return to the user calibration menu.

2.4.3.4 User Accessory Calibration

1. Click **Accessory Cal** on the user calibration menu to enter the accessory calibration menu;
2. Click the button to select the file location to be saved after calibration. If there is a fixture calibration file in the selected location, the file will be overwritten after the calibration is completed (if there is an * in the name of the file location button, it means an existing calibration file);
3. Click **Start Accessory Cal** to enter the accessory calibration page, and complete the calibration process according to the guidance on the page;
4. After calibration is complete, user accessory calibration will be turned on. Click **Return** to return to the user calibration menu.

Note : Because the accessory calibration includes open-short clear and phase calibration, when the user accessory calibration is turned on, the user's open calibration, short calibration, and phase calibration will be automatically closed; correspondingly, the user's open calibration, short calibration or phase calibration is turned on, the user accessory calibration will be turned off.

2.4.4 Point measurement example

This part demonstrates the point measurement function of STB8851, connect the 100Ω resistor to the accessory, and press **LCR** on the front panel to enter the point measurement page.



2.4.4.1 Set measurement conditions (frequency/average count/signal source voltage, etc.)

According to user needs, set different measurement conditions, follow the steps below:

1. Press **Meas** in the upper right corner of the front panel to enter the measurement setting menu;
2. Select **Frequency** in the measurement setting menu, and press **1** > **M/μ** on the front panel to set the measurement frequency to 1 MHz ;
3. Select **Avg Count** in the measurement setting menu, and press **5** on the front panel to set the measurement average count to 5;
4. Select **OSC Level** in the measurement setting menu, enter the measurement level menu, set the test voltage, and then press **return**;
5. Press **DC Bias** on the front panel to turn on the bias voltage switch;
6. Press **LCR** on the front panel to return to the point measurement menu.

2.4.4.2 Set measurement parameters

Set the measurement parameters required by the user and display them on the measurement interface. Follow these steps:

1. Click the parameter name on the screen to enter the test parameter setting interface;
2. Select and press the parameters to be displayed on the measurement interface;
3. Press **LCR** on the front panel to return to the point measurement menu .

2.4.5 List measurement example

This section demonstrates the list measurement function of the STB8851. On the point measurement page, press **Point / List** on the front panel to enter the list measurement interface.

2.4.5.1 List Measurement point setting

Set the points to be measured. Follow these steps:



1. Click **Stim Table** on the List Root on the screen to enter the stimulus setting interface;
2. Click **Quick Edit** on the stimulus setting menu on the screen to open the quick edit interface;
3. Set the interpolation mode to linear interpolation, the start frequency to 100 kHz, the stop frequency to 1 MHz, and the number of points to 10, click **OK** to quickly set 10 measurement points;
4. Click the row of each measurement point on the screen to enter the measurement point setting menu, you can set the measurement conditions of each point individually, and click **Return** to return to the measurement setting menu;
5. Click **Exit** to return to the list measurement interface.

2.4.5.2 Set measurement parameters

Set the list measurement parameters and display them in the measurement page. Follow these steps:

1. Click **Point Meas** on List Root on the screen to enter the measurement parameter menu;
2. Click the parameter button that needs to be changed to enter the parameter setting menu;
3. Select and click the measurement parameter to be set to return to List Root.

Precision Impedance Analyzer										Print Screen
Pt	Frequency	Avg	OSC Level	ACRange	DC Bias	Z	$\theta_z(\text{deg})$	R	X	
1	100 kHz	1	500 mV	Auto(50 Ω)	0 V	100.106 Ω	-0.00508 deg	100.106 Ω	-0.00887 Ω	List Root
2	200 kHz	1	500 mV	Auto(50 Ω)	0 V	100.100 Ω	-0.01344 deg	100.100 Ω	-0.02348 Ω	Point Meas
3	300 kHz	1	500 mV	Auto(50 Ω)	0 V	100.115 Ω	0.01121 deg	100.115 Ω	0.01958 Ω	Stim Table
4	400 kHz	1	500 mV	Auto(50 Ω)	0 V	100.089 Ω	0.00183 deg	100.089 Ω	0.00319 Ω	Calibration
5	500 kHz	1	500 mV	Auto(50 Ω)	0 V	100.082 Ω	0.01548 deg	100.082 Ω	0.02703 Ω	Display
6	600 kHz	1	500 mV	Auto(50 Ω)	0 V	100.091 Ω	0.04070 deg	100.091 Ω	0.07110 Ω	List Type
7	700 kHz	1	500 mV	Auto(50 Ω)	0 V	100.098 Ω	0.03763 deg	100.098 Ω	0.06575 Ω	Step
8	800 kHz	1	500 mV	Auto(50 Ω)	0 V	100.110 Ω	0.04343 deg	100.110 Ω	0.07589 Ω	List Meas Time
9	900 kHz	1	500 mV	Auto(50 Ω)	0 V	100.106 Ω	0.04718 deg	100.106 Ω	0.08244 Ω	1
10	1 MHz	1	500 mV	Auto(50 Ω)	0 V	100.100 Ω	0.06627 deg	100.100 Ω	0.11577 Ω	Trigger

Electrode: A1
Thickness: 10.000 mm

Lock Open Short Load Phase Bias Acce Meas 2022-9-28 09:54:57

2.4.5.3 Set the measurement speed

Set the measurement speed of the list measurement according to the user's requirements for measurement speed and accuracy. Follow these steps:

1. Click **Meas Time** on the List Root on the screen to enter the measurement speed menu;
2. Select and click the desired measurement speed.

2.4.6 Sweep measurement example

This part shows the trace sweep measurement function of STB8851. Connect the crystal resonator to the fixture, press **Sweep** on the front panel to enter the trace sweep measurement interface.

2.4.6.1 Set |Z|-Theta as measurement parameter

Set the measurement parameters as follows:

1. Click **Measurement** of the Sweep Root on the screen to enter the measurement setting menu, then click **Tr1 & Tr2** to enter the parameter setting menu;
2. Make sure that the selected item for **Tr1 & Tr2** is **|Z|- θ_z** (the default state is selected), so that trace 1 reflects the absolute value of the resistance value, and trace 2 reflects the phase.

2.4.6.2 Set the center and span

1. Press **Center** on the front panel to open the sweep range menu and automatically lock at **Center** ;

2. Enter the center frequency of 8MHz , and press **8** > **M/μ** on the front panel in sequence ;
3. Press **Span** on the front panel, the sweep range menu is now automatically locked in the **Span** ;
4. Enter the value range of 30 kHz, and press the **3** > **0** > **k** **√** keys on the front panel in sequence.

2.4.6.3 Set sweep speed

1. Press **Avg** on the front panel to enter the measurement speed menu;
2. Click **Meas Time**, then select and tap **3** as measurement Speed.

2.4.6.4 Set the ordinate of the $|Z|$ curve to the logarithmic distribution

1. Select trace 1 as the active curve (the measurement parameter of trace 1 is $|Z|$);
2. Press **Format** on the front panel to enter the ordinate format menu;
3. Click the **Vertical axis type** and select logarithmic axis.

2.4.6.5 Display traces in different coordinate systems

1. Press **Display** on the front panel to enter the display setting menu;
2. Press **Allocate Traces** to enter the trace assignment setting menu, select and click the coordinate system distribution button in the menu.

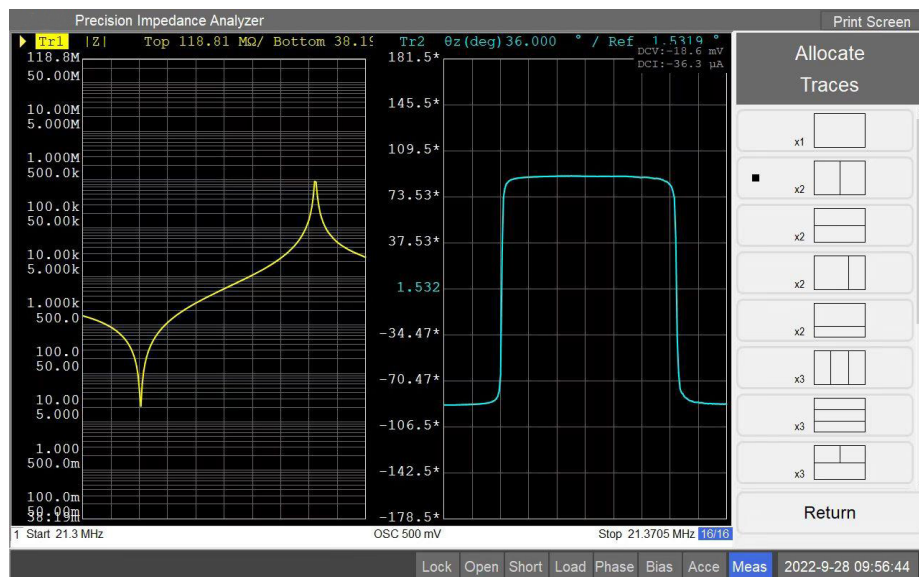

2.4.6.6 Axis auto scaling

Press **Scale** on the front panel to enter the coordinate axis setting menu, and press **Auto Scale All** for all traces.

2.4.6.7 Analysis of measurement results

Perform equivalent circuit analysis on the trace to find the resonance point of the circuit, and follow the steps below:

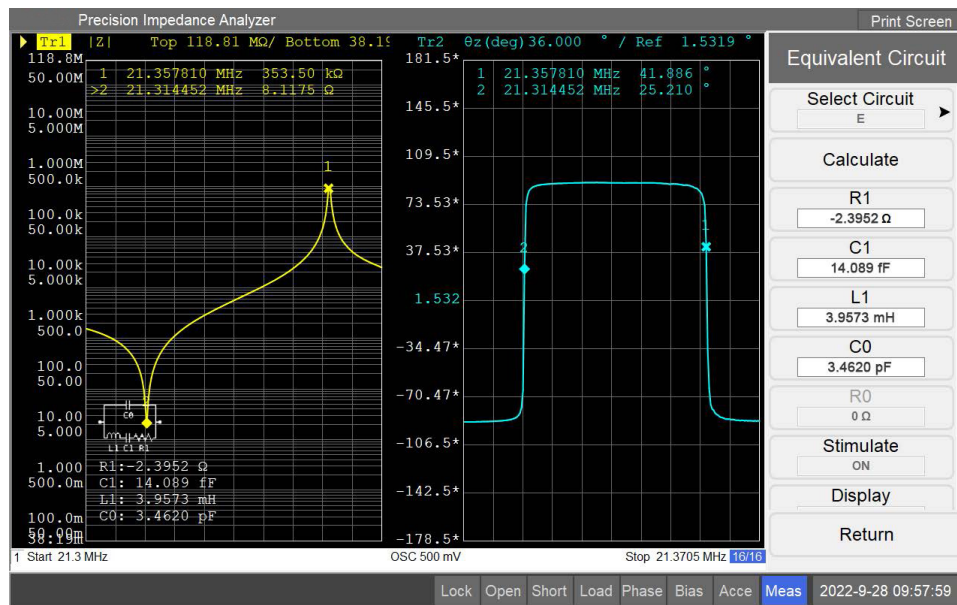

1. Press **Analysis** on the front panel to enter the trace analysis menu, and then press the **Equivalent Circuit** to enter the equivalent circuit menu;
2. Click on the screen to **Select Circuit**, select and click the Model E button;
3. Press the **Calculate** to perform an equivalent analysis on the trace, and the analog values of resistance, inductance and capacitance are displayed on the menu;
4. Turn on the **Display** button in the equivalent circuit menu, and the equivalent circuit model and simulation results will be displayed on the screen;
5. Press **Marker Search** on the front panel to enter the marker search menu;
6. Keep Tr1 as the active curve, press **Min**, the program will automatically open Tr1 and locate the minimum value of $|Z|$;
7. Click the toggle **Tacking** button to the on state. When the marker tracking is on, the program will automatically position the currently selected marker to the selected position after each sweep cycle. After one sweep period, Tr1 will be automatically positioned to the minimum value of the $|Z|$ trace;

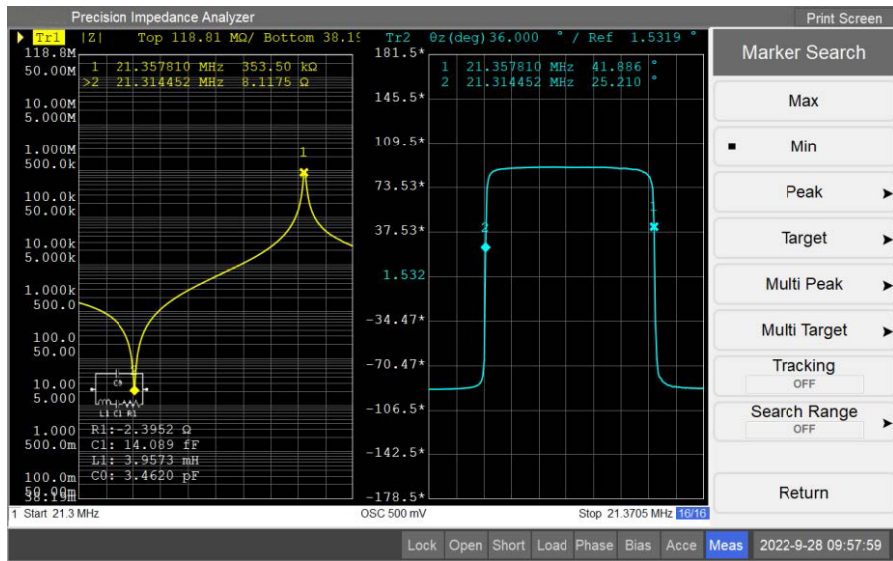

Chapter 3 User Calibration

3.1 Overview

User calibration needs to be performed by the user before starting the measurement, which can eliminate measurement errors caused by fixtures, test pieces, etc.

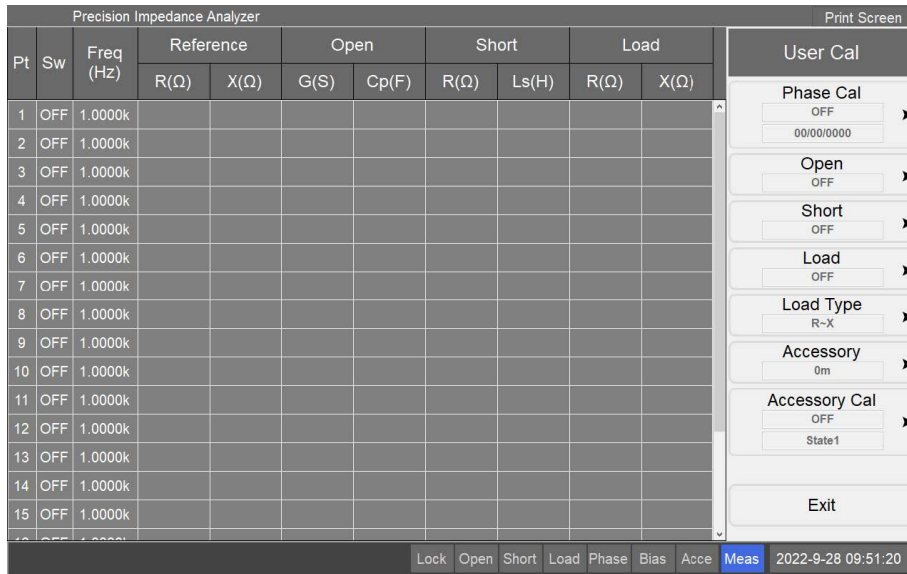

Press **Cal** on the front panel to enter into the user calibration interface. After entering, the main area on the left side of the interface is a list of calibration points. STB8851 provides 20 calibration points, whose switch, frequency, reference, etc. can be individually set; the menu area on the right side of the interface is the user calibration menu, which can perform all frequency calibration and its switch operation.

3.2 All frequency user calibration setup

3.2.1 Choose a measuring accessory

According to the currently selected measurement accessory, set the measurement accessory data in the user calibration interface. STB8851 provides several measuring accessories for selection; the default selection is 0 m. If the user uses a custom accessory to measure, or the accessory used is not in the selectable accessory options, it is recommended to set the measurement accessory to 0 m and perform accessory calibration.

Set up the measuring accessory as follows:

1. Click **Accessory** button in the user calibration menu to enter the measurement accessory menu;

2. Select and click the button corresponding to the selected measuring accessory.

3.2.2 User open calibration

3.2.2.1 Toggle open calibration switch

When the open-circuit calibration in the user calibration is turned off, the user-calibrated open-circuit calibration during the measurement process will be calculated using the default data of the STB8851 (the user accessory calibration is not turned on). Only the open circuit data of the calibration point is used.

Set the switch state of user open circuit calibration according to the following steps:

1. Click the **Open** button in the user calibration menu to enter the open circuit calibration menu;
2. Select and click the **ON** or **OFF** button in the Open Calibration menu to set the open state of Open Calibration.

3.2.2.2 All frequency clear for open circuit calibration

All frequency open-circuit calibration is to perform all frequency open-circuit calibration again. After completion, the user's open-circuit calibration will automatically switch to the open state. The zero-clearing data will record and overwrite the original all frequency open-circuit calibration data. If necessary, please pay attention to backup and save the original data.

Perform open-circuit all frequency clear according to the following steps:

1. Click the **Open** button in the user calibration menu to enter the open circuit calibration menu;
2. Connect the user's open-circuit standard test piece to the measuring accessory;
3. Click **All frequency clear** to start clearing, and wait for the clearing to complete. During this process, press **ESC** on the front panel to interrupt the operation.

3.2.2.3 List frequency clear for open circuit calibration

List frequency clear is to perform a one-time open-circuit calibration of the calibration points whose status is open in the current calibration point list, and the calibration results will be recorded and automatically written into the calibration point list. If no calibration point is currently open, it will simply end.

Perform open-circuit list frequency clear according to the following steps:

1. Click the **Open** button in the user calibration menu to enter the open circuit calibration menu;

2. Connect the user's open-circuit standard test piece to the measuring accessory;
3. Click the **List frequency clear** to start clearing, and wait for the clearing to complete.

3.2.3 User short calibration

3.2.3.1 Toggle short calibration switch

When the short-circuit calibration in the user calibration is turned off, the short-circuit calibration of the user-calibration in the measurement process will be calculated using the default data of the STB8851 (the user accessory calibration is not turned on). After the short-circuit calibration is turned on, the user's all frequency short calibration data and the short-circuit data for the calibration point is only used.

Set the switch state of user short-circuit calibration according to the following steps:

1. Click the **Short** button in the user calibration menu to enter the short-circuit calibration menu;
2. Select and click the **ON** or **OFF** button in the Short Calibration menu to set the on-state of the Short Calibration.

3.2.3.2 All frequency clear for short circuit calibration

All frequency clear is to perform all frequency short circuit calibration again. After the user short circuit calibration is completed, it will automatically switch to the open state. The zero-clearing data will record and overwrite the original all frequency short circuit calibration data. If necessary, please pay attention to backup and save the original data.

Perform short-circuit all frequency clear according to the following steps:

1. Click the **Short** button in the user calibration menu to enter the short-circuit calibration menu;
2. Connect the user's short-circuit standard test piece to the measuring accessory;
3. Click **All frequency clear** to start clearing, and wait for the clearing to complete. During this process, press **ESC** on the front panel to interrupt the operation.

3.2.3.3 List frequency clear for short circuit calibration

List frequency clear is to perform a one-time short-circuit calibration of the calibration points whose status is open in the current calibration point list, and the calibration results will be recorded and automatically written into the calibration point list. If no calibration point is currently open, it will simply end.

Perform short-circuit list frequency clear according to the following steps:

1. Click the **Short** button in the user calibration menu to enter the short-circuit calibration menu;
2. Connect the user's short-circuit standard test piece to the measuring accessory;
3. Click the **List frequency clear** to start clearing, and wait for the clearing to complete.

3.2.4 User load calibration

3.2.4.1 Toggle load calibration switch

When the load calibration in the user calibration is turned off, the user-calibrated load calibration during the measurement process will be skipped. After the load calibration is turned on, the user's all frequency load calibration data and the user's calibration point load data will be used.

Set the switch state of user load calibration according to the following steps:

1. Click **Load** button in the user calibration menu to enter the load calibration menu;
2. Select and click the **ON** or **OFF** button in the Load Calibration menu to set the Load Calibration on state.

3.2.4.2 All frequency load calibration

All frequency clear is to re-calibrate the all frequency load. After completion, the user load calibration will automatically switch to the open state, and the calibration data will be recorded and overwritten with the original all frequency load calibration data. If necessary, please pay attention to backup and save the original data. For all frequency load calibration, please use the components of the following model and install them on the measurement fixture:

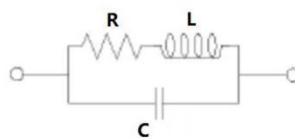

Perform load circuit all frequency clear according to the following steps:

1. Click **Load** button in the user calibration menu to enter the load calibration menu;
2. It is recommended to use a stable resistor or capacitor, the size of which is similar to the size of the DUT, and the impedance value is known and similar to the DUT;
3. Set the value of load resistance, load inductor and load capacitance on the load calibration menu ;
4. Click **All frequency load** to calibrate and wait for the calibration to complete. During this process, press **ESC** on the front panel to interrupt the operation.

3.2.4.3 List frequency load

List frequency load is to perform a one-time load calibration on the calibration point in the current calibration point list whose status is open, and the calibration result will be recorded and automatically written into the calibration point list. If no calibration point is currently open, it will simply end.

Perform the list frequency load as follows:

1. Click **Load** button in the user calibration menu to enter the load calibration menu;
2. Click the **List frequency load** to start the calibration and wait for the calibration to complete.

3.2.4.4 Load parameter setting

1. Click **Load** button in the user calibration menu to enter the load parameter menu;
2. Click the button corresponding to the desired load parameter combination.

3.2.5 Phase calibration

The phase calibration data is related to the measurement accessory, and when the measurement accessory is set, the phase calibration is turned off. After resetting the measurement accessory, if you need to turn on the phase calibration, it is recommended to perform the all frequency phase calibration again. In the **Phase Cal** button of the user calibration menu, the current phase calibration switch status and the date of the current all frequency phase calibration data will be displayed.

3.2.5.1 Toggle phase calibration switch state

When user phase calibration is turned off, the phase calibration during measurement will use the system phase calibration data. If you need to use user phase calibration data, turn phase calibration on.

Switch the user phase calibration state according to the following steps:

1. Click **Phase Cal** button in the user calibration menu to enter the phase parameter menu;
2. Click the **Phase Cal State** to switch the phase calibration switch state.

3.2.5.2 All frequency phase calibration

All-frequency phase calibration is to perform all-frequency phase calibration again. After completion, the user phase calibration will automatically switch to the open state, and the calibration data will be recorded and overwritten with the original user phase calibration data. If necessary, please pay attention to backup and save the original data.

Perform all frequency phase calibration as follows:

1. Click **Phase Cal** button in the user calibration menu to enter the phase parameter menu;
2. Connect the user's open-circuit standard test piece to the measuring accessory;
3. Click **All Frequency Phase Calibration** to start the calibration, wait for the calibration to complete, press **ESC** on the front panel during this process to interrupt the operation.

3.2.6 Accessory Calibration

Accessory calibration can be used to calibrate user-defined measurement accessories, which include open calibration, short calibration, and phase calibration. If the measurement outcome selected by the user is "0m", when the accessory calibration is turned on, the user-calibrated open calibration, short calibration, load calibration, and phase calibration will be automatically turned off (accessory calibration will also be automatically turned off when the above calibration switches are turned on).

Accessory Cal button in the user calibration menu will display the name of the currently selected accessory and the state of the accessory calibration switch.

3.2.6.1 Toggle Accessory Calibration Switch Status

1. Click the **Accessory Cal** button in the user calibration menu to enter the accessory calibration menu;
2. Select the accessory to be loaded and click its corresponding button to select it;
3. Click the **Accessory Cal State** button to switch the accessory calibration switch state.

Note: The name of the accessory button with the * symbol indicates that the accessory currently has a calibration file. Clicking the button will automatically load the file (if there is an error in the file, it will prompt and cancel the loading). Only when the selected accessory has a corresponding calibration file and accessory calibration can be opened only when it is loaded correctly. If there is no corresponding file or the loading is wrong, please click **Start Accessory Cal** to generate the calibration file.

3.2.6.2 Generate Accessory Calibration File

1. Click the **Accessory Cal** button in the user calibration menu to enter the accessory calibration menu;
2. Select the accessory to be loaded and click its corresponding button to select it;
3. Click **Start Accessory Cal** to enter the accessory calibration interface, follow the prompts to complete the calibration process and generate a calibration file.

Note: After completing the above steps, the calibration file corresponding to the accessory selected in step 2 will be overwritten. If necessary, make a backup in advance.

3.3 User calibration point settings

3.3.1 Toggle calibration point switch state

1. Click the calibration point to be modified in the list to enter the calibration point setting menu;
2. Click the **Switch** button to switch the ON/OFF state of the calibration point. Only when the calibration point is on, the calibration data of the calibration point will take effect during measurement.

3.3.2 Set the frequency of the calibration point

1. Click the calibration point to be modified in the list to enter the calibration point setting menu;
2. Click the Measurement **Frequency** button and enter the frequency of the calibration point.

Note: During the measurement process, the STB8851 will search for the frequencies of all open calibration points. When the searched frequency is consistent with the current measurement frequency, the measurement data of this calibration point will be used in the user calibration process.

3.3.3 Set the load reference for the calibration point

1. Click the calibration point to be modified in the list to enter the calibration point setting menu;
2. Click the Ref button and enter the reference value. Only when the reference values in both Ref buttons are set, the set value will be written to the measuring point list and recorded.

Note: The parameters corresponding to the reference values need to be set in the **Load** parameters in the user calibration menu.

3.3.4 Open clear of calibration point

1. Click the calibration point to be modified in the list to enter the calibration point setting menu;
2. Connect the user's open-circuit standard test piece to the measuring accessory;
3. Click the **Open Clear** to complete the open clear of the calibration point, and write the calculation result into the calibration point list and record it.

Note: Only when the user open calibration is turned on, the calibration point is turned on, and the frequency of the calibration point is the current measurement frequency, the open clear data of this point will be called during the measurement.

3.3.5 Short clear of calibration point

1. Click the calibration point to be modified in the list to enter the calibration point setting menu;
2. Connect the user's short-circuit standard test piece to the measuring accessory;
3. Click the **Short Clear** to complete the short clear of the calibration point, and write the calculation result into the calibration point list and record it.

Note: Only when the user short-circuit calibration is turned on, the calibration point is turned on, and the frequency of the calibration point is the current measurement frequency, the short clear data of this point will be called during the measurement.

3.3.6 Load calibration at calibration point

1. Click the calibration point to be modified in the list to enter the calibration point setting menu;
2. Connect the user's standard test piece to the measuring accessory;
3. Click **Load Cal** to complete the load calibration of the calibration point, and write the calculation result to the calibration point list and record it.

Note: Only when the user load calibration is turned on, the calibration point is turned on, and the calibration point frequency is the current measurement frequency, the load calibration data of this point will be called in the measurement.

Chapter 4 Point Measurement

This section describes operations to set the measurement conditions in the point measurement mode, such as frequency, average count, etc.

Press **Preset** button on the front panel first to restore the instrument to the factory setting, and then confirm the complete status recovery.

4.1 Channel

The point measurement interface of STB8851 displays eight channels, and every channel can set different measurement conditions and parameters. During the measurement process, different parameters can be set in different channels to complete different measurement requirements. Click the channel buttons on the left side of the interface to switch channel.

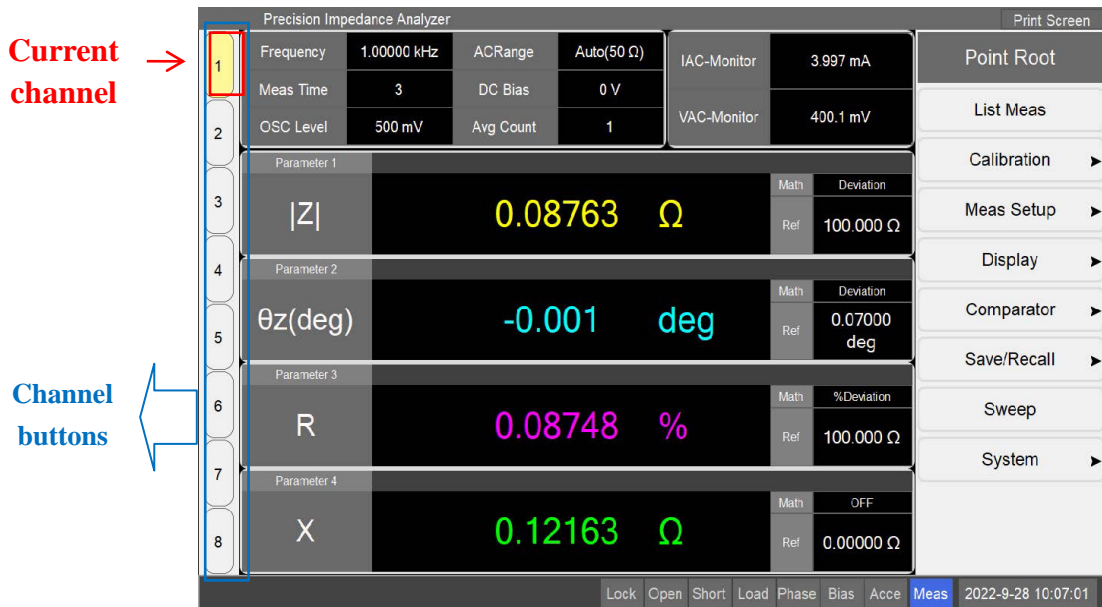

4.2 Frequency

Operation steps below for setting the measurement frequency:

1. Two ways to set **Frequency**: one is to click **Frequency** on the screen, and another is to click **Meas Setup** on **Point Root** menu and then click **Frequency**.
2. Enter the frequency to be modified, for example, enter 1kHz, press 1 and k/m at the front panel in turn, the measurement frequency will be changed to 1kHz.
3. The frequency can also be adjusted by using the up and down arrows and scroll wheel on the front panel.

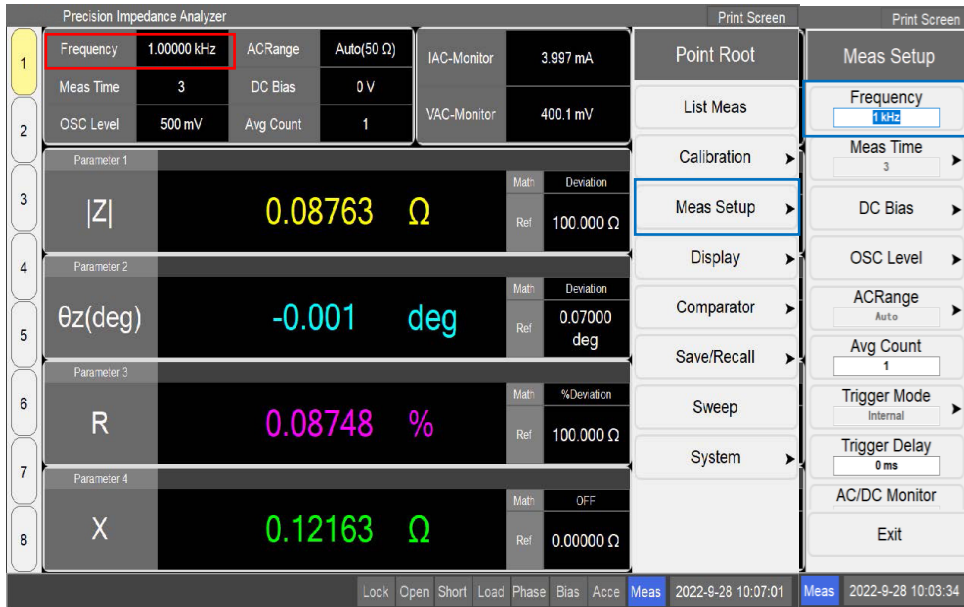

4.3 Meas Time

Operation steps below for setting the measurement rate:

1. Two ways to set **Meas Time**: one is to click **Meas Time** on the screen to enter **Meas Time** menu, and another is to click **Meas Setup** on **Point Root** menu and then click **Meas Time** to enter **Meas Time** menu.
2. Select needed number level on **Meas Time** menu.
3. Generally, the slower the measurement rate, the more accurate the measurement.

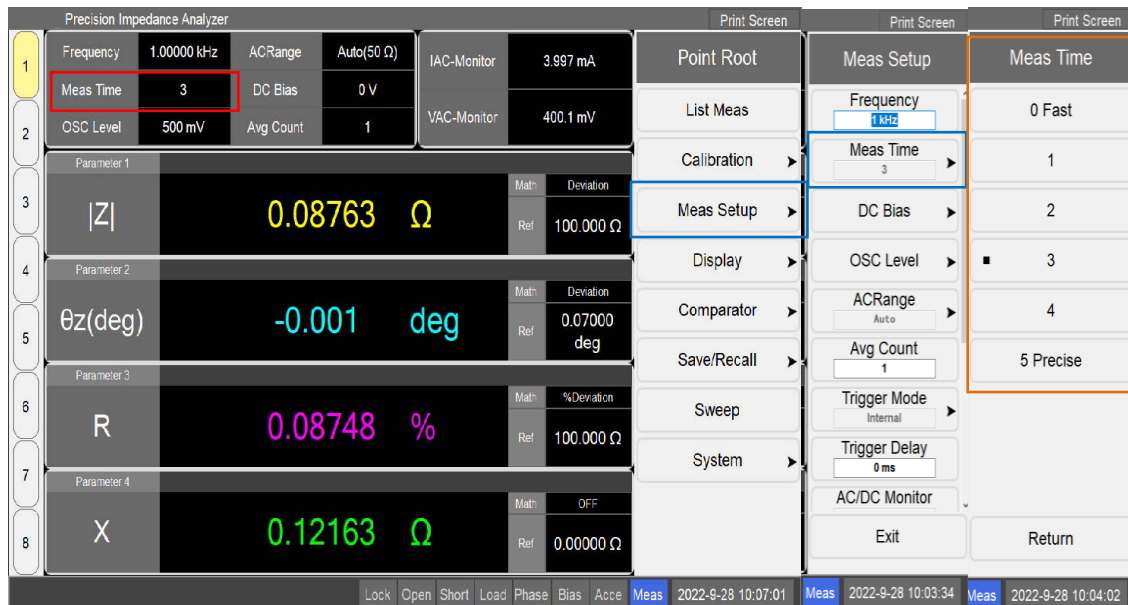

4.4 Avg Count

Operation steps below for setting the measurement average:

1. Two ways to set **Avg Count**: one is to click **Avg Count** on the screen, and another is to click **Meas Setup** on **Point Root** menu and then click **Avg Count**.
2. Enter the average count to be modified, for example, enter 1, and press the 1 and x1 buttons in sequence at the front panel to modify the average count to 1.
3. The average count can also be adjusted by using the up and down arrows and scroll wheel on the front panel.

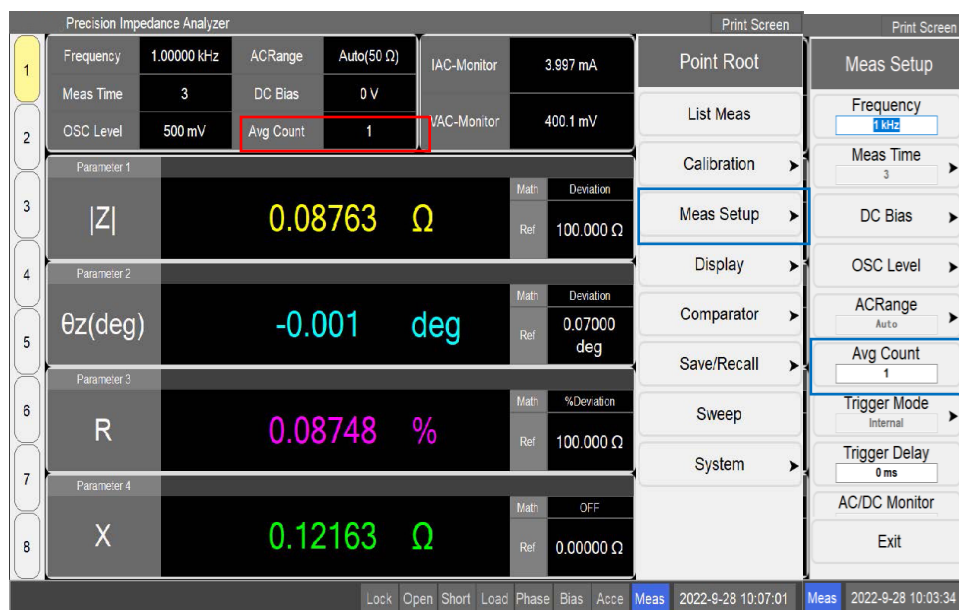

4.5 OSC Level

Operation steps below for setting the measurement level:

1. Two ways to set **OSC Level**: one is to click **OSC Level** on the screen, and another is to click **Meas Setup** on **Point Root** menu and then click **OSC Level** enter **OSC Level** menu.
2. The source mode (**OSC Unit**) can be voltage or current, switched on **OSC Level** menu. The way to modify level value is to click **Voltage Level** or **Current Level** and set the needed voltage or current value. When the source mode is switched, the corresponding value will be automatically applied and displayed on Point Root interface.
3. Two operations to modify level value on the front panel: one is to press the digital buttons, and another is to press the directional buttons and turn the knob.

NOTE: When source internal resistance (**Internal Resistance**) is 100Ω, **Voltage Level** range is 5mV-2V, and **Current Level** range is 50μA-20mA. It is worth noting that **Voltage Level** can be greater than 1V, and **Current Level** can be greater than 10mA, only when Frequency isn't higher than 1MHz. But when Frequency is higher than 1MHz, the source level will be automatically adjusted to the maximum allowable value.

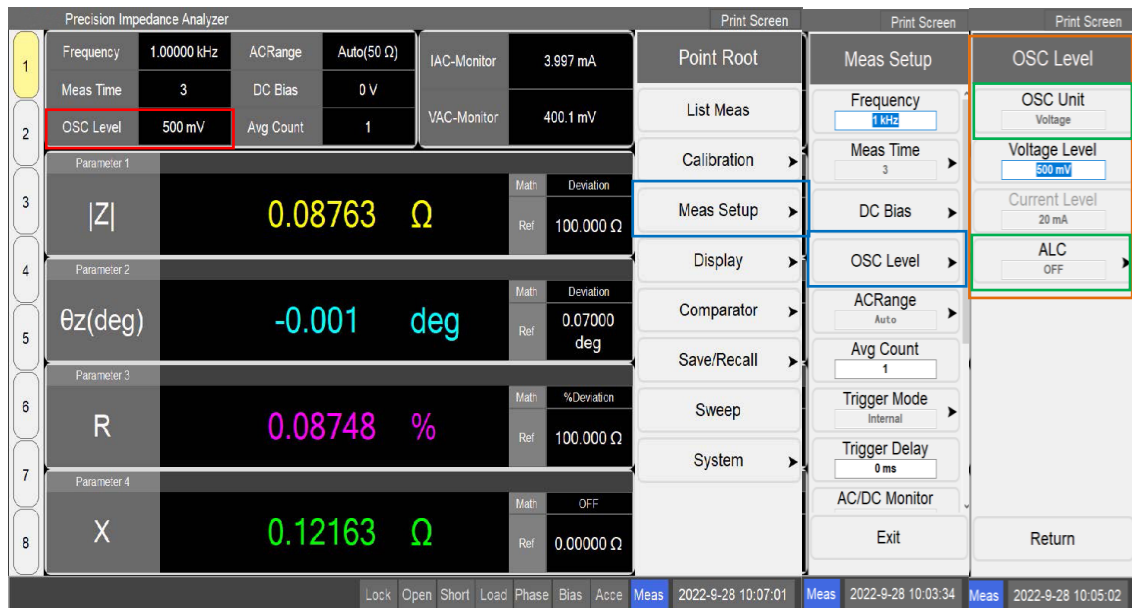

Operation steps below to set **ALC**

- Click **ALC** on **OSC** menu to enter **ALC** menu.
- Click **ALC Control** to switch ALC state.
- Click **Max Iteration** to input the needed iteration value whose range is 2-10.
- Click **Target %** to input the needed accuracy whose range is 0.05-10.

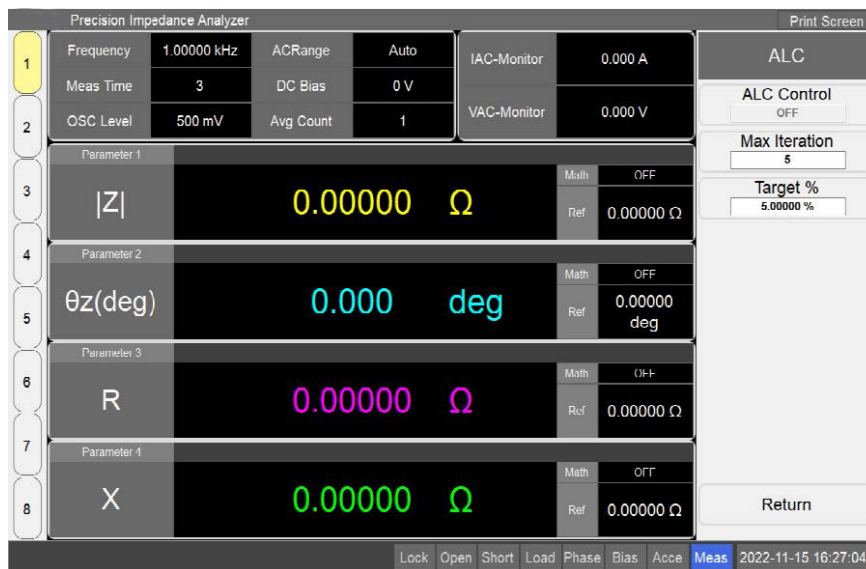

4.6 DC Bias

Operation steps below for setting the DC bias:

1. Two ways to set **DC Bias**: one is to click **DC Bias** on the screen to enter **DC Bias** menu, and another is to click **Meas Setup** on **Point Root** menu and then click **DC Bias** enter **DC Bias** menu.

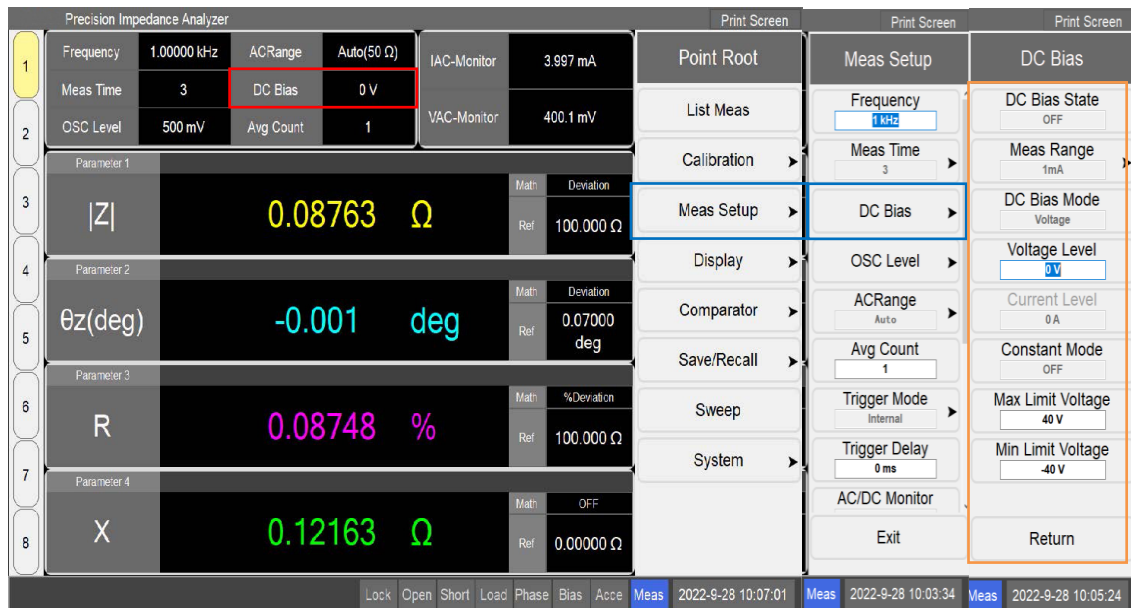

2. Operation steps below to set the corresponding parameters:
 - Click **DC Bias State** on **DC Bias** menu or press **DC Bias** button on the front panel to switch state.
 - Click **Meas Range** on **DC Bias** menu to select the needed range.
 - Click **DC Bias Mode** on **DC Bias** menu to switch mode that is **Voltage** or **Current**. If bias mode is **Voltage**, click **Voltage Level** to modify level value, else click **Current Level**. When the bias mode is switched, the corresponding value will be automatically applied and displayed on Point Root interface.
 - Click **Constant Mode** on **DC Bias** menu to switch constant voltage state.
 - Click **Max/Min Limit Voltage** on **DC Bias** menu to set max/min voltage value.
3. Two operations to modify the level value or max/min voltage value of constant voltage on the front panel: one is to press the digital buttons, and another is to press the directional buttons and turn the knob.

NOTE: The measurement range (**Meas Range**) and bias voltage (**Voltage Level**)/current (**Current Level**) will apply to the measurement only when the bias state (**DC Bias State**) is on. If the bias state is off, the measurement range is the default 1mA, and the bias voltage/current is 0.

4.7 AC Range

Operation steps below for setting the AC range:

1. Two ways to set **ACRange**: one is to click **ACRange** on the screen to enter **ACRange** menu, and another is to click **Meas Setup** on **Point Root** menu and then click **ACRange** enter **ACRange** menu.
2. On **ACRange** menu, if range is set to automatic, the automatic range judgment is made during the measurement, and the true range will display in the AC range area. Else select needed range value.

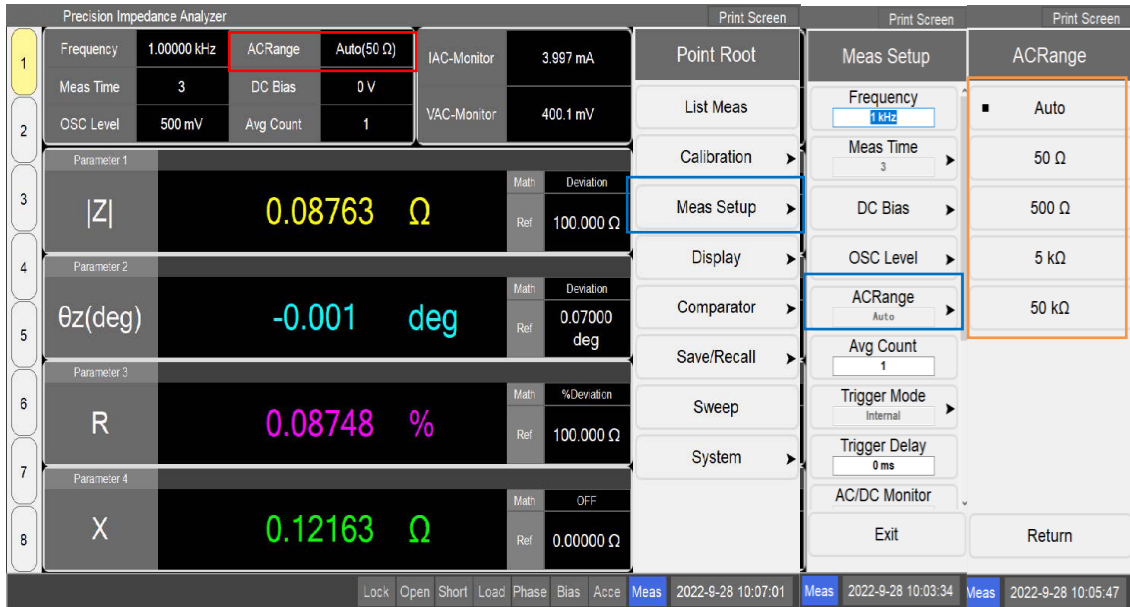

4.8 Trigger

4.8.1 Trigger Mode

Operation steps below for setting the trigger mode:

- Two ways to select **Trigger Mode**: one is to press **Trigger Mode** button on the front panel to enter **Trigger Mode** menu, and another is to click **Meas Setup** on **Point Root** menu and then click **Trigger Mode** enter **Trigger Mode** menu.
- There are four trigger modes below to select.

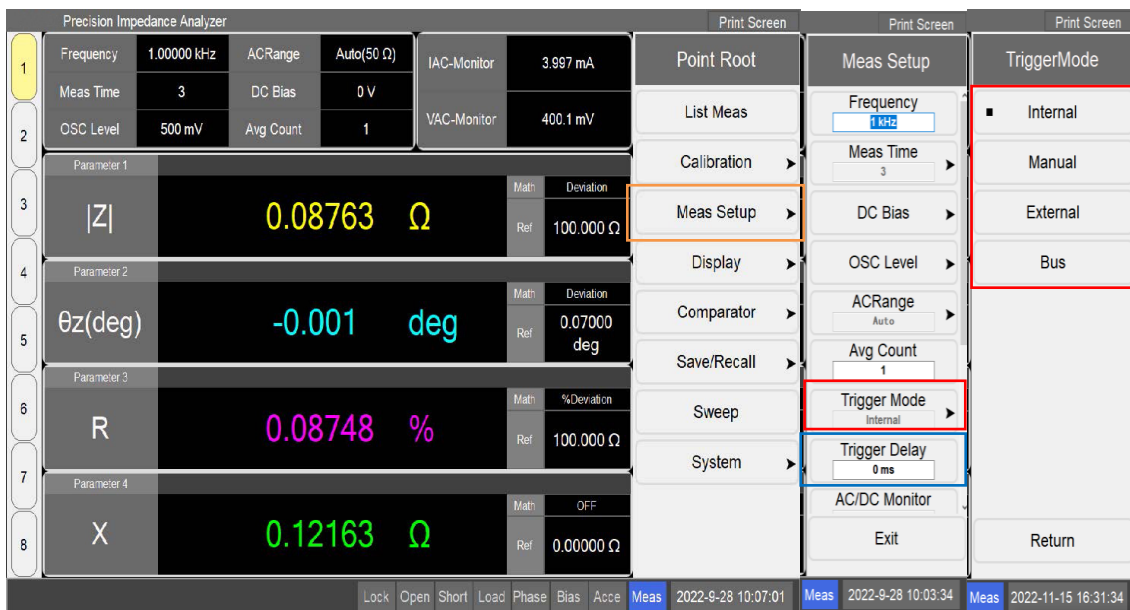

Trigger Source	Function
Internal	Use a consecutive signal generated by the firmware as a trigger source. Triggers are sent immediately following the completion of each measurement.
External	Use the external trigger input terminal (Handler) as a trigger source.
Manual	Press Trigger to make a trigger.
Bus	A trigger is generated through GPIB/LAN/USB.

4.8.2 Trigger Delay

Operation steps below for setting the trigger delay:

1. One way to select **Trigger Delay** is to click **Meas Setup** on **Point Root** menu and then click **Trigger Delay**.
2. Two operations to modify delay time value on the front panel: one is to press the digital buttons, and another is to press the directional buttons and turn the knob.

4.9 Result

4.9.1 Parameter

In a point measurement, the screen can display up to 4 parameters at same time.

Operation steps below for setting the measurement parameters:

1. Two ways to select measurement parameters: one is to click **Parameter1~4** to enter **Display** menu, and another is to click **Display** on **Point Root** menu and then click **Parameter1~4** to enter corresponding **Parameter** menu.

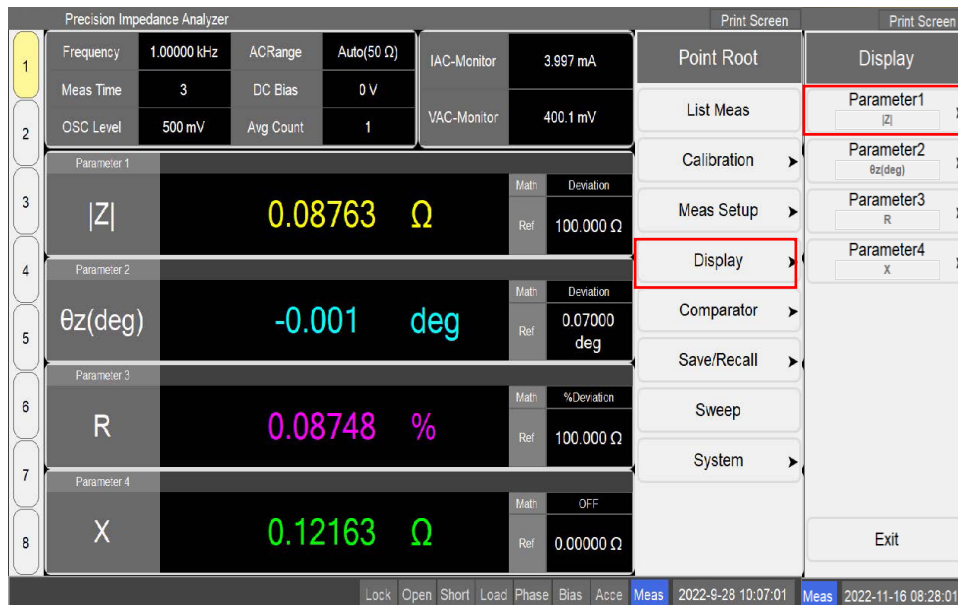

2. There are twenty-four parameters below to select.

Name	Description
$ Z $	Absolute impedance
$ Y $	Absolute admittance
θ_z (rad)	Impedance phase (rad)
θ_y (rad)	Admittance phase (rad)
θ_z (deg)	Impedance phase (deg)
θ_y (deg)	Admittance phase (deg)
R_s	Equivalent series resistance
R_p	Equivalent parallel resistance
L_s	Equivalent series inductance
L_p	Equivalent parallel inductance
C_s	Equivalent series capacitance
C_p	Equivalent parallel capacitance
R	Equivalent series resistance
G	Equivalent parallel conductance
X	Equivalent series reactance
B	Equivalent parallel susceptance
Q	Q value (Quality factor)
D	Dissipation factor
ϵ_r'	Relative permittivity real part (need permittivity module)
ϵ_r''	Relative permittivity imaginary part (need permittivity module)
$ \epsilon_r $	Relative permittivity (need permittivity module)
μ'	Relative troidalcore real part (need troidalcore module)
μ''	Relative troidalcore imaginary part (need troidalcore module)
$\tan \delta$	Phase (need troidalcore module)

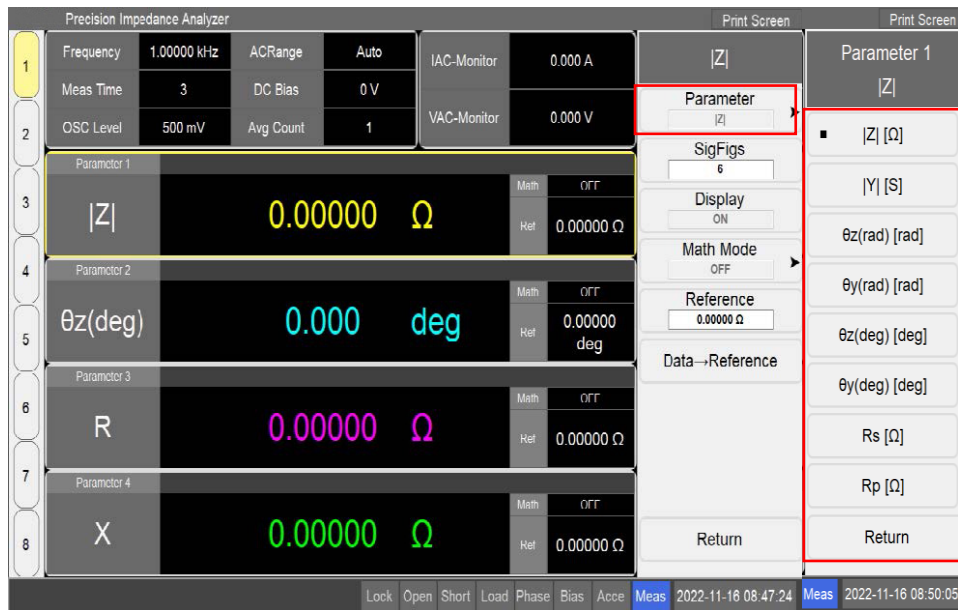

4.9.2 Math Mode

There are three modes below to display measurement results that are Deviation, %Deviation and OFF.

Mode	Description
OFF	Measurement value
Deviation	Measurement value-Reference value
%Deviation	(Measurement value-Reference value) *100%/Reference value

Operation steps below for setting the math mode:

- Two ways to select the math mode of different parameter: one is to click different **Math** to enter corresponding **Parameter** menu, and another is to click **Display** on **Point Root** menu and then click **Parameter1~4** to enter corresponding **Parameter** menu.
- On **Parameter Set** menu, click **Math Mode** to enter **Math** menu and select the needed math mode.

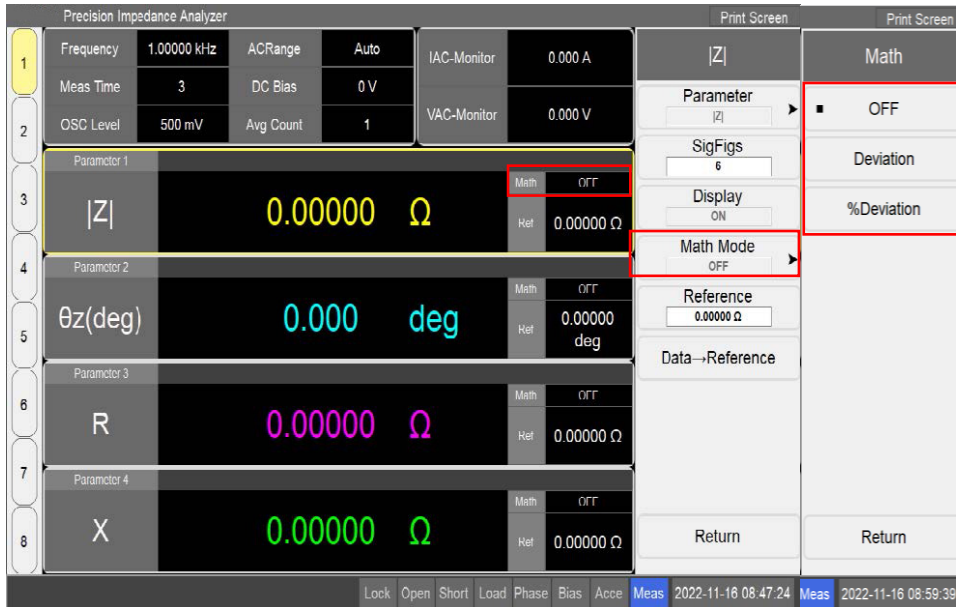

4.9.3 Reference

Operation steps below for setting the reference:

1. Two ways to select the reference of different parameters: one is to click different **Ref** to enter corresponding **Parameter** menu, and another is to click **Display** on **Point Root** menu and then click **Parameter1~4** to enter corresponding **Parameter** menu.
2. On **Parameter** menu, click **Reference** to modify reference value or click **Data→Reference** that means set current measurement result to reference value.
3. Two operations to modify reference value on the front panel: one is to press the digital buttons, and another is to press the directional buttons and turn the knob.

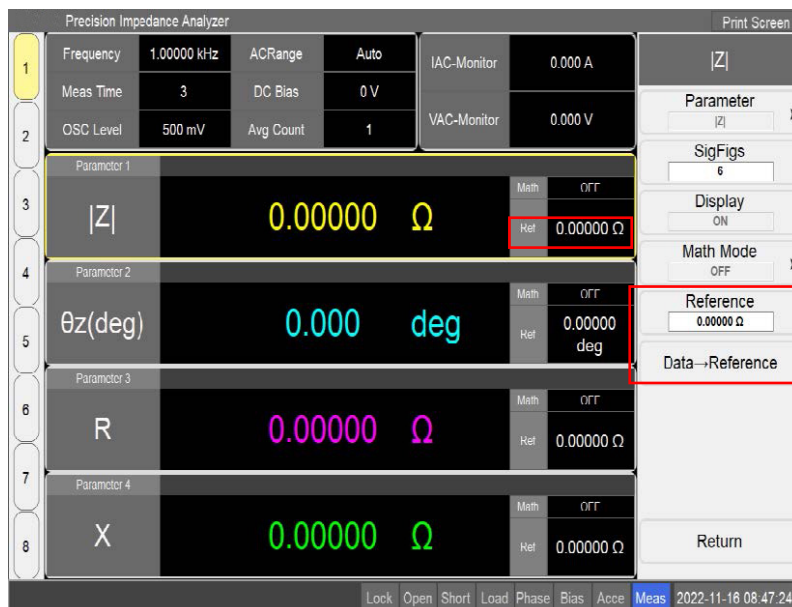

4.10 Comparator

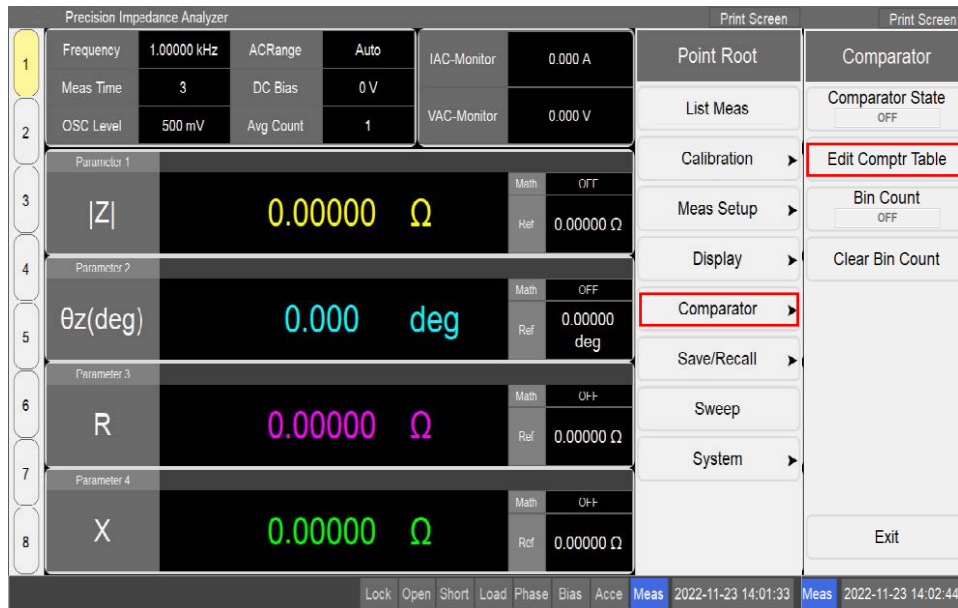

Comparator: this module is used to sort the measurement results.

Click **Comparator** on **Point Root** menu to enter **Comparator** menu, then click **Edit Comptr Table** to enter **Comparator Table** interface.

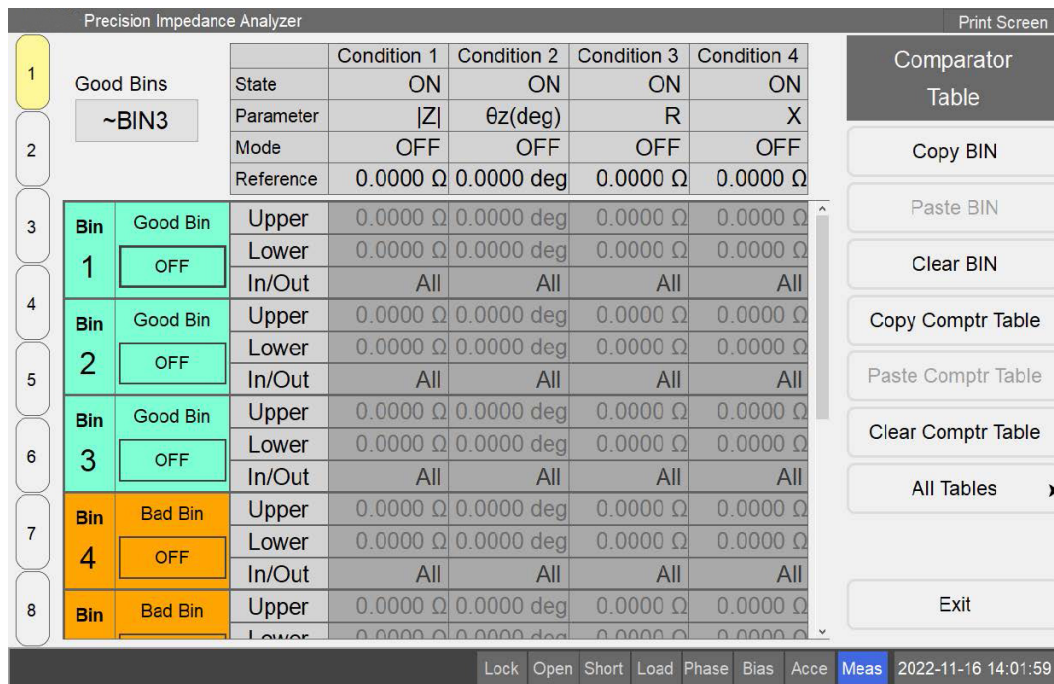

Related features of BIN setting as shown below:

1. The interface can be set up to 9 BINs and 4 conditions for the measurement results. And only when the BIN meets all current conditions, it can be counted as qualified.
2. Each BIN or Condition has own switch.
3. All BINs are sorted from BIN1 to BIN9 to perform sorting calculation.

- There are two modes of BIN, one is Good Bin that means qualified judgment, and another is Bad Bin that means unqualified judgment.
- If the measurement result doesn't belong to any BIN, it will be sorted to NG.

4.10.1 Condition1~4

4.10.1.1 Parameter

Parameter of Condition1~4: they are used to perform the sorting judgment and are independent of point measurement parameters used to display measurement results.

Operation steps below for setting the parameter:

- Click **Parameter** cell to pop up the selection window.
- Select and click the needed parameter.

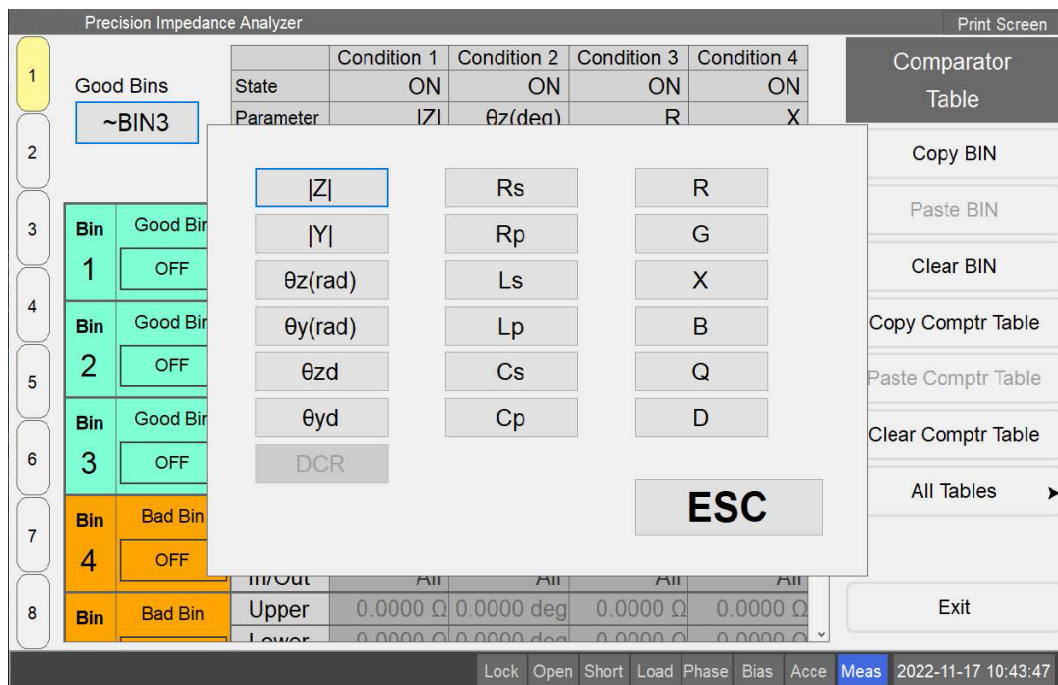

4.10.1.2 Math Mode and Reference

Math Mode of Condition1~4: they are used to select the format of Upper and Lower.

Reference of Condition1~4: set Upper and Lower according to them.

Operation steps below for setting the math mode and reference:

- Click **Mode** cell to pop up the selection window.
- Select and click the needed math mode.
- Click **Reference** cell to set the value.
- Two operations to modify reference value on the front panel: one is to press the digital buttons, and another is to press the directional buttons and turn the knob.

Math Mode	Description
OFF	Upper and Lower of each BIN are absolute values. When this mode is selected, the reference value can not be set.
%	Upper and Lower of each BIN are the difference between the upper/lower limits and the .reference
Deviation	Upper and Lower of each BIN are the percentage of the ratio that is the upper/lower limits to the reference.
%Dev	Upper and Lower of each BIN are the percentage of the ratio that is the difference (between the upper/lower limits and the .reference) to the reference.

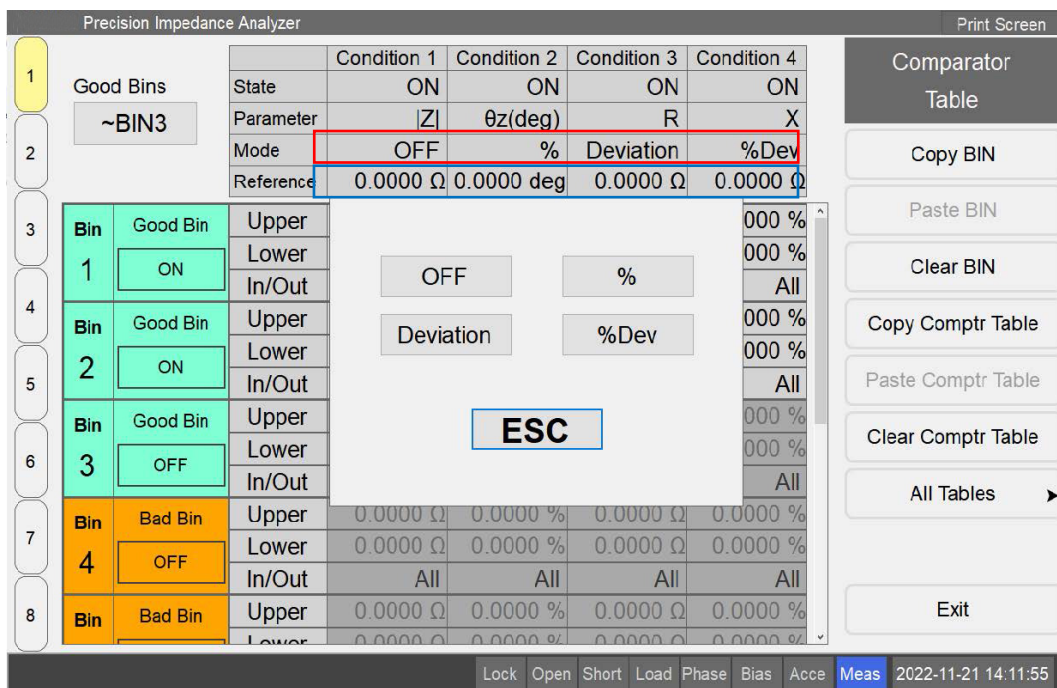

4.10.2 BIN

4.10.2.1 Upper and Lower

Operation steps below for setting the upper and lower limits:

1. Click **Upper** and **Lower** cell to set the value.(BIN state is ON)
2. Two operations to modify limit value on the front panel: one is to press the digital buttons, and another is to press the directional buttons and turn the knob.

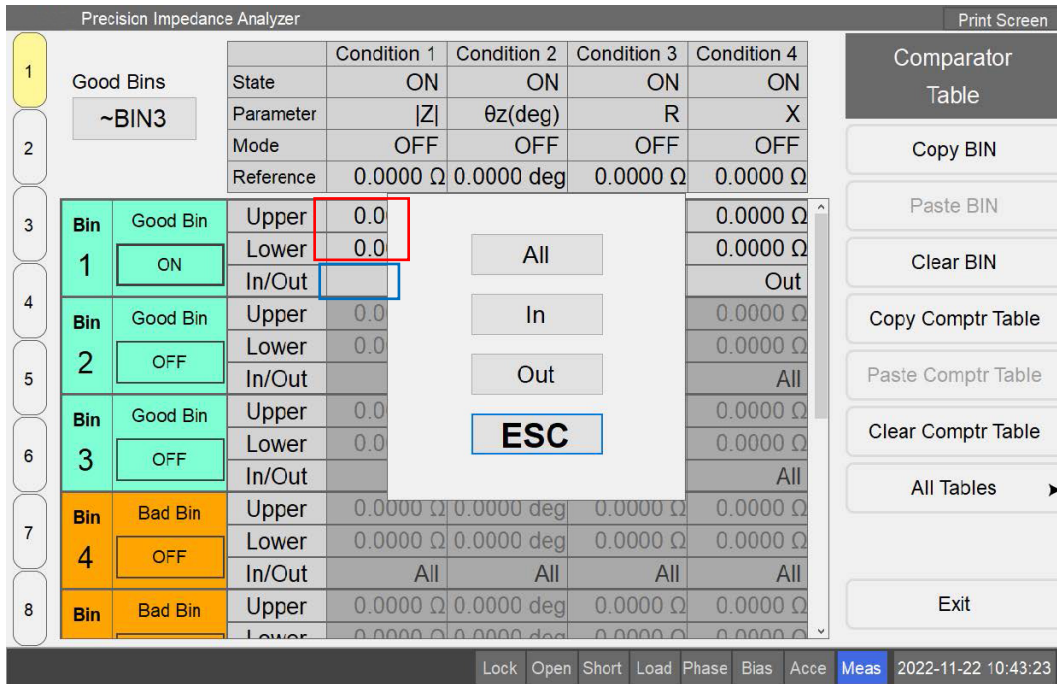

4.10.2.2 In/Out

Operation steps below for setting the acceptable range:

1. Click **In/Out** cell to pop up the selection window as shown above.
2. Select and click the needed mode.

In/Out Mode	Description
All	This mode defines that the qualified range is independent of the upper and lower limits of BIN, that is, no matter what the measurement result is, it is considered as qualified
In	This mode defines that the qualified range is between the upper limit and lower limit of BIN.(greater than the lower limit and less than the upper limit)
Out	This mode defines that the qualified range is outside the upper and lower limits of BIN.(greater than or equal to the upper limit or less than or equal to the lower limit)

4.10.2.3 Copy, Paste and Clear

These operations are only for upper/lower limits and In/Out mode as shown below.

Operation steps below to Copy, Paste and Clear BIN settings:

1. Click **BIN1~9** name cell to check the BIN whose settings need to be copied.
2. Click **Copy BIN** on **Comparator Table** menu on the right to copy.
3. Click **BIN1~9** name cell to check the BIN whose settings need to paste.
4. Click **Paste BIN** on **Comparator Table** menu on the right to paste.
5. Click **BIN1~9** name cell to check the BIN whose settings need to be cleared.

- Click **Clear BIN** on **Comparator Table** menu on the right to clear.

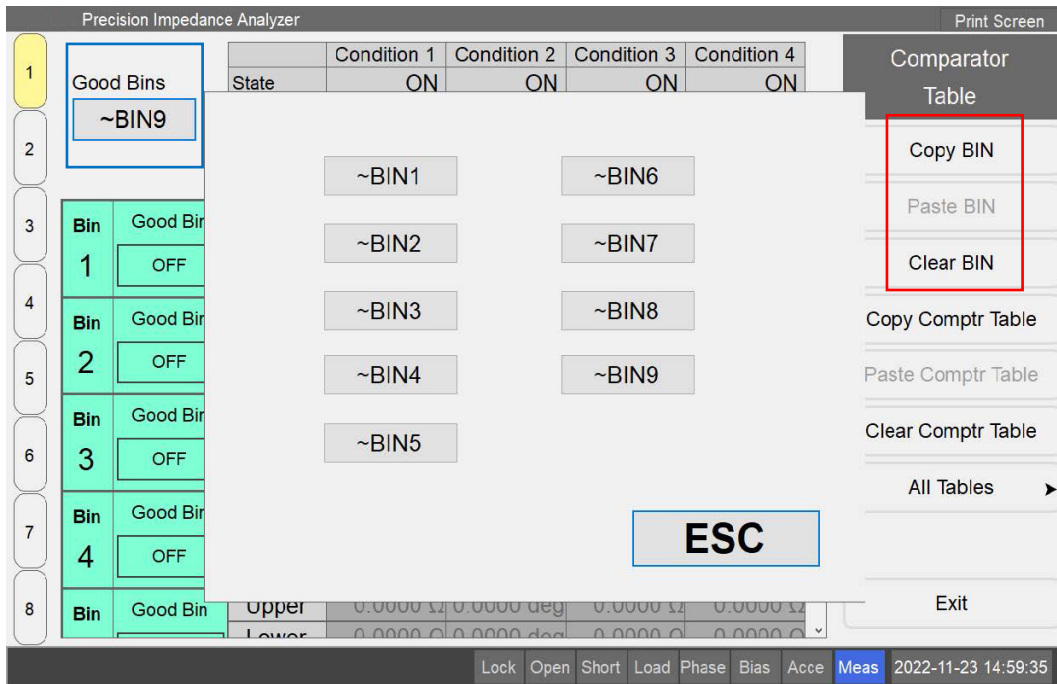

4.10.2.4 Good/Bad Bin

In the upper left corner of **Comparator Table** interface, click **Good Bins** to set the number of good and bad Bins as shown above.

For example, if **Good Bins** is ~BIN3, that means BIN1 to BIN3 are good Bins and BIN4 to BIN9 are bad Bins.

4.10.2.5 Result

Operation steps below for setting the sorting results (when sorting settings complete):

- On **Comparator** menu, click **Comparator State** to made state on to display sorting results on the point measurement interface. If state is OFF, sorting results are hidden.
- On **Comparator** menu, click **BIN Count** to made state on to display the count on the point measurement interface.
- On **Comparator** menu, click **Clear Bin Count** to clear the count on the point measurement interface.

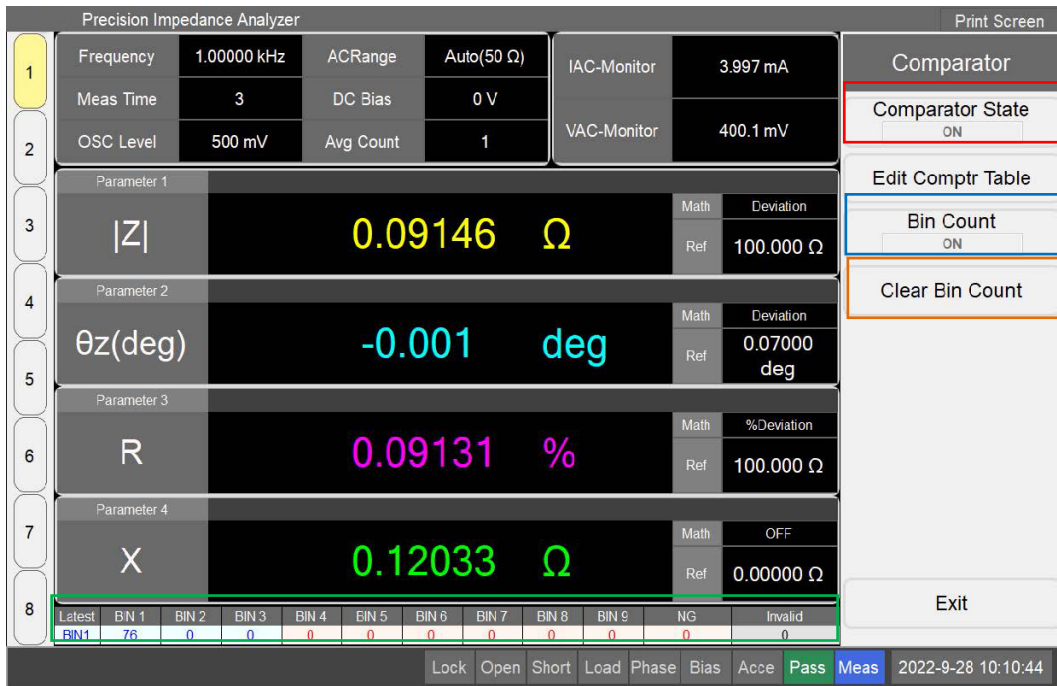

NOTE: Latest in the result column displays the last time sorting result. If the sorting result fails to meet any BIN, Latest displays Out. If the measurement result is Overload, Latest displays Invalid. If the sorting result belongs to the good Bin, Latest displays the blue BIN name. If the sorting result belongs to the bad Bin, Latest displays the red BIN name.

Chapter 5 List Measurement

This section describes operations to set the measurement conditions in the list measurement mode, such as frequency, average count, etc.

Press **Preset** button on the front panel first to restore the instrument to factory setting, and then confirm the complete status recovery.

5.1 Channel

The list interface of STB8851 displays eight channels, and every channel can set different measurement conditions and parameters. During the measurement process, different parameters can be set in different channels to complete different measurement requirements. Toggling channel can be operated by clicking channel buttons on the left side of the screen.

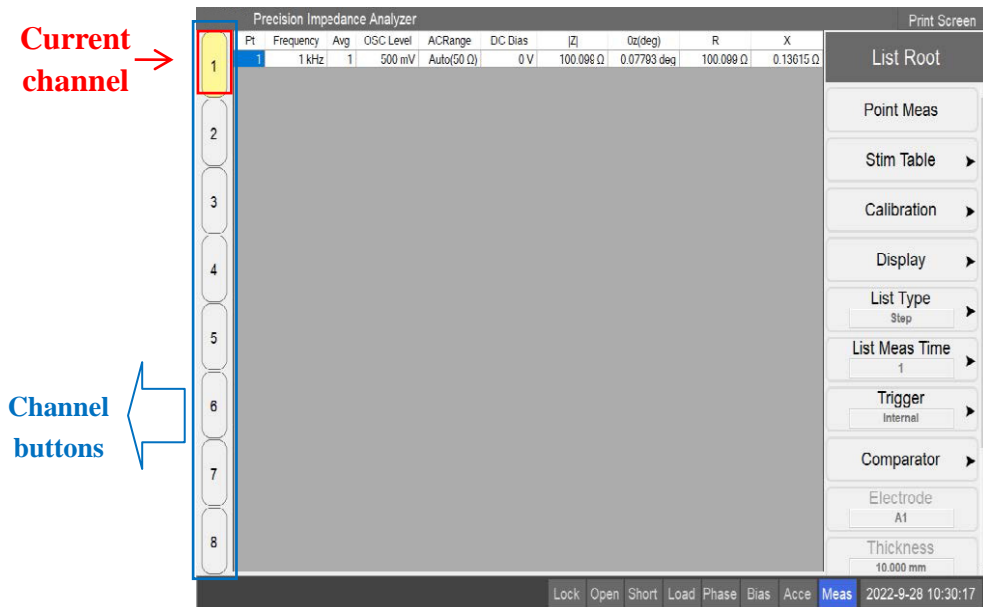

5.2 Measurement Point

Click **List Meas** on **Point Root** menu enter to **List Root** interface.

Click **Stim Table** on **List Root** menu to enter **Stimulus Table** interface.

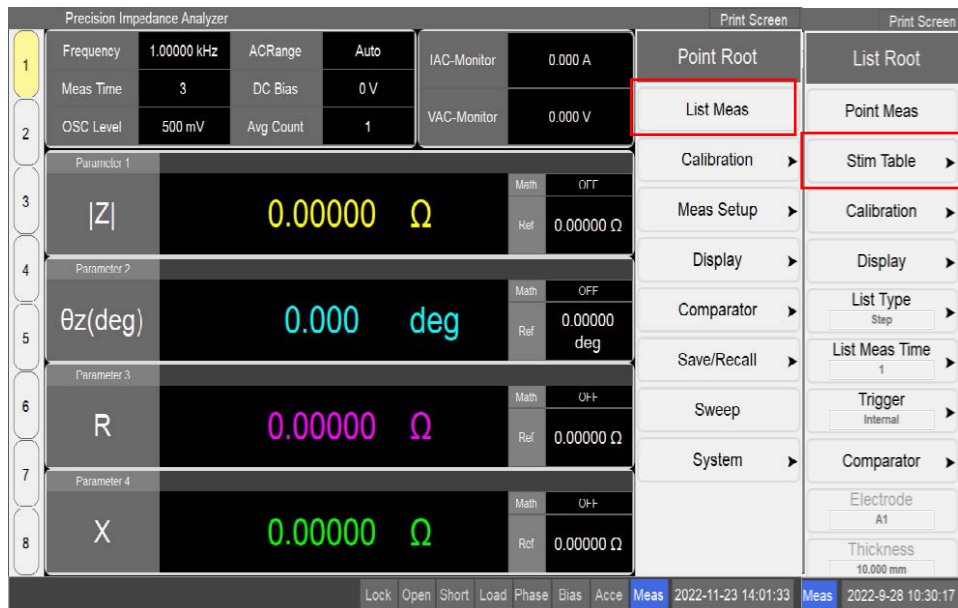

5.2.1 Add Row

In the initial state, each channel has only one measurement point, the frequency is 1kHz, the average is 1, the OSC level is 500mV, and the AC range is automatic.

Operation steps below for add measurement points:

1. One way is to click **Add Row** to add a new row at the bottom, then click **Add Row** button several times to add several rows.

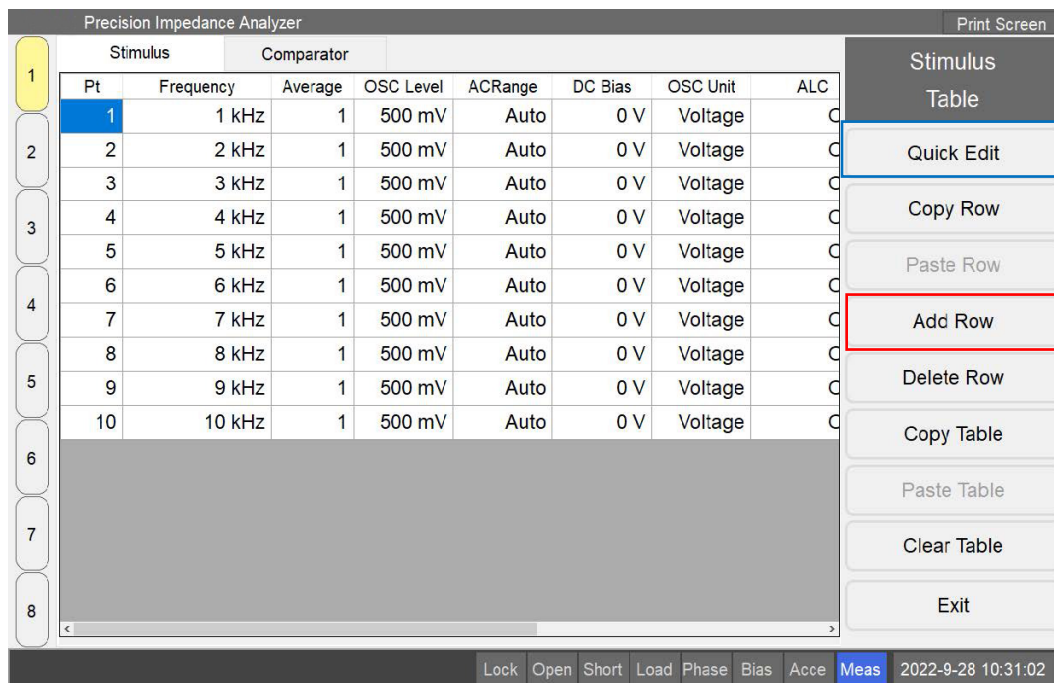

2. Another way is to click Quick Edit on **Stimulus menu** to enter setting interface, then set **Num of Points** to the needed value to add rows.

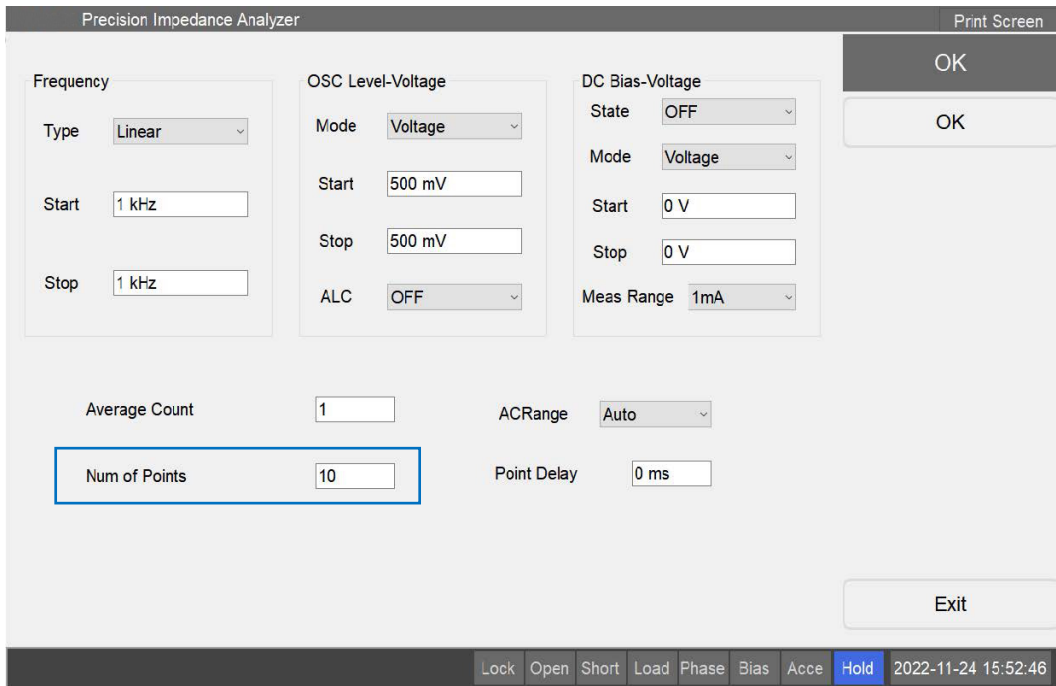

5.2.2 Copy, Paste and Delete Row

Operation steps below for copy, paste and deletes measurement points:

1. Check any cell of a row and then click **Copy Row** on **Stimulus Table** menu.
2. Click **Paste Row** on **Stimulus Table** menu to add the copied row at the bottom.
3. Check any cell of a row and then click **Delete Row** on **Stimulus Table** menu to delete this row.

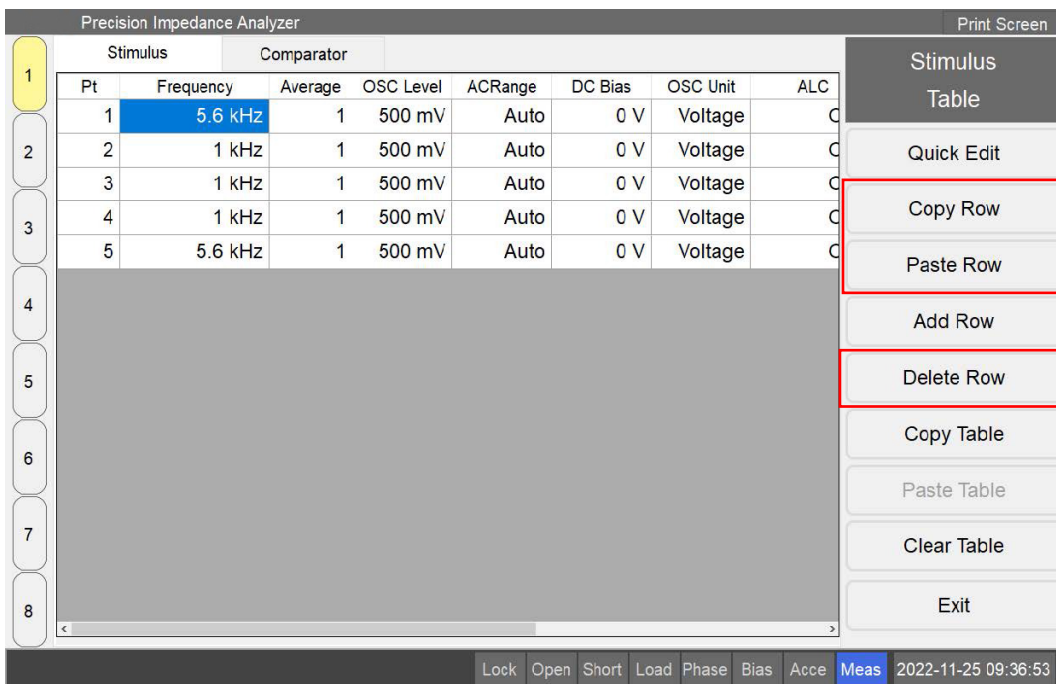

5.2.3 Measurement Settings

5.2.3.1 Frequency

Operation steps below to modify the frequency of measurement points:

1. Click **Frequency** cell that need to modify the value to enter the corresponding point menu.
2. Two operations to modify the value on the front panel: one is to press the digital buttons, and another is to press the directional buttons and turn the knob.

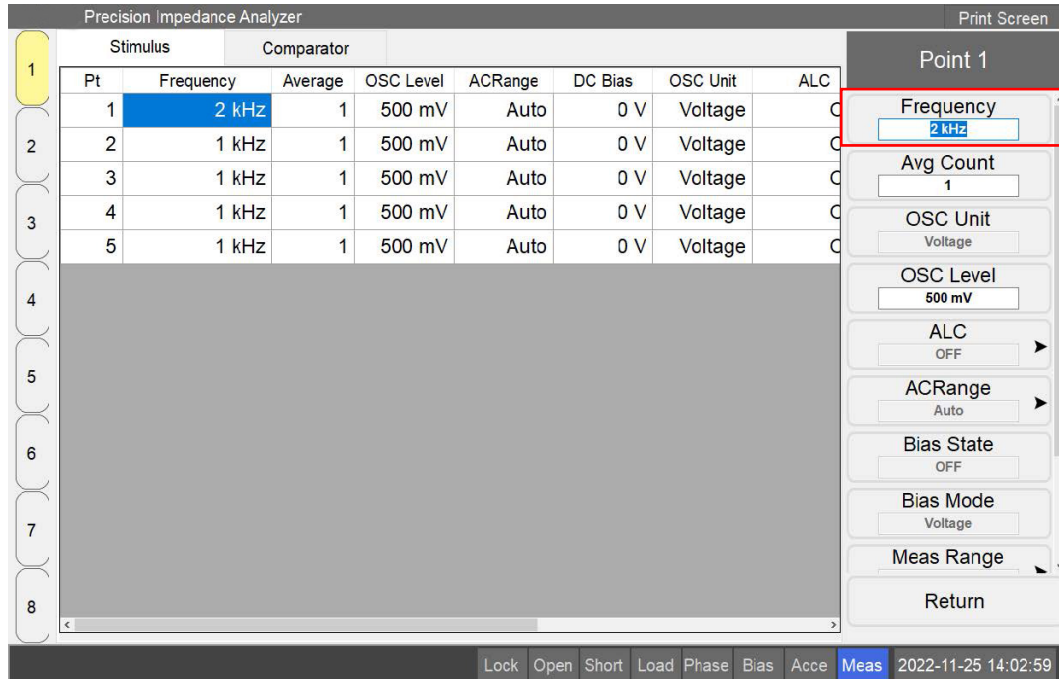

5.2.3.2 Average

Operation steps below to modify the average of measurement points:

1. Click **Average** cell that need to modify the value to enter the corresponding point menu.
2. Two operations to modify the value on the front panel: one is to press the digital buttons, and another is to press the directional buttons and turn the knob.

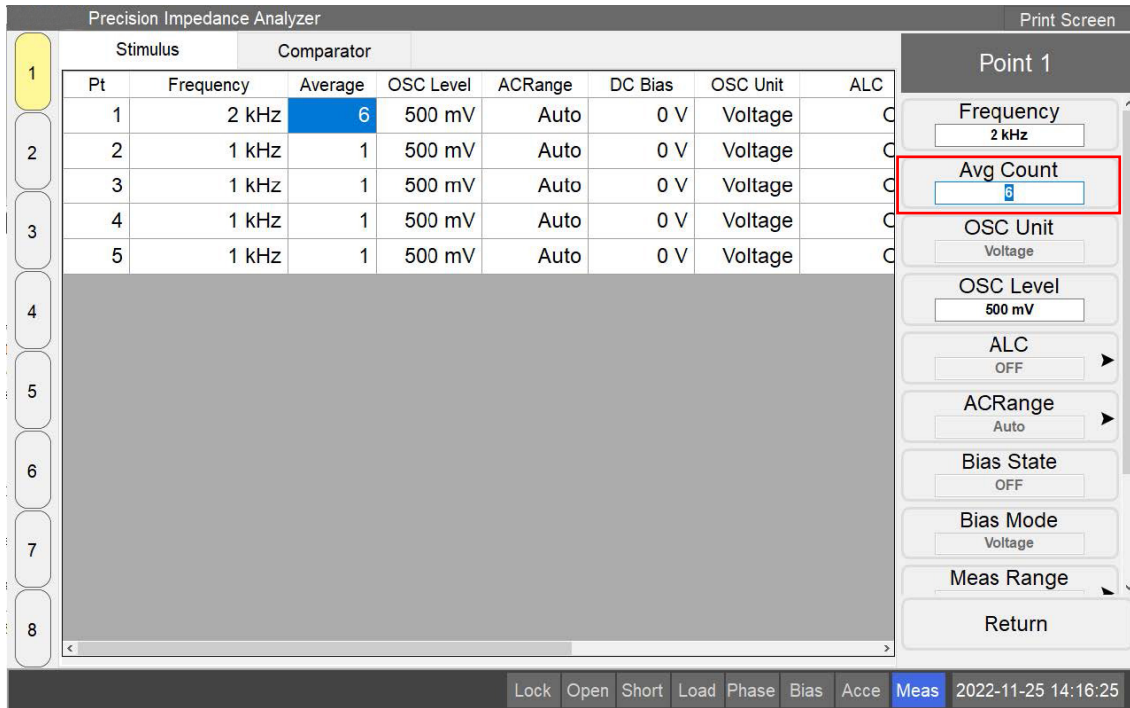

5.2.3.3 OSC Level

Operation steps below to modify the level of measurement points:

1. Click **OSC Level** cell that need to modify the value to enter the corresponding point menu.
2. Two operations to modify the value on the front panel: one is to press the digital buttons, and another is to press the directional buttons and turn the knob.

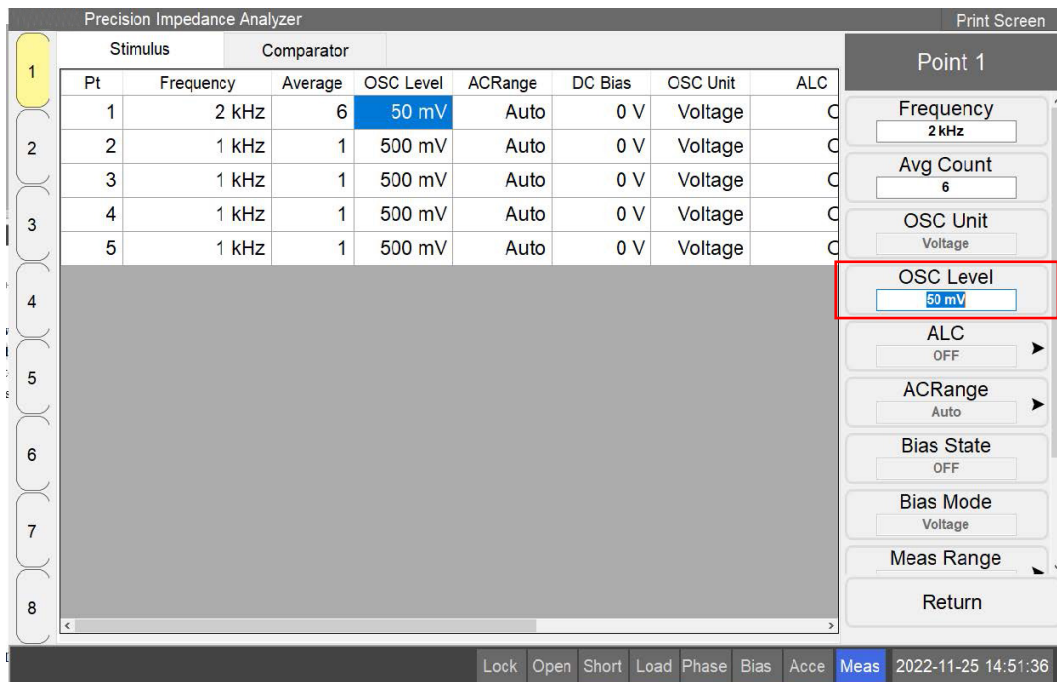

3. The specific setting requirements are the same as those in 4.5.

5.2.3.4 ACRange

Operation steps below to modify the AC range of measurement points:

1. Click **ACRange** cell on the screen to enter **ACRange** menu,.
2. On **ACRange** menu, if range is set to automatic, the automatic range judgment is made during the measurement, and the true range will display in the AC range area. Else select needed range value.

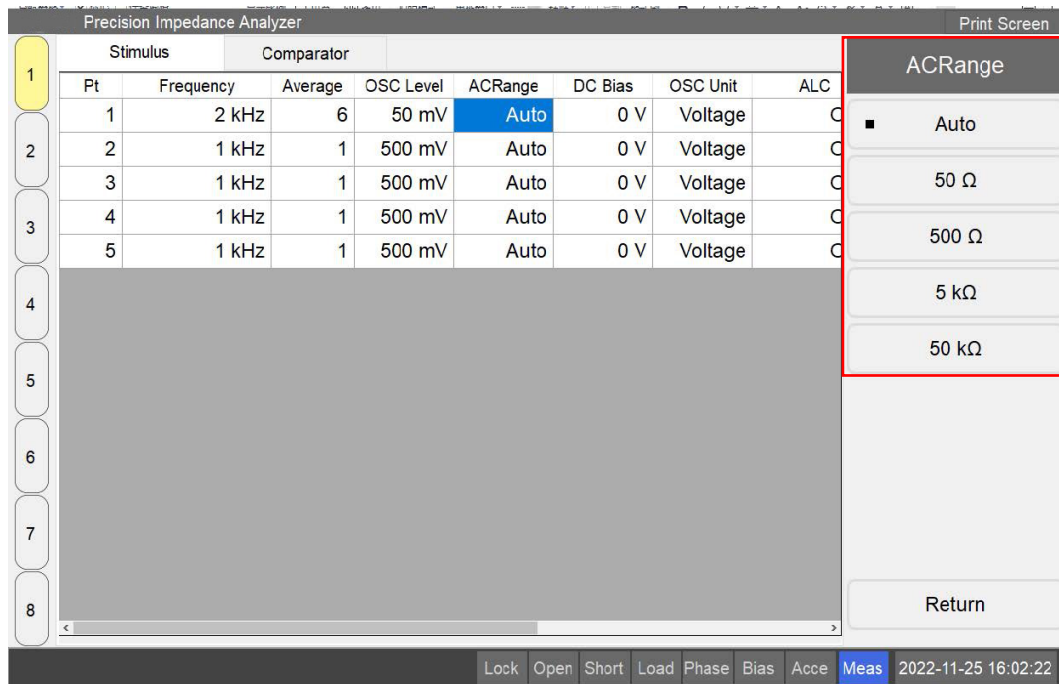

5.2.3.5 DC Bias

Operation steps below to modify the bias level of measurement points:

1. Click **DC Bias** cell that need to modify the value to enter the corresponding point menu.
2. Two operations to modify the value on the front panel: one is to press the digital buttons, and another is to press the directional buttons and turn the knob.

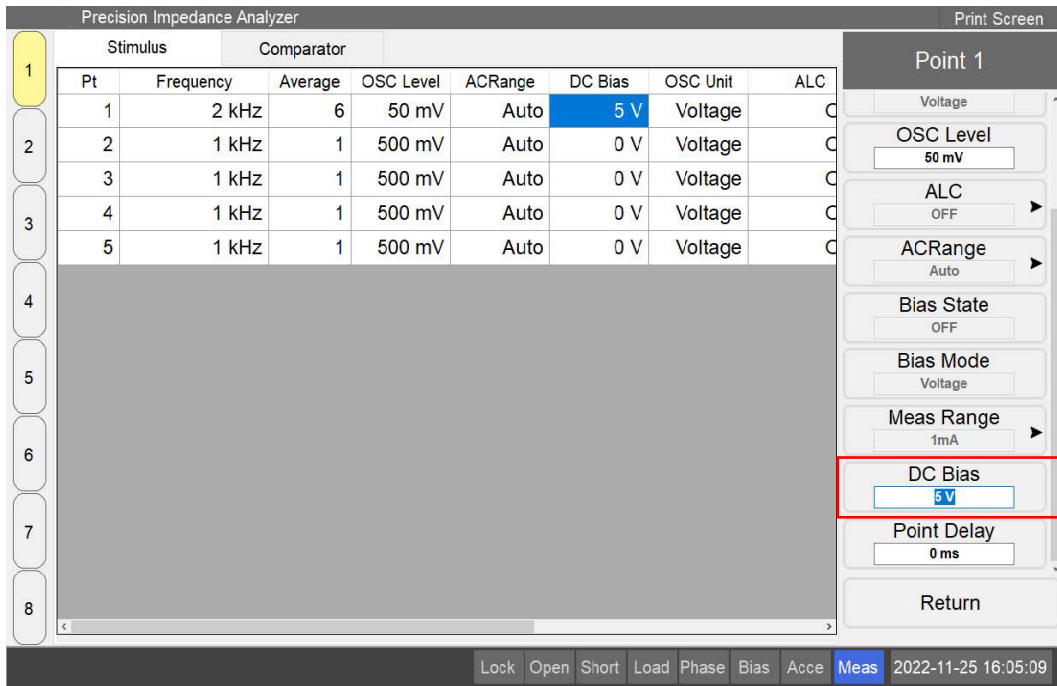

5.2.3.6 List Meas Time

Operation steps below to modify the rate of measurement points:

1. Click **List Meas Time** on **List Root** menu to enter **Meas Time** menu.
2. Select needed number on **Meas Time** menu.

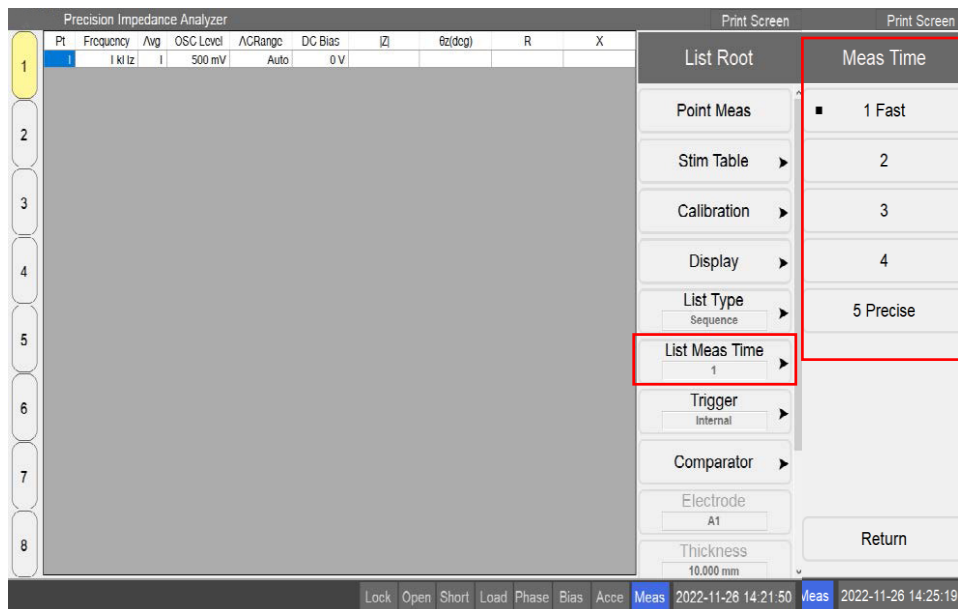

5.3 Trigger

5.3.1 Trigger Mode

Operation steps below to modify trigger mode:

1. Click **Trigger** on **List Root** menu to enter **Trigger Mode** menu.
2. Select needed mode on **Trigger Mode** menu.

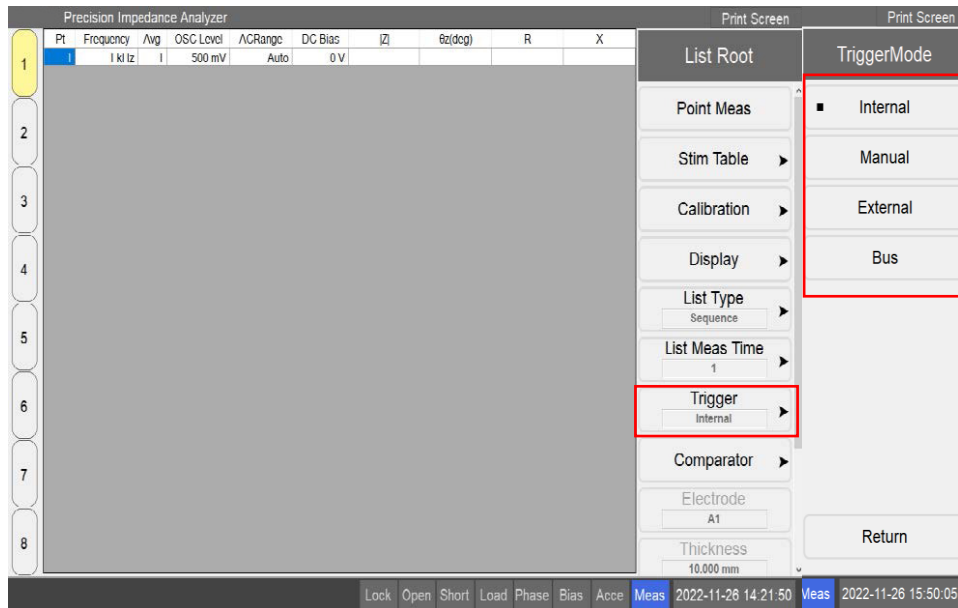

5.3.2 List Type

Operation steps below to modify list type:

1. Click **List Type** on **List Root** menu to enter **List Type** menu.
2. Select needed mode on **List Type** menu.

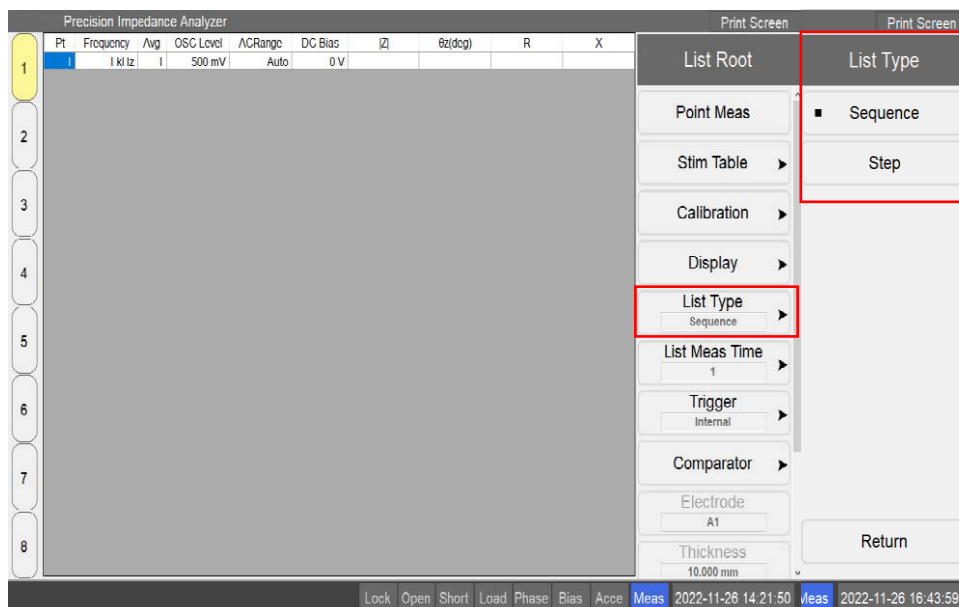

Type	Description
Sequence	When triggered, measure the remaining measurement points from the current measurement point to the end of the list. If the selected measurement point is at the end of the list when triggered, it will start from the first point.
Step	At each trigger, measure the currently selected measurement point, and then select the next point.

5.3.3 Point Delay

Operation steps below to modify the delay time of measurement points:

1. Click **Point Delay** cell that need to modify the value to enter the corresponding point menu.
2. Two operations to modify the value on the front panel: one is to press the digital buttons, and another is to press the directional buttons and turn the knob.

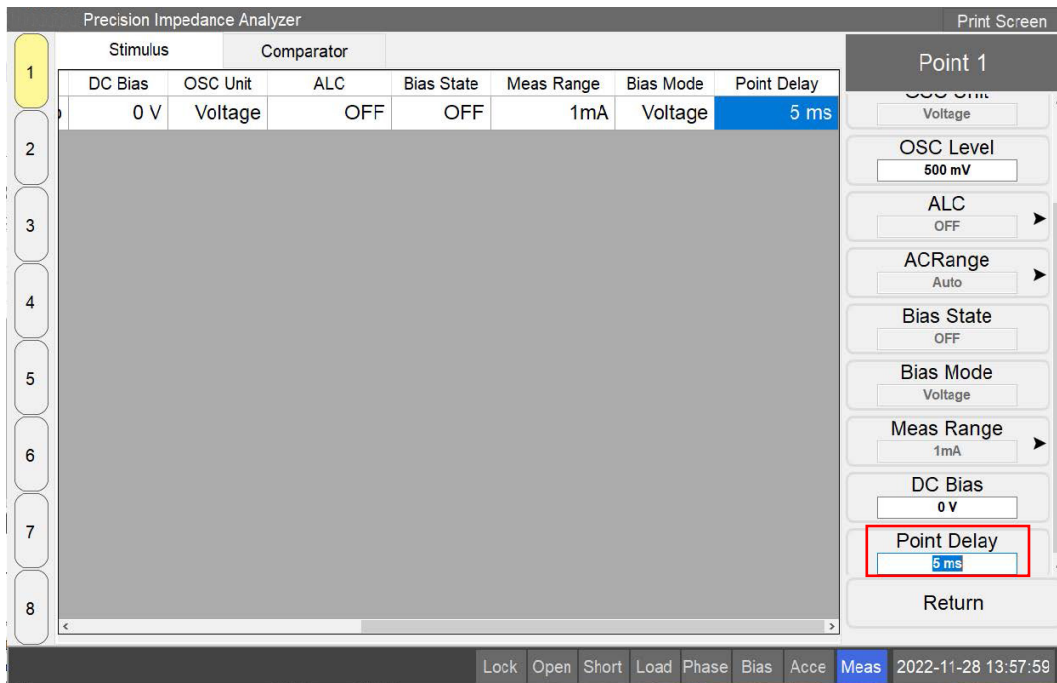

5.4 Result

5.4.1 Parameter

Operation steps below to set the parameters of measurement points:

1. Click **Display** on **List Root** menu to enter **Display** menu.
2. Click Parameter1~4 to modify the parameters.
3. See 4.10.1 for specific parameter selection.

NOTE: If the parameter is set to None, the column of the parameter will be hidden in the list.

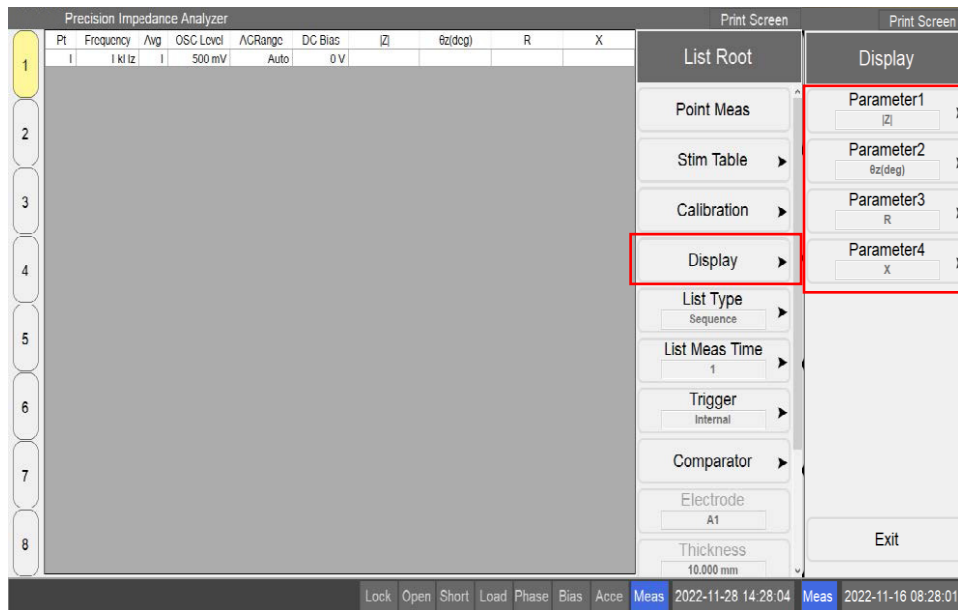

5.4.2 Comparator

Click **Comparator** at the top of **Stimulus Table** interface to enter **Comparator Table** interface.

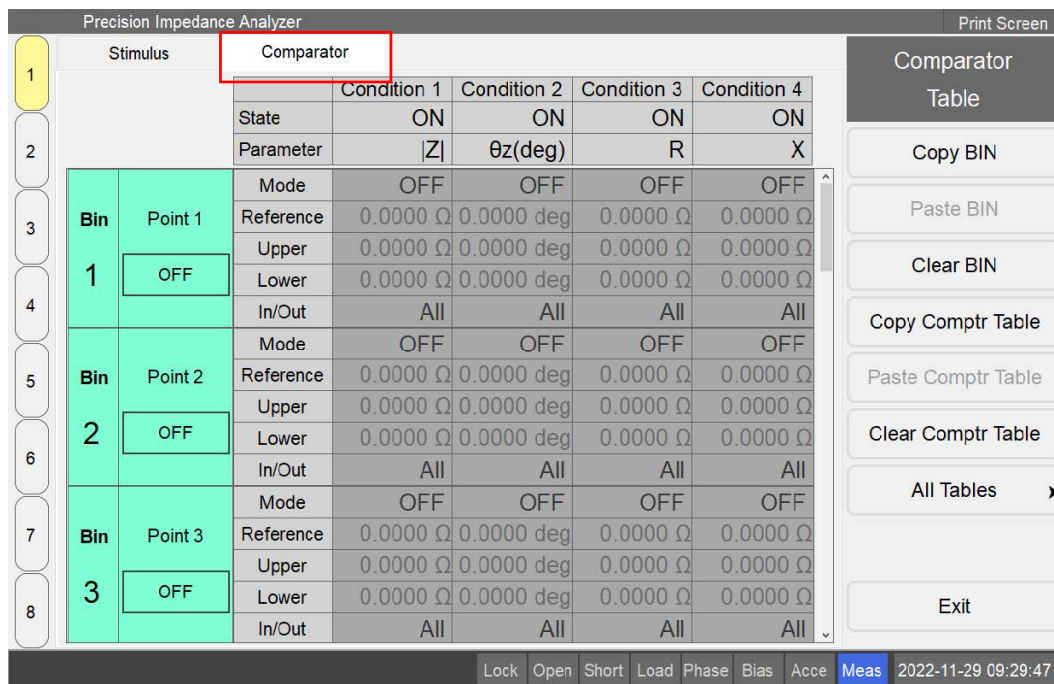

Related features of BIN setting as shown below:

1. The interface can be set up to 15 BIN and 4 conditions for the measurement results. And only when the BIN meets all current conditions, it can be counted as qualified.
2. Each BIN or Condition has own switch.
3. Each BIN corresponds to a measurement point in the list measurement, BIN1 corresponds to point 1, BIN2 corresponds to point 2, and so on.

4. If the measurement result does not belong to any BIN, it will be sorted to NG.
5. Only when the sorting results of all BIN whose states are on are qualified, the final sorting result is qualified, otherwise, the final result will be sorted to NG.
6. **The list sorting settings are similar to point measurement sorting, please refer to 4.9 and 4.10.**

Chapter 6 Trace Sweep Measurement

This chapter describes how to use the trace measurement mode for the sweep measurement and analysis, etc.

6.1 Setting Measurement Conditions

This section describes how to set up the measurement conditions in Sweep mode.

6.1.1 Initialization

The STB8851 has three initial modes, as shown in the following table:

Initialization mode	Description
Preset	Press Preset on the front panel, a confirmation dialog box will appear on the screen (you can close it in the settings), press OK button and execute it. Preset can be used to restore to factory settings or to restore to user settings (UserPres file is required), which can be confirmed and changed in the System Settings > Misc Setup > Preset Setup menu. Preset can also be implemented with the command :SYST:PRES
*RST	External input *RST command
Factory Settings	STB8851 Restore to Factory Settings

6.1.2 Setting Channels and Traces

6.1.2.1 Overview of Channels and Traces

The STB8851 allows multiple channels to be set up simultaneously to perform different measurement at different stimulus states.

Multiple traces (measurement parameters) can be displayed in each channel, and each channel is independent and not correlated with each other. In other words, you have to set the measurement conditions as well as the measurement parameters, etc. for each measured channel.

When you set up channels/traces, only the currently active channels/traces are applied. You can set only the active channels/traces to be displayed on the screen.

The following table lists the setting parameters by the STB8851, along with the scope of each variable (analyzer, channel, or trace) and the operating keys:

Parameters	Scope of action			Setup keys
	Analyzer	Channel	Traces	
Stimulus Setting				
Sweep Range		√		[Start], [Stop], [Center], [Span]
OSC Level, CW Frequency		√		[Sweep Setup] > OSC Level
Sweep Time, Point Delay		√		[Sweep Setup] > Sweep Time, Point Delay
Number of Points		√		[Sweep Setup] > Points
Segmented Display		√		[Sweep Setup] > Segmented Display
DC Bias		√		[Sweep Setup] > DC Bias
Trigger Settings				
Trigger Mode		√		[Trigger Mode] > Hold / Single / Continuous
Trigger Source, Trigger Event, Trigger Scope	√			[Trigger Mode] > Trigger Source / Trigger Event / Trigger Scope
Trigger	√			[Trigger Mode] > Restart/Trigger
Response Settings				
Measurement Parameter			√	[Meas]
Data Mode			√	[Format]
Scale			√	[Scale]
Memory Trace and Data Math			√	[Display] > Display / Data→Mem / Data Math
Averaging		√		[Avg] > Averaging Restart / Average Factor / Averaging
Averaging Trigger	√			[Avg] > Average trigger
Marker			√	[Marker] / [Marker] [Search] / [Marker] [Function]

Analysis				
Equivalent circuit			√	Analysis > Equivalent Circuit
Limit Line			√	Analysis > Limit Test
Save and Recall	√			Save/Recall
System				
System	√			System
Preset	√			Preset

The STB8851 sweep mode provides 4 channels with up to 4 traces per channel and a maximum of 1601 measurement points.

6.1.2.2 Setting Channel Display (Channel Layout)

The measurement results for each channel are presented in its separate window (channel window), and only one channel's trace can be displayed in each window. This means that the layout of channels depends on the number of channels currently displayed on screen.

Note: The measurement results for each channel are independent of the currently displayed channel (channels that are not displayed can also be tested).

Set the layout of channels according to the following steps:

1. Press **Display** on the front panel to open the Display menu, followed by **Allocate Channels** to open the Allocate menu.
2. Press the appropriate softkey to select the window layout.

6.1.2.3 Changing Active Channel

Only the active channels can change its setting parameters directly. The window frame of the active channel is displayed brighter than the other channels. If you need to change the parameters of a channel, you must activate the channel first.

The active channels can be switched via keys on the front panel:

Key	Function
Channel Next	Change the active channel to the next channel with a larger channel number
Channel Prev	Change the active channel to the previous channel with a smaller channel number

6.1.2.4 Setting Trace Display

You can define the display of traces by setting the number of traces (the upper limit of displayed trace numbers). For example, if you set the number of traces to 3, traces 1,2,3 are displayed in the channel.

Set the number of traces according to the following steps:

1. Switch to the desired channel via the **Channel Next** (or **Channel Prev**) key on the front panel.
2. Press **Display** on the front panel to open the Display menu.
3. Press **Num of Traces** to select the number of traces.

Traces are displayed in the channel according to the number of traces and the trace layout, and the layout of the trace is the same as the layout of the channel. If the number of traces is less than the number of traces in the layout, nothing is displayed in the remaining area; if the number of traces is more than the number of display areas in the distribution, more than one trace may appear in the existing display area. As shown in the figure below, if the number of traces is 4 and the number of display areas for trace distribution is 3, traces 1 and 2 will be displayed in the first display area, trace 3 in area 2, and trace 4 in area 3.

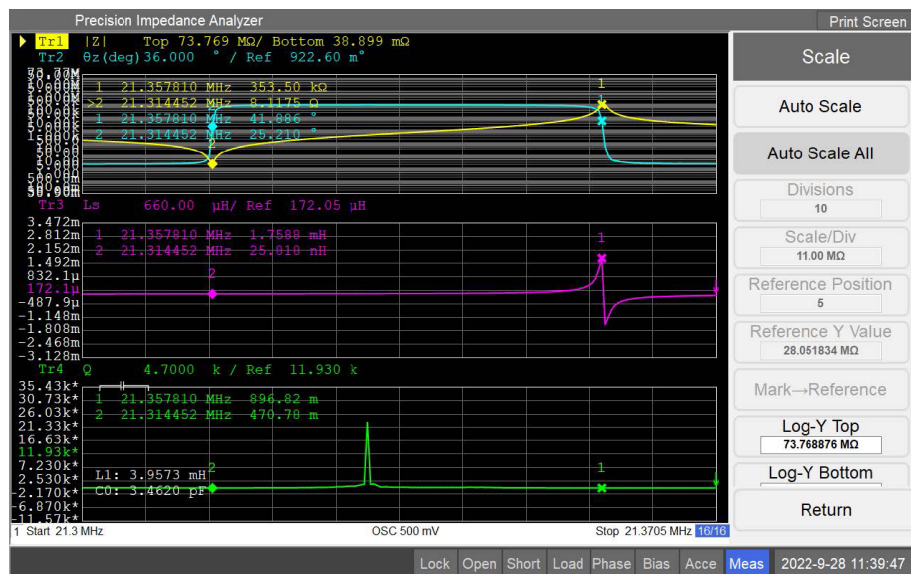

Set the distribution of the trace according to the following steps:

1. Switch to the channel to be set via the **Channel Next** (or **Channel Prev**) button.
2. Press **Display** on the front panel to open the Display menu.
3. Press **Allocate Traces** to select the trace allocation mode to be modified.

6.1.2.5 Channel and Trace Layout

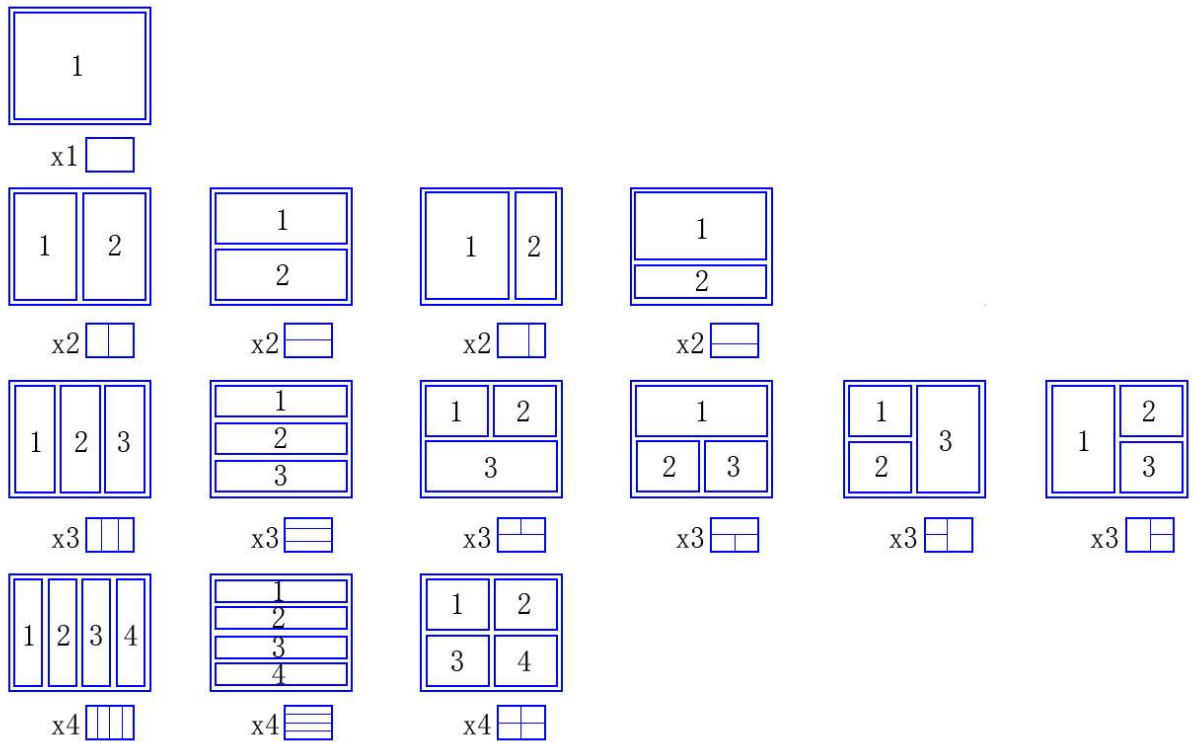

6.1.2.6 Changing Active Trace

The active trace is the only one whose parameters can be changed. On the screen, the active trace name (e.g., Tr1) is highlighted and labeled with a triangle on the left. Before changing the parameters specific to a trace, you must first activate the trace.

The active traces can be switched via the front panel keys:

Key Name	Function
Trace Next	The active trace changes from the current trace to the next trace with the larger trace number.
Trace Prev	The active trace changes from the current trace to the previous trace with the smaller trace number.

6.1.3 Sweep Parameters Settings

6.1.3.1 Selecting Sweep Type

Follow the steps below to select the sweep type:

1. Press **Sweep Type** on the front panel to enter the Sweep Type menu.

2. Press the corresponding button to select the sweep type: **Lin Freq** / **Log Freq** / **OSC Level** / **DC Bias** / **Log DC Bias** / **Segment**.

When the sweep type is OSC level or DC bias, it can be modified to voltage or current level. The DC bias will only work if the bias state in the sweep type is turned on, otherwise it will always be the default value.

Note: When the internal resistance of the analyzer is set to 100Ω in the system, the upper limit of the OSC level will change. The input range of voltage becomes: 5mV-2V, and the input range of current becomes: 50μA-20mA. It should be noted that the voltage can be set to greater than 1V and the current can be set to greater than 10mA only when the measurement frequency is not higher than 1MHz.

The sweep type is set for all traces in the entire channel, so there is no need to change the active trace.

6.1.3.2 Setting Sweep Range

The sweep range can be set either start/stop values or center/span values. The sweep range is set for all traces in the entire channel, so there is no need to change the active trace.

Set the sweep range with start/stop values:

1. Press **Start** on the front panel to enter the Stimulus menu and input the start value.
2. Press **Stop** on the front panel to input the stop value.

The start value should not be greater than the stop value. If the input start value is greater than the stop value, the stop value will be automatically set to match the start value. If a decreasing frequency measurement is required, you can set the frequency to increase and then set the direction to reverse.

Set the sweep range with center/span values:

1. Press **Center** on the front panel to enter the Stimulus menu and input the center value.
2. Press **Span** on the front panel to input the span value.

Set the sweep range with the marker:

1. Press **Marker Function** on the front panel to enter the Marker Function menu.
2. Press the corresponding setting softkey to set the sweep range, and the specific functions are shown in the table below.

Softkey	Function
Marker→Start	Set the start value to the stimulus value of the active marker on the currently active trace.
Marker → Stop	Set the stop value to the stimulus value of the active marker on the currently active trace.
Marker→Center	Set the center value to the stimulus value of the active marker on the currently active

	trace.
--	--------

Softkey	Function
Marker Zoom	Scale the sweep range according to the zoom aperture and places the stimulus value of the currently selected marker at the center value of the sweep range. This function focuses the sweep range around the marker and measures and plots the trace within that range.
Zoom Aperture	Set the zooming aperture used when the Marker Zoom is executed as a percentage. The value can range from 0.01% to 100%, and the default value of power-on and preset state is 10%.

6.1.3.3 Setting Number of Points

1. Press **Sweep Setup** on the front panel to access the Sweep Setup button.
2. In the input box of the **Points** button, input the number of points.

Note: The range of points is from 2 to 1601. If the number of points entered is greater than the current number of points, the default point will be added at the right stop of the trace; if the number of points entered is less than the current points, the extra points will be deleted in order from right to left.

6.1.3.4 Setting Sweep Direction

1. Press **Sweep Setup** on the front panel to access the Sweep Setup button.
2. Press **Direction** to switch the sweep direction.

Note: The sweep direction allows you to select the direction of the sweep. By default, the sweep direction is forward, scanning from left to right; when set to reverse, scanning from right to left.

6.1.3.5 Setting Time Delay for Measurement

The measurement delay can be set and used for a period before the sweep or actual measurement starts after the measurement signal is given. This function is important when the parameters of the DUT need a certain time to stabilize after the measurement signal is received. Another effect of this function is to observe the changes in the impedance of the DUT over a period of time.

The delay for each measurement point consists of two parts, set as shown in the following equation where the sweep time is not a proxy for the time required for the entire sweep process.

$$\text{Point Wait Time} = \text{Point Delay} + (\text{Sweep Time} / \text{Number of Points})$$

This feature helps reduce the effects of changes in the condition of the stimulus when measuring the slow response devices. This function is useful even if the span of the stimulus is 0.

When the trigger mode is at On Sweep:

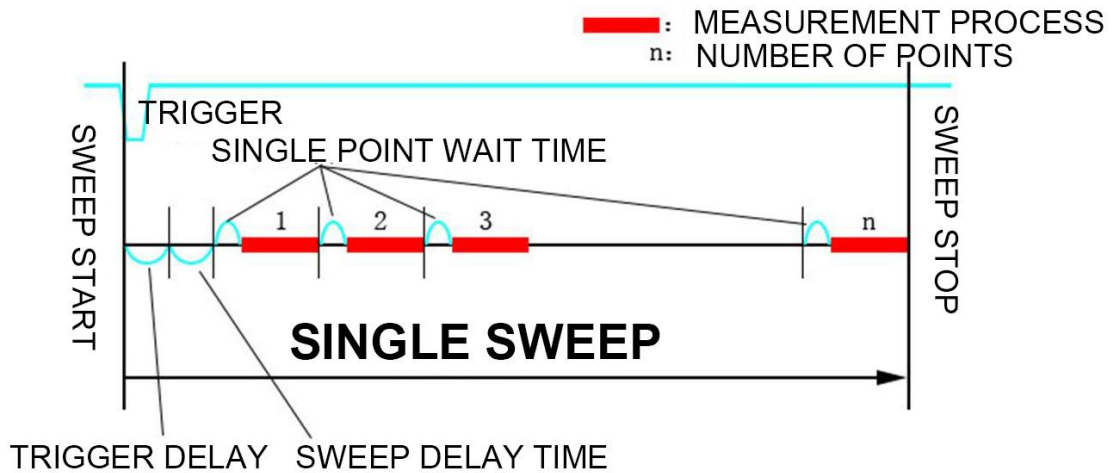

When the trigger mode is at On Point:

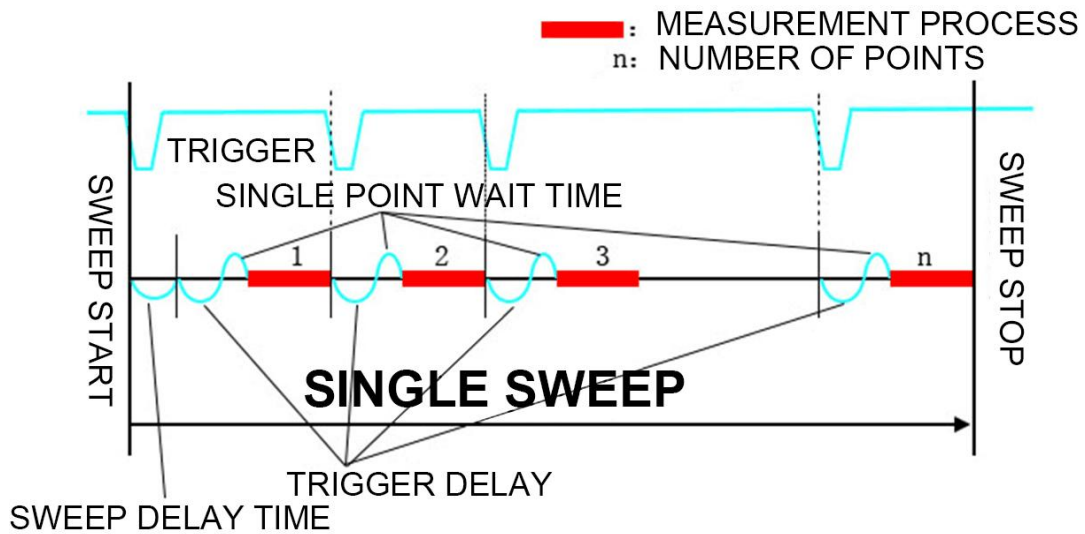

Modify the point delay and sweep time by following the steps below:

1. Press **Sweep Setup** on the front panel to enter the Sweep Setup menu and input the point delay value to be modified in the input box of the **Point Delay** button.
2. In the **Sweep Time** button's input box, input the sweep time value that needs to be modified.

The time delay can be set before the start of the sweep cycle. This delay is quite important in controlling the impact to the DUTs when starting the new sweep (In general, the stimulus conditions like frequency and OSC level change significantly when a sweep is completed to return to the first measurement point).

Sweep delay modification method: press **Sweep Setup** on the front panel to enter the Sweep Setup menu and input the delay value that needs to be modified in the input box of the **Sweep Delay** button.

6.1.3.6 Setting Sweep Time

1. Press **Avg** on the front panel to enter the **Average** menu.
2. Press **Meas Time** and select the desired measurement speed value. The options are 1/2/3/4/5, with 1 being the fastest speed and 5 being the most precise.

Note: Choosing a larger measurement speed will result in higher measurement accuracy but also require a longer measurement time.

6.1.3.7 Setting Sweep Averaging (Averaging)

The sweep averaging is averaged over each of multiple consecutive sweep cycles. The measurement result (vector value) of each measurement point is influenced by a certain weight (related to the average factor set by the user) with the measurement value of the same point in the completed sweep cycle. The formula for the sweep averaging is shown below:

$$A_n = \frac{S_n}{F} + \left(1 - \frac{1}{F}\right) \times A_{n-1}$$

A_n : The average result (vector value) at the current measurement point when the sweep count is n.

S_n : The actual measurement value (vector value) at the current measurement point when the sweep count is n.

F: Averaging factor, user setting required.

Set the average according to the following steps:

1. Press **Avg** on the front panel to enter the **Average** menu.
2. Press **Ave Factor** and input the desired value for the averaging factor value which can be set from 1 to 999. If set to 1, it is equivalent to turning off the averaging.
3. Press **Averaging** to toggle the ON/OFF status of the averaging.

Note: When the averaging is on, the value of the averaging is displayed on the bottom right corner of the status bar. The averaging starts once it's turned on or by pressing **Averaging Restart**. When the averaging starts, the averaging on the status bar will be displayed as the initial value of 0, increasing by 1 after each sweep is completed, and the value will remain unchanged when the averaging and the averaging factor are equal.

6.1.3.8 Making Averaging Measurement with Single Trigger

When the average trigger is turned on, if the averaging is turned on, a sweep equal to the number of times by the averaging factor will be performed when the user performs a single trigger mode.

Averaging Trigger	Function
ON	Single-trigger mode sweeps until the number of sweep cycles equals the average number of slides
OFF	Single-trigger mode sweeps for one sweep cycle only

Turn on the averaging trigger and perform a single trigger pattern as follows:

1. Press **Avg** on the front panel to open the Average menu.
2. Press **Avg Trigger** button to turn it on.
3. Press **Trigger Mode** on the front panel to enter the Trigger menu.
4. Press **Single** to perform one trigger.

6.1.3.9 Setting Averaging for Each Measurement Point

Single-point averaging is the averaging of measured values for each measurement point based on the number of single-point averages (factors) set by the user. The STB8851 measures the same measurement point repeatedly until the averaging factor is reached, and then averages all the measurements as the measurement result for that measurement point, and then starts measuring the next measurement point. The point averaging algorithm is displayed below:

$$M = \frac{1}{F} \sum_{n=1}^F S_n$$

M: Point averaging measurement (vector value) at the measurement point.

F: Point averaging factor (can be set by the user).

S_n : The measured value (vector value) of the current measurement point.

Set up the point averaging according to the following steps:

1. Press **Avg** on the front panel to enter the Average menu.
2. Press **Point Avg Factor** and set up the desired value, which can be set from 1 to 999, and if set to 1, is equivalent to point averaging off.
3. Press **Point Avg** to toggle the ON/OFF status of the point averaging.

6.1.3.10 Setting Trace Smooth

Smooth is a secondary processing to the data of the measurement trace, and when it is turned on, it will correct the measurement data in real time to make the trace display smoother. Modifying the

frequency, measurement parameters, etc. will automatically turn off the trace smoothing.

Set up trace smoothing as follows.

1. Press **Avg** on the front panel to enter the Average menu.
2. Press **Smooth** to toggle the ON/OFF status of the smooth.

6.1.4 Setting Signal Source

6.1.4.1 Modifying Fixed Frequency at OSC / DC Bias Sweep

When the sweep stimulus is not a frequency, modify the fixed frequency according to the following steps.

1. Press **Sweep Setup** on the front panel to enter the Sweep Setup menu.
2. Press **CW Frequency** to input a fixed frequency value.

Note: When the internal resistance of the instrument's signal source is set to 100Ω in the system, the range of the fixed frequency will interact with the settable range of OSC if the sweep mode is Level mode. When the voltage is set to greater than 1V/current is set to greater than 10mA, the maximum allowable setting of fixed frequency is 1MHz; when the fixed frequency has been set to greater than 1MHz, the upper limit of sweep voltage/current is 1V/10mA.

6.1.4.2 Setting Unit for OSC Level

1. Press **Sweep Setup** on the front panel to enter the Sweep Setup menu, followed by **OSC Level** to enter the OSC Level menu.
2. Press **OSC Unit** to change the source mode to Voltage/Current.

Note: The source mode set in the above step can be used to set the OSC level to the sweep stimulus value or to the sweep stimulus value at a fixed measurement level of a non-measurement level. The OSC level acts on all traces in the whole channel, so there is no need to change the active trace.

6.1.4.3 Setting Oscillator Level

1. Press **Sweep Setup** on the front panel to enter the Sweep Setup menu, followed by **OSC Level** to enter the OSC Level menu.
2. Depending on the source mode, the button **Voltage Level** and **Current Level** will be available and unavailable respectively. For example, if the source mode is Voltage, the button **Voltage Level** will be available, and then select and enter the voltage value.

Note: When the internal resistance of the instrument's signal source is set to 100Ω in the system, the upper limit of the OSC level changes. The voltage input range becomes: 5mV-2V, and the current input range becomes: 50μA-20mA. It should be noted that the voltage can be set to greater than 1V

and the current can be set to greater than 10mA only when the frequency (or the fixed frequency is in 6.1.4.1 when the sweep type is DC bias) is not higher than 1MHz; when the frequency is set to greater than 1MHz, the source level that has been set is automatically adjusted to the maximum allowed.

6.1.4.4 Controlling Oscillator Level (ALC)

1. Press **Sweep Setup** on the front panel to enter the Sweep Setup menu, followed by **OSC Level** to enter the OSC Level menu.
2. Press **ALC** to enter the ALC menu and press **ALC Control** to change the ALC state.
3. Press **Max Iteration** and input the desired maximum iteration value, ranging from 2 to 10.
4. Press **Target %** and input the desired value, 0.05 to 10.

6.1.4.5 Setting DC Bias Unit

Set the DC bias according to the following steps:

1. Press **Sweep Setup** on the front panel to enter the Sweep Setup menu, followed by **DC Bias** to enter the DC Bias menu.
2. Press **DC Bias Mode** to switch the DC bias mode to Voltage/Current.

Note: The bias mode set in this step can be used to set the DC bias to the sweep stimulus value or to the sweep stimulus value at a fixed measurement level of a non-measurement level. The DC bias is applied to all traces in the whole channel, so there is no need to switch the active trace.

6.1.4.6 Setting DC Bias Value

1. Press **Sweep Setup** on the front panel to enter the Sweep Setup menu, followed by **DC Bias** to enter the DC Bias menu.
2. Depending on the bias mode, the button **Voltage Level** and **Current Level** are available and unavailable, respectively. For example, if the bias mode is Voltage Level, the button **Voltage Level** will be available, and then press the Voltage Level and input the desired voltage value.

6.1.4.7 Setting DC Bias Measurement Range

Set the DC bias measurement range before turning on the DC bias. The DC bias measurement range is used to optimize the DC circuit transmitted to the impedance measurement loop. This setting affects the accuracy of the impedance measurement, regardless of whether the DC bias is On or Off and what mode it is. In general, setting the DC bias measurement range as small as possible can give the maximum measurement accuracy. It is recommended that the DC bias measurement range is set

to 1mA for the first measurement after the DC bias setting is applied.

When the DC bias is not turned on, 1mA will be the default setting and always work in the measurement.

Set the DC bias measurement range according to the following steps:

1. Press **Sweep Setup** on the front panel to enter the Sweep Setup menu, followed by **DC Bias** to enter the DC Bias menu.
2. Press **Meas Range** to enter the Meas Range menu and select the desired range value: 1mA/10mA/100mA.

6.1.5 Setting Trigger

6.1.5.1 Overview

When the STB8851 detects a trigger signal given by the user, it performs a sweep or point measurement in the channel depending on the trigger signal mode and events and other attributes.

The measurement process for each channel does not depend on whether that channel is displayed, and each channel can still be measured even if it is not displayed (appropriate settings are required).

6.1.5.2 Selecting Trigger Source

The trigger source integrates the signal that starts the measurement process. Press **Trigger Mode** on the front panel and subsequently press **Trigger Source**. The optional trigger sources and their descriptions are shown in the following table:

Trigger source	Function
Internal	A firmware-integrated continuous signal is used as the trigger source, and each measurement cycle is triggered immediately after the completion.
External	Use external trigger (Handler) as trigger source.
Manual	Trigger once when pressing the Trigger on the front panel.
Bus	A trigger is performed by commands received via GPIB/LAN/USB

6.1.5.3 Selecting Trigger Event

Press **Trigger Mode** on the front panel and subsequently switch by pressing **Trigger Event**. The available trigger events and their descriptions are shown in the following table:

Trigger Event	Function
On Sweep	Measure all measurement points in the whole cycle after each trigger.
On Point	Measure a single measurement point after each trigger.

Note: When the trigger source is internal trigger, the point trigger does not work.

6.1.5.4 Controlling Trigger

The user can set individual trigger modes for each channel, which allows the user to control the operation of each channel after receiving the trigger signal.

1. Switch to the desired channel via **Channel Next** (or **Channel Prev**) on the front panel.
2. Press **Trigger Mode** on the front panel to enter the Trigger menu and select the trigger mode. The selectable trigger mode buttons and their descriptions are shown in the following table:

Trigger Softkey	Function
Hold	Set the active channel to hold and stop sweeping immediately after pressing, any subsequent measurement will not be triggered.
Single	Set the active channel to single, switch to hold and stop measurement immediately after a measurement cycle.
Continuous	Set the active channel to continuous, the measurement signal is always triggered after the measurement cycle.
Hold All	Set all channels to hold.
Continuous Disp CH	Set all currently displayed channels to continuous.

6.1.5.5 Setting Trigger Scope

The trigger scope defines the range of channels that can be triggered currently. For example, if the trigger mode of all 4 channels is continuous mode and the trigger scope is set to the active channel, only the currently active channel can be triggered.

Press **Trigger Mode** on the front panel to enter the Trigger menu and switch by pressing Trigger Scope. The selectable trigger scopes and their descriptions are shown in the following table:

Trigger mode	Function
All Channel	All channels are triggered in sequence.
Active Channel	Trigger only for the currently active channel.

6.1.6 Measurement of Multiple Sweep Ranges with Different Conditions in a Single Action (Segment Sweep)

To perform a segment sweep, the user needs to define at least two frequency ranges, called segments. Each segment can be set with different number of points, OSC level, DC bias, measurement time, sweep time, sweep delay time, etc. All segments are swept sequentially in the same sweep operation.

Performing segment sweep allows the user to skip frequency ranges that do not need to be swept, while allowing different conditions to be measured for specific frequency ranges. For example, the number of points in some segments can be set as large as possible to obtain more accurate results,

while setting as few points as possible in some segments that do not require accurate results. By doing so, you can optimize the measurement time without having to perform a complete operation in a specific frequency range for the same measurement conditions.

To set up a segment, you need to enter Sweep Segment Setup screen and follow the steps below:

1. Press Sweep Setup on the front panel to enter the Sweep Setup menu.
2. Press Edit Segment Table to enter the segment table.
3. Press the following buttons to change the setting mode of the frequency range for each segment and the setting switches for each other measurement condition.

Set button	Function
Freq Mode	Toggle the setting mode of the frequency range (Start/Stop or Center/Span)
List OSC Level	Switch the OSC level setting for each segment, and only when it is turned on, the segment settings list shows the Source Mode and OSC Level
List Bias	Switch the OSC level setting for each segment, and only when it is turned on, the segment settings list shows the Bias mode and DC Bias
List Meas Time	Switch the OSC level setting for each segment, and only when it is turned on, the segment settings list shows the Meas Time
List Average	Switch the OSC level setting for each segment, and only when it is turned on, the segment settings list shows the Point Avg
List Segment State	Switch the OSC level setting for each segment, and only when it is turned on, the segment settings list shows the Segment Time
List Segment Delay	Switch the OSC level setting for each segment, and only when it is turned on, the segment settings list shows the Segment Delay

Apply the segment sweep list you have created by setting the sweep mode as follows:

1. Return to the sweep measurement interface and press **Sweep Type** on the front panel to enter the Sweep Type menu.
2. Press **Segment** button to apply the segment settings to the measurement.

After setting to segment sweep, you can set the methods of displaying segment traces as follows:

1. Press **Sweep Setup** on the front panel to enter the Sweep Setup menu.
2. Press **Segment Display** to switch the display mode: Order Base/Freq Base.

6.2 Setting Display Format of Measurement Result

This chapter describes how to set up the STB8851 to display the measurement results in a way that best suits the user.

6.2.1 Selecting Measurement Parameters

6.2.1.1 Simultaneous Selection of Measurement Parameters for Traces 1 and 2

1. Press **Meas** on the front panel to enter the Measurement menu.
2. Press **Trace 1&2** to enter the measurement parameter selection menu.
3. Select and press the button corresponding to the measurement parameter to be set. The buttons corresponding to the combinations of measurement parameters that can be selected are shown in the following table:

Available Options		Button
Trace 1	Trace 2	
Absolute impedance value	Impedance phase (angle)	$ Z -\theta_z$ (deg)
Equivalent circuit resistance	Equivalent circuit reactance	R-X
Equivalent circuit series inductance	Equivalent circuit series resistance	Ls-Rs
Equivalent circuit series inductance	Q factor (Quality factor)	Ls-Q
Equivalent circuit series capacitance	Equivalent circuit series resistance	Cs-Rs
Equivalent circuit series capacitance	Q factor (Quality factor)	Cs-Q
Equivalent circuit series capacitance	Dissipation factor	Cs-D
Absolute admittance	Admittance phase (angle)	$ Y -\theta_y$ (deg)
Equivalent circuit conductance	Equivalent circuit susceptance	G-B
Equivalent circuit parallel inductance	Equivalent circuit conductance	Lp-G
Equivalent circuit parallel inductance	Equivalent circuit parallel resistance	Lp-Rp
Equivalent circuit parallel inductance	Q factor (Quality factor)	Lp-Q
Equivalent circuit parallel capacitance	Equivalent circuit conductance	Cp-G
Equivalent circuit parallel capacitance	Equivalent circuit parallel resistance	Cp-Rp
Equivalent circuit parallel capacitance	Q factor (Quality factor)	Cp-Q
Equivalent circuit parallel capacitance	Dissipation factor	Cp-D
Absolute impedance value	Equivalent circuit series inductance	$ Z $ -Ls

Absolute impedance value	Equivalent circuit series capacitance	$ Z $ -Cs
Absolute impedance value	Equivalent circuit parallel inductance	$ Z $ -Lp
Absolute impedance value	Equivalent circuit parallel capacitance	$ Z $ -Cp
Absolute impedance value	Equivalent circuit series resistance	$ Z $ -Rs
Absolute impedance value	Q factor (Quality factor)	$ Z $ -Q
Absolute impedance value	Dissipation factor	$ Z $ -D
Magnetic permeability real part	Magnetic permeability imaginary part	μ_r' - μ_r'' (requires magnetic permeability module support)

Note: Each trace in the STB8851 has an independent vertical coordinate format, scaling data, memory trace, etc. Each trace is distinguished by measurement parameters. Selecting two measurement parameters at the same time makes it easier to detect the DUT through different angles by switching between different parameter combinations, thus making it easier to determine the type of the DUT.

6.2.1.2 Setting Measurement Parameters for Individual Trace

Set the measurement parameters for the individual traces according to the following steps:

1. Press **Meas** on the front panel to enter the Measurement menu.
2. Press **Trace 1**, **Trace 2**, **Trace 3** and **Trace 4** to enter the parameter setting menu of the corresponding trace. By default, the trace is 2. If you need to set Trace 3 and Trace 4, you need to set the number of traces first.
3. Select and press the button corresponding to the parameter to be set.

6.2.2 Setting Format of Y-Axis

The vertical coordinates corresponding to each trace can be set as linear or logarithmic axes according to the actual measurement, as follows:

1. Press **Format** on the front panel to access the Format menu.
2. Press **Y-Axis** to enter the Y-Axis menu and press the button of the axis type you need to set.

Note: If you select the logarithmic axis, the points in the trace whose vertical coordinate is less than 0 will automatically change the vertical coordinate to 1×10^{-18} .

6.2.3 Scaling Trace

6.2.3.1 Auto Scaling Trace

1. Activate the trace that needs to be scaled by **Trace Prev** and **Trace Next**.
2. Press **Scale** on the front panel to enter Scale menu and press **Auto Scale** to scale the active trace so that all measurement points of the active trace are visible in the coordinate system and the overall characteristics of the trace can be observed.
3. Press **Auto Scale All** to scale all current traces.

6.2.3.2 Manual Scale Settings

When the vertical coordinate is linear, the user can set the scaling of the trace by first setting the position of the reference value, then setting the reference value, and then you can set the scale value of each division. Operate according to the following steps:

1. Activate the trace that needs to be scaled by **Trace Prev** and **Trace Next**.
2. Press **Scale** on the front panel to enter the Scale menu, press **Reference Position**, input the position of the reference value scale relative to the bottom of the vertical coordinate, in the current state, the number of areas is 10, so the value can be set in the range of 0-10, the default is 5, that is, in the middle of the vertical coordinate, note that the reference value scale is a scale parallel to the horizontal coordinate, and its label text color is consistent with the corresponding trace.
3. Press **Reference Y Value** and input the desired vertical coordinate reference value, which is displayed on the vertical axis in the same color as the current trace.
4. Alternatively, if there is a selected marker displayed in the coordinate system, you can press **Marker Function** to open the Marker Function menu and press **Marker → Reference** to use the selected marker value as the reference Y value.
5. Press **Scale/Div** and input the scale value for each division.

When the axis is logarithmic, you can set the scaling of the trace by setting the maximum and minimum values of the vertical coordinates. Proceed according to the following steps:

1. Activate the trace that needs to be scaled by **Trace Prev** and **Trace Next**.
2. Press **Scale** on the front panel to enter the Scale menu, press **Log-Y Top** and input the upper limit value of the vertical coordinate that needs to be set.
3. Press **Log-Y Bottom** and enter the lower limit value of the vertical coordinate you need to set.

6.2.4 Comparison and Calculation of Trace

The traces in the STB8851 all contain two different trace types: data and memory. Data traces are always consistent with the measurement data of the current DUT, and memory traces acquire data from a certain point in time. The following table lists the two trace types and functions:

Trace Types	Function
Data Trace	Displays the current measurement data and calculation results (updated according to the sweep cycle)
Memory Trace	Stores and displays previously saved measured values (acquired when pressing Display > Data→Mem)

This feature increases the flexibility of the user's measurements, for example, Data traces and memory traces can be displayed and compared with each other on the same screen simultaneously or to display the results of data traces and memory traces calculated from each other.

6.2.4.1 Distinguishing between Data Trace and Memory Trace by Comparison and Calculation

1. Activate the trace that needs to be operated by **Trace Prev** and **Trace Next**.
2. Press **Display** on the front panel to enter the Display menu.
3. Press **Display** to select **Data** (only the data trace is displayed in the current coordinate system).
4. Start testing the DUT and then display the results.
5. At the moment, the user can stop (hold) the measurement trace by pressing the **Hold** button on the front panel, which ensures that the data trace can be accurately reproduced when the data is later stored into the memory trace.
6. Press **Data→Memory** and store measurement data into the memory trace.
7. The STB8851 provides a number of button options to control how the trace is displayed. Press **Display**, the optional buttons and corresponding display functions are shown below:

Softkeys	Function
Data	Displays data traces on the screen only
Mem	Displays the memory trace on the screen only
Data & Mem	Displays the data trace and memory trace on the screen simultaneously for easy comparison
OFF	None of the traces are displayed

8. At this point, you can start the measurement of the DUT to observe the two traces, or if you stopped the measurement before, you now need to restart it in the trigger menu.

Note: When the **Data→Mem** button is pressed, the memory trace will acquire the data on the current screen. The memory trace always acquires the measurement result, even if the current screen shows the result after the calculation. The **Data→Mem** button only works on the currently active trace. If you need to operate on other traces, you need to activate the trace first.

6.2.4.2 Setting Offset Operation

The user can set the mathematical offset with respect to the measured data, and the result of the operation is displayed through the data trace. The operation is performed according to the following steps:

1. Press **Display** > **Data→Mem** to store the measurement data.
2. Press **Data Math Offset** and input the desired offset value (0 in the default state).
3. Press **Data Math** and select the operation corresponding to one of the following buttons:

Buttons	Function
OFF	Turns off math operations
Data + Mem	Adds the measured data to the memory data and stores in data trace
Data - Mem	Subtracts the measured data from the memory data and stores in data trace
Data * Mem	Multiplies the measured data with the memory data and stores in data trace
Data / Mem	Divides the measured data by the memory data and stores result in data trace

4. Press **Display** and select the format of the trace display on the screen.
5. Start the measurement.

6.2.5 Monitoring Source Signal Level

6.2.5.1 Monitoring of AC Measurement Signal Level

In most cases, the actual AC voltage applied to the DUT will deviate from the setting value because the loss occurs between each measurement terminal and the DUT. The STB8851 provides a function that allows the user to monitor the actual source signal of AC voltage and current applied to the DUT, called "signal level monitor".

Set up level signal monitoring according to the following steps.

1. Press **Meas** to display the Measurement menu.
2. Press **OSC Monitor Trace** and set it to On, when the number of traces in the channel is set to 4, the measurement parameter of trace 3 is set to Vac, the measurement parameter of trace 4 is set to Iac, and traces 3 and 4 are the AC level monitoring traces.
3. Press **OSC Monitor Trace** and set it to Off, the number of traces in the channel is set to 2, trace 3 and 4 are not displayed.

6.2.5.2 Monitoring DC Bias Level

In most cases, the actual DC bias applied to the DUT will deviate from the set value due to losses between each measurement terminal and the DUT, and the STB8851 provides a function that allows the user to monitor the actual DC bias voltage and current applied to the DUT. This feature is called the “DC bias level monitor.”

The user can monitor the voltage and current values of the DC bias, which are refreshed before each sweep cycle and displayed in the upper right corner of the screen, labeled DCV and DCI.

Turn on the DC monitoring according to the following steps:

1. Press **Meas** to display the Measurement menu.
2. Press **DC Monitor Setup > DC Monitor** to toggle the ON/OFF status for DC bias monitoring.

6.2.6 Setting Form Display

6.2.6.1 Maximizing the display of specific channels/traces

When there are multiple channels, you can maximize the display of a specific channel on the screen; when there are multiple traces in the channel, you can also maximize the display of a specific trace in the channel form.

Switch the maximized display state of the channel according to the following steps:

1. Press **Channel Next** (or **Channel Prev**) to switch to the channel that needs to be set up.
2. Press **Channel Max** to maximize the channel form.
3. Press **Channel Max** again to restore the channel form to its original size.

Switch the maximum display state of the trace according to the following steps:

1. Press **Channel Next** (or **Channel Prev**) to switch to the channel where the trace to be set is located.
2. Press **Trace Next** (or **Trace Prev**) to switch to the trace that needs to be set.
3. Press **Trace Max** to maximize the trace within the channel window.
4. Press **Trace Max** again to restore the trace to its original size.

6.2.6.2 Turning Off Graticule Label Display

You can expand the display of the coordinate system by turning off the label display of the vertical coordinates. Follow the steps below.

1. Press **Channel Next** (or **Channel Prev**) to switch to the channel that needs to be set up.
2. Press **Display** on the front panel to enter the Display menu.
3. Press Graticule Label to toggle the ON/OFF status of the Graticule Label.

6.3 Analysis and Processing of Measurement Data

6.3.1 Analyzing Data by Marker

6.3.1.1 About Marker Function

The marker has the following uses:

1. Reading the value of the measurement result (as an absolute value or a relative value to the reference point).
2. Finding a specific point on a trace (marker search).
3. Analyzing trace measurement results and calculating statistical data.
4. Using the value of the marker to modify the stimulus as well as the scale.

The STB8851 can display 10 markers on each trace, including the reference marker. Each marker has a stimulus value (the value corresponding to the X-axis of the coordinate system) and a response value (the value corresponding to the Y-axis of the coordinate system).

6.3.1.2 Reading Marker Value on the Trace

The user can read the marker value displayed on the trace, and the response value of the marker is always in the same format as the Y-axis. When the sweep range is set to 0, the stimulus value of the marker is displayed as the serial number of the current measurement point. When the **Marker Function** > **Discrete** is turned off, the marker can be moved between measurement points by interpolation.

Open the marker on the trace according to the following steps:

1. Press **Channel Next** (or **Channel Prev**) and **Trace Next** (or **Trace Prev**) to activate the channel and trace on which a marker is used.
2. Press **Marker** to enter the Marker menu, press the marker button that needs to be opened to open the marker. The Marker button can be used to open or activate the marker.

Move the marker according to the following steps:

1. Press the button corresponding to the marker that needs to be moved and enter the new stimulus value. This enables you to move the position of the marker in the trace.
2. When the marker is active, the marker can be moved by sliding your finger across the

screen.

Close the marker according to the following steps:

1. Press **Marker** to enter the Marker menu.
2. Press **Clear Markers**, and then press the button corresponding to the marker that needs to be closed.

6.3.1.3 Reading Relative Value with Respect to Reference Point

The user can transform the marker value into a relative value with respect to the reference point.

Set the reference marker according to the following steps:

1. Press **Marker** to enter the Marker menu and press **Ref Marker** to open the reference marker.
2. Move the reference marker to the position that needs to be set as a reference point.
3. Activate the desired marker and move it to the desired position, the reading of the marker at this point is the value relative to the reference marker.

Note: Pressing **Marker** → **Ref Marker** can automatically open the reference marker and moves it to the currently active marker position.

6.3.1.4 Reading Interpolation between Actual Measurement Points/Measurement Points

Depending on the setting of the measurement points in the marker function, the points that can be positioned by the marker on the trace will differ, as shown in the following table:

Settings	Description
Turn ON discrete function	The marker can only be positioned to the actual measurement point. A marker stimulus setting value is automatically positioned to the nearest measurement point if it is between measurement points. The marker that sets between measurement points with the discrete function OFF is automatically positioned to the nearest measurement point when this function is turned on.
Turn OFF discrete function	The marker positioning can be not limited to the actual measurement point but can be positioned between the measurement points and obtain the response value at that location by interpolation.

Set the discrete mode according to the following steps:

1. Press **Channel Next** (or **Channel Prev**) to switch to the channel that needs to be set up.
2. Press **Marker Function** to enter the Marker Function menu.
3. Press **Discrete** to toggle the mode switch.

6.3.1.5 Setting up Marker Couple between traces

The marker can be set to move on all traces in the channel at the same time or on each trace individually.

Settings	Description
Marker Couple ON	The marker of the same number on all traces is set up and moved at the same time in the channel.
Marker Couple OFF	The marker on each trace is set up as well as moved individually.

Change the marker couple switch according to the following steps:

1. Press **Channel Next** (or **Channel Prev**) to switch to the channel that needs to be set up.
2. Press **Marker Function** to enter the Marker Function menu.
3. Press **Couple** and toggle the mode switch.

6.3.2 Searching Specific Measurement Point on a Trace

6.3.2.1 Overview

The user can search for a specific measurement point that meets the user's criteria by using the Marker Search function. Marker Search allows the user to search for measurement points with the following criteria:

Maximum value

Minimum value

Peak: contains positive peak (extreme values), negative peak (minimal values), the nearest peak to the left of the marker, and the nearest peak to the right of the marker.

Multiple Peak

Target: including the nearest target value to the marker, the nearest target value to the left of the marker, and the nearest target value to the right of the marker.

Multiple Target

6.3.2.2 Setting Search Range

The Marker Search function allows the user to use part of the sweep range as search range (Partial Search function).

Switch the Partial Search function ON and OFF according to the following steps:

1. Press **Channel Next** (or **Channel Prev**) to switch to the channel that needs to be set up.

2. Press **Marker Search** to enter the Marker Search menu and press **Search Range** to enter the Search Range menu.
3. Press **Search Range State** to toggle the ON/OFF status of the Search Range.

Set the search range according to the following steps:

1. Press **Channel Next** (or **Channel Prev**) to switch to the channel that needs to be set up.
2. Press **Marker Search** to enter the Marker Search menu and press **Search Range** to enter the Search Range menu.
3. Press **Search Range** to turn on the Search Range function.
4. Press **Start** to enter the lower limit value of the search range.
5. Press **Stop** to enter the upper limit value of the search range.

6.3.2.3 Auto-Complete Search (Marker Tracking)

The Marker Tracking feature automatically performs a search at the stop of each sweep cycle, even if the associated marker search button is not pressed. This feature allows the user to easily observe the measurement results, such as the maximum value of a trace.

Switch the marker tracking function on/off according to the following steps:

1. Press **Channel Next** (or **Channel Prev**) and **Trace Next** (or **Trace Prev**) to activate the channel and trace that need to be set up.
2. Press **Marker Search** to access the Marker Search menu.
3. Press **Tracking** to toggle the ON/OFF status of the tracking.

6.3.2.4 Searching for Maximum and Minimum Values

The user can search for the maximum and minimum value points on the measurement trace and move the marker to that point.

Search for the maximum or minimum value point according to the following steps:

1. Press **Channel Next** (or **Channel Prev**) and **Trace Next** (or **Trace Prev**) to activate the channel and trace that require the use of the marker.
2. Activate the marker that needs to be used for searching for.
3. Press **Marker Search** to access the Marker Search menu.
4. Press **Max** or **Min** to complete the search.

6.3.2.5 Searching for Peak

The Search Peak function allows the user to search for the peaks on a trace.

Peaks are measurement points on the trace where the measured value is greater or less than two adjacent points on the left and right. Depending on the quantitative relationship between the measured value and the adjacent measurement points, the peaks can be classified into the following two categories:

Positive	That is, the maximal value, the measured value is greater than the adjacent measurement points on the left and right
Negative	That is, the minimal value, the measured value is less than the adjacent measurement points on the left and right

The peak excursion is defined as the minimum difference (absolute value) between the measured value at the peak point and the measured value at the adjacent measurement point.

There are three ways to find the peaks as follows:

Search peaks	Move the marker to the closest point that matches the search criteria
Search left	Move the marker to the closest point on the left that matches the search criteria
Search right	Move the marker to the closest point on the right that matches the search criteria

Set up according to the following steps:

1. Press **Channel Next** (or **Channel Prev**) and **Trace Next** (or **Trace Prev**) to activate the channel and trace that require the use of the marker.
2. Activate the marker that needs to be used for searching for.
3. Press **Marker Search** to enter the Marker Search menu and press **Peak** to enter the Peak menu.
4. Press **Peak Excursion** to enter the desired peak excursion, a value that defines the minimum value of the difference between the peak point and the measured value of the adjacent measurement point.
5. Press **Peak Polarity** and select the type of peak to search for (Both, Positive, Negative).
6. Press the corresponding search button (**Search Peak**, **Search Left**, **Search Right**) to perform a peak search.

6.3.2.6 Searching for Multiple Peaks

Searching for multiple peaks allows the user to search for multiple peaks on a trace. The peak points and peak excursion are set in the same way as Search Peaks. When the STB8851 finds a peak point that meets the criteria, it automatically moves the marker to that point. Depending on the number of

peak points, markers 1-9 are sequentially arranged from the starting frequency order. Note that the reference point marker is not affected.

Search for the multiple peaks according to the following steps:

1. Press **Channel Next** (or **Channel Prev**) and **Trace Next** (or **Trace Prev**) to activate the channel and trace that require the use of the marker.
2. Press **Marker Search** to enter the Marker Search menu and press **Multiple Peaks** to enter the Multiple Peaks menu.
3. Press **Peak Excursion** to enter the desired peak excursion, a value that defines the minimum value of the difference between the peak point and the measured value of the adjacent measurement point.
4. Press **Peak Polarity** and select the type of peak to search for (Both, Positive, Negative).
5. Press **Search Multi Peak** to complete the multiple peaks search.

6.3.2.7 Searching for Target Value

The Search Target Value is a function that searches for the measurement point on the trace where the measurement value matches the target value and the trends of data change (Positive, Negative, Both), while moving the marker to that point.

The target value point is the measurement point on the trace where the measured value is equal to the set target value. Depending on the trends of data change at the measurement point, it can be classified into two types:

Target Transition Type (Positive)	The data of the measurement point is greater than the data of the adjacent measurement point on the left
Target Transition Type (Negative)	The data of the measurement point is smaller than the data of the adjacent measurement point on the left

STB8851 provides the following three ways to search for the target value:

Search Target	The marker moves to the measurement point where the nearest measured value is equal to the target value
Search Left	The marker moves to the measurement point on the left where the closest measurement value is equal to the target value
Search Right	The marker moves to the measurement point on the right where the closest measurement value is equal to the target value

Find the target value according to the following steps.

1. Press **Channel Next** (or **Channel Prev**) and **Trace Next** (or **Trace Prev**) to activate the channel and trace that require the use of the marker.
2. Activate the marker that needs to be used for searching for.

3. Press **Marker Search** to enter the Marker Search menu and press **Target** to enter the Target menu.
4. Press **Target Value** and input the target value that needs to be set up.
5. Press **Target Transition** and select the target transition that needs to be set up.
6. Press the corresponding search button (**Search Target**, **Search Left**, **Search Right**) to perform a target value search.

6.3.2.8 Searching for Multiple Target Values

Searching for Multiple Target Values allows the user to search for multiple target values on the trace. The target value point and target value are set to match the search target value. When the STB8851 finds a target value point that meets the criteria, it automatically moves the marker to that point. Depending on the number of target points, markers 1-9 are sequentially arranged from the starting frequency order. Note that the reference point marker is not affected.

Perform a multiple target value search according to the following steps.

1. Press **Channel Next** (or **Channel Prev**) and **Trace Next** (or **Trace Prev**) to activate the channel and trace that require the use of the marker.
2. Press **Marker Search** to enter the Marker Search menu and press **Multi Target** to enter the Multi Target menu.
3. Press **Target** and input the target value that needs to be set up.
4. Press **Target Transition** and select the target transition that needs to be set up.
5. Press **Search Multi Target** to complete the search for multiple target values.







6.3.3 Analyzing Equivalent Circuit and Simulate Frequency Characteristics

6.3.3.1 Equivalent Circuit Analysis based on Measurement Results

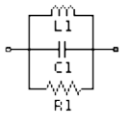
Perform the equivalent circuit analysis operation according to the following steps:

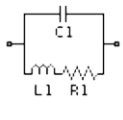
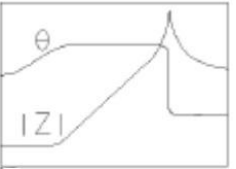
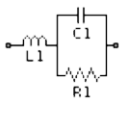
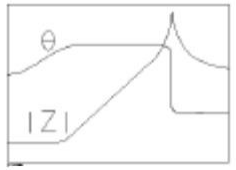
1. To perform trace sweep with frequency as the stimulus value.
2. Press **Analysis** > **Equivalent Circuit** > **Select Circuit**.
3. Select the equivalent circuit model according to the following table:

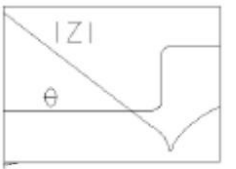
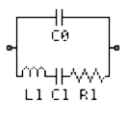
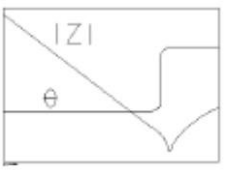
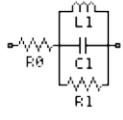
Equivalent Circuit Model	Frequency Characteristics	Example of DUT
--------------------------	---------------------------	----------------

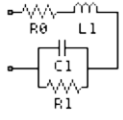
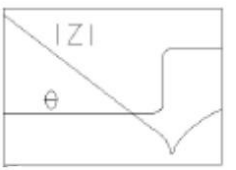
A			Inductor with high loss
B			Inductor, resistor
C			High value resistor
D			Capacitor
E			Resonator
F			Inductor with equivalent series resistance
G			Capacitor

In the frequency characteristic plot in the above table, the measurement parameters are all $|Z|-\theta_z$ (deg), the sweep type is logarithmic sweep, the vertical coordinate of $|Z|$ is the logarithmic axis, and the vertical coordinate of θ_z (deg) is the linear axis

4. Press **Calculate** to perform equivalent circuit analysis calculation and the calculated parameters $R1, C1, L1, R0, C0$ are displayed in the corresponding input box.

6.3.3.2 Simulating Frequency Characteristics based on Equivalent Circuit Parameters

The frequency characteristics are simulated according to the following steps:

1. To perform trace sweep with frequency as the stimulus value.
2. Press **Analysis** > **Equivalent Circuit** > **Select Circuit**.
3. Select the equivalent circuit model.
4. Press **R1**, **C1**, **L1**, **R0**, **C0** to select and input the equivalent circuit parameters that need to be modified.

Equivalent Circuit parameters	Description
R1	Resistance R1 in the equivalent circuit
C1	Capacitance C1 in the equivalent circuit
L1	Inductance L1 in the equivalent circuit
C0	Capacitance C0 in the equivalent circuit model E
R0	Capacitance R0 in the equivalent circuit model F, G

5. Press **Stimulate** to toggle it to ON and complete the simulation of the frequency characteristics.
6. Press **Display** to toggle it to ON, and the current equivalent circuit model and the values of the equivalent circuit parameters are displayed on the bottom left corner.
7. Press **Export** to save the equivalent circuit parameters and model.

6.3.4 Crystal Oscillator Analysis

You can measure and analyze the performance of crystals such as piezoceramics, and obtain important parameters such as resonant frequency, anti-resonant frequency, and quality factor of the crystal after measurement and calculation.

6.3.4.1 Opening Crystal Oscillator Analysis

Set the crystal oscillator analysis switch state according to the following steps:

1. To perform trace sweep with frequency as the stimulus value.
2. Press **Analysis** > **OSC Analysis**.
3. Press **State** to toggle the ON/OFF status.

Crystal oscillator analysis is a frequency-based trace analysis and calculation, so this function can only be turned on when the sweep type is frequency mode (both linear and logarithmic frequencies are possible).

When the crystal oscillator analysis function is turned on, the instrument performs a measurement at a frequency of 1 kHz after each trace sweep cycle, and then analyzes and calculates each parameter based on the measurement results, which are displayed in the menu on the right.

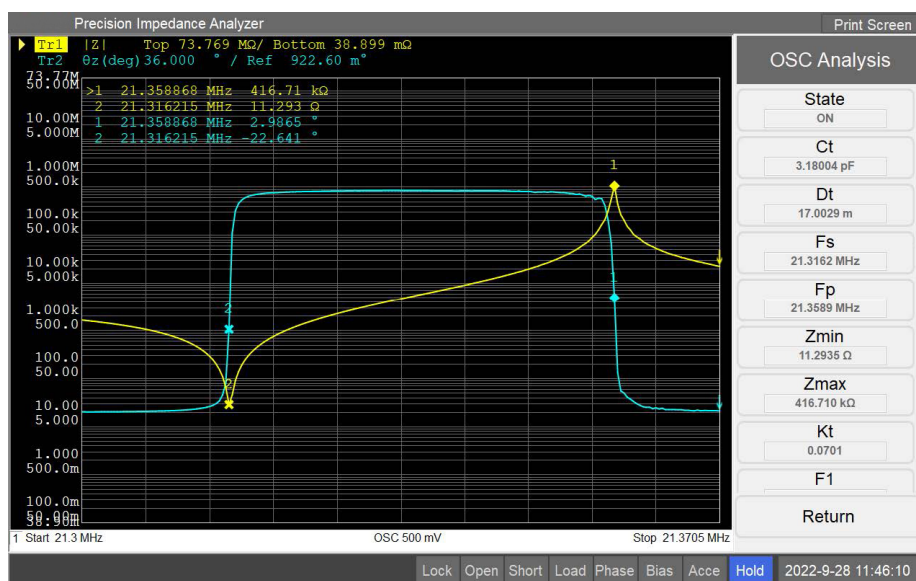

6.3.4.2 Setting Quality Factor Calculation Formula

According to the actual situation, choose the formula for the quality factor Q_m :

1. To perform trace sweep with frequency as the stimulus value.
2. Press **Analysis** > **OSC Analysis** > **Q Equation**.
3. Select the corresponding formula button and press it to set up

6.3.4.3 Showing Admittance Circle

With the crystal oscillator analysis function turned on, a real-time refresh of the admittance chart is displayed, and intercept the admittance circle image.

1. Turn on the crystal oscillator analysis switch for the current channel, see 6.3.4.1.
2. Press **Admittance** to display the admittance window for the current channel.
3. Press **Screenshot** to save the admittance image.

6.3.5 Trace Statistical Data

The user can obtain statistical data on the trace, including range, mean, standard deviation, and peak-to-peak values. The statistics are defined as shown below, only for the trace between marker 1 and 2, markers 1 and 2 are turned on automatically.

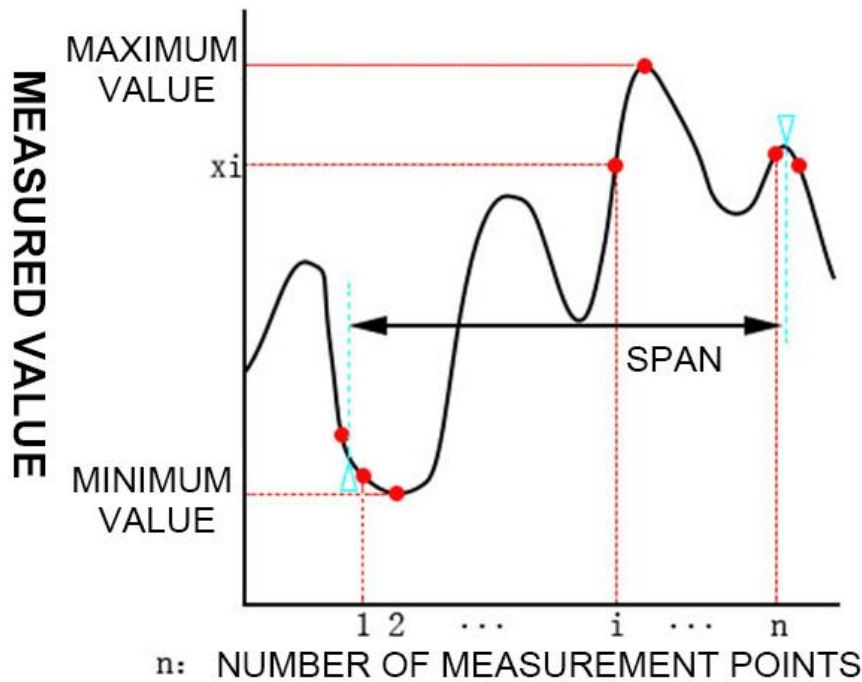

Statistical data element	Description
Range (span)	Span between marker 1 and 2
Mean value (mean)	$\frac{\sum_{i=1}^n x_i}{n}$ n is the number of measurement points between markers 1 and 2, and xi is the measurement value at the i-th measurement point
Standard deviation (s.dev)	$\sqrt{\frac{\sum_{i=1}^n (x_i - \text{mean})^2}{n-1}}$ n is the number of measurement points between markers 1 and 2, xi is the measurement value at the i-th measurement point, and mean is the average value
Peak-to-peak (p-p)	The difference between the maximum and minimum values between marker 1 and marker 2

Switch the display of the statistics according to the following steps:

1. Press **Channel Next** (or **Channel Prev**) and **Trace Next** (or **Trace Prev**) to activate the channel and trace that require the use of the marker.
2. Press **Marker Function** to enter the Marker Function menu and press **Statistics** to switch to ON.
3. Markers 1 and 2 are automatically turned on, move to the appropriate position, and the statistics are displayed on the upper left of the coordinate system.

6.3.6 Trace Limit Line

The trace limit line feature allows the user to set a pass range for each trace and determine if the measurement results pass or fail.

The user can add limit lines to certain intervals in the sweep range, which contain the upper and lower limits of the passing value. The measured value of the measurement point contained in the limit line must be between the upper and lower limits to be considered a pass point, and vice versa. If there is a fail point in the trace, the trace is judged to be a failure (Fail).

6.3.6.1 Setting Limit Line

Setting the limit line first needs to set a standard trace as a reference value, the upper and lower limits of the limit line is set up based on the setting of the reference trace, according to the following steps:

1. To perform a measurement with a standard test piece to obtain a standard trace.
2. Press **Channel Next** (or **Channel Prev**) and **Trace Next** (or **Trace Prev**) to activate the trace on which the limit test is used.
3. Press **Analysis** > **Limit Test** to enter the Limit Test menu.
4. Press **Data**→**Reference** to set the active trace as the reference value.

After setting up the reference value, the button **Edit Limit Line** become available, press to enter the list limit test interface, and set up the limit line

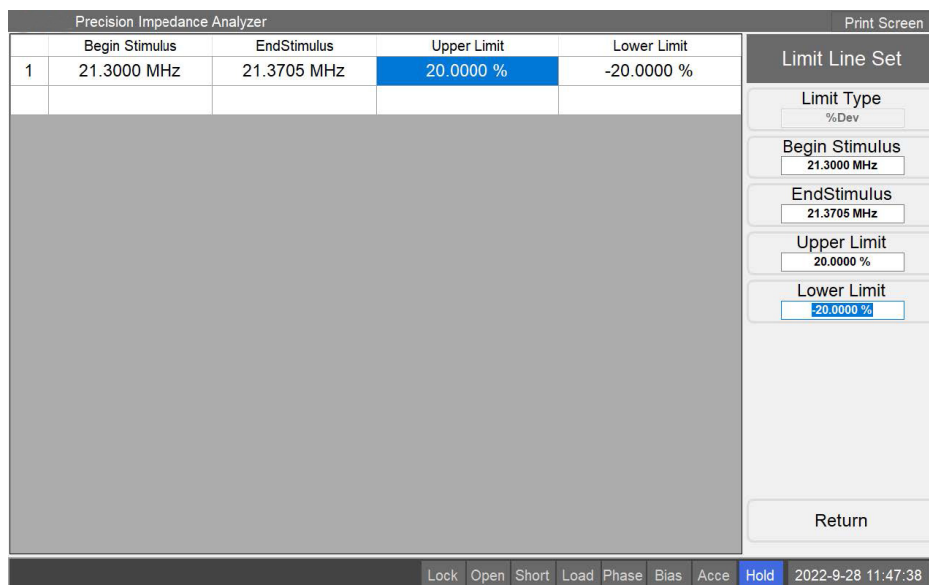

1. Press **Add** to add a new limit line.
2. Press the row where the limit line is located to enter the Limit Test menu.

3. Set the parameters in the limit line according to the following table:

Limit Line Set Parameters	Description
Limit Type	The types of upper and lower limits of the qualifying values in the limit line are selected as follows: ABS: the upper and lower limits are definite values. Dev: the upper and lower limits are the differences from the set reference trace. %: the upper and lower limits are percentages relative to the set reference trace. % Dev: the upper and lower limits are percentages of the difference with respect to the set reference trace.
Begin Stimulus	Starting value of the stimulus value on the limit line
End Stimulus	Ending value of the stimulus value on the limit line
Upper Limit	Upper limit of qualified measurements on the limit line, data type depends on the limit line type
Lower Limit	Lower limit of qualified measurements on the limit line, data type depends on the limit line type

4. After setting up, you can export the set data to a file/import existing data from a file by using the **Export/Import** button.

6.3.6.2 Proceeding Limit Line of Measurement Trace

1. Press **Analysis** > **Limit Test** to enter the Limit Test menu.
2. Press **Limit Line** to toggle it ON, and the limit line is displayed in the coordinate system.
3. Press **Limit Line** to toggle it ON and start to perform the limit line of the current measurement trace.
4. The limit line results are displayed at the position of the trace state above the coordinate system.

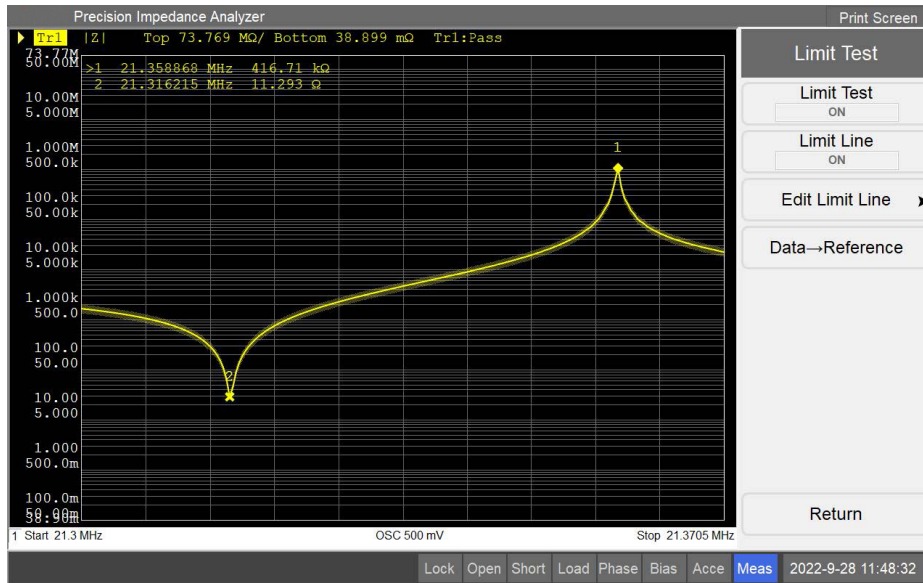

6.3.7 Trace Trails Comparison

The trace trails comparison is for continuous measurement of many different DUT, all traces are displayed in the same coordinate system, and the trace trails under different measurement conditions can be compared. At the same time, different frequency points can be set up and the measured values of all traces at that frequency point can be calculated.

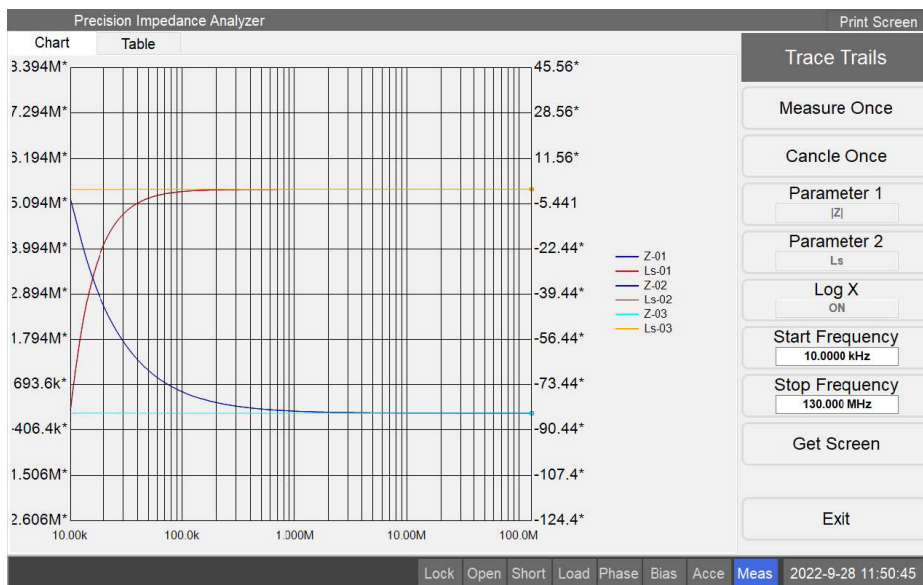

Trace trails measurement steps:

1. Press **Parameter 1** and **Parameter 2** to set the parameters that need to be measured, noting that modifying the measurement parameters can clear the measured traces and data.
2. Press **Log X** and set the horizontal coordinate to logarithmic or linear axis, noting that modifying the axis can clear the measured trace and data.
3. Set the start and stop frequencies, noting that setting the frequency can clear the measured

traces and data.

4. Press **Measure Once** can perform a sweep and press **Cancel Once** can cancel the previous measurement trace.

5. After completing the measurement, replace the DUT and press **Measure Once** again for the next measurement.

6. Repeat steps 5 and 6 until the measurement is complete, up to 10 measurements (20 traces in total).

7. Press **Get Screen** to save the current measurement image.

The screenshot shows the Precision Impedance Analyzer interface. At the top, there are tabs for 'Chart' and 'Table', with 'Table' selected. A 'Print Screen' button is in the top right. The main area contains a table with the following data:

Frequency	Z-01	Is-01	Z-02	Is-02	Z-03	Is-03
10.0000 kHz	5.21251 MΩ	-82.9552 H	5.21289 MΩ	-82.9604 H	21.5190 Ω	-246.340 μH
100.000 kHz	521.004 kΩ	-829.844 mH	521.111 kΩ	-830.012 mH	837.588 Ω	-1.33412 mH
1.00000 MHz	51.8384 kΩ	-8.25523 mH	51.8369 kΩ	-8.25499 mH	83.9397 Ω	-13.3664 μH
10.0000 MHz	4.85687 kΩ	-62.6394 μH	4.85705 kΩ	-62.6310 μH	5.35021 Ω	-62.2178 nH
100.000 MHz	492.372 Ω	-784.331 nH	491.721 Ω	-783.294 nH	27.0224 Ω	42.9872 nH

Below the table is a large grey area for a chart. To the right of the table is a 'Trails Table' panel with buttons: 'Frequency' (with an input field), 'Add Line', 'Delete Line', 'Calculate', 'Export Data', and 'Exit'. At the bottom of the interface, there is a status bar with buttons: 'Lock', 'Open', 'Short', 'Load', 'Phase', 'Bias', 'Acce', 'Meas', and a timestamp '2022-9-28 11:51:12'.

Press **Data** tab at the top to switch to the data table and set the frequency point at which the data needs to be read, as follows:

1. Press **Add Line** to add a new row to the trails table.
2. Select the line and then, in the **Frequency** button, modify the frequency that needs to be read.
3. Repeat steps 1 and 2 to complete the frequency setting.
4. Press **Calculate** can calculate the measurement data for the corresponding frequency point based on the previously measured trace and display it on the data table.
5. Press **Export Data** to export the measurement data from the data table to the hard disk.

Chapter 7 Save and Recall

7.1 Point Measurement

7.1.1 Save

Operation steps below to save point measurement settings:

1. When in the point measurement interface, press **Save/Recall** on the front panel to enter **Save/Recall** menu, then click **Save State** to enter **Save State** menu.
2. Select and click needed state to save settings.



3. The specific key meanings are as follows:

Key	Description
State 01~08	Save the setting status in the file corresponding to the serial number.
Autorec	Save the setting status in the auto save file. When Start From Setup of system setting is set to Auto , STB8851 will automatically save the device status on a regular basis. The saved file name is SaveData\PointAutorec.sta, and the automatically saved file will be overwritten. When the auto saved file can be detected during startup, it will be loaded.
UserPres	Save the setting status in the user saved file. The user saved file can be used to start loading or initialization. It needs to be changed in the system settings.
File	Customize the save location and file name.

NOTE: If the key name is marked with "*", it means that there is a saved file in the save field. Click this button to prompt whether to overwrite the existing file, and click OK to save and overwrite it.

7.1.2 Recall

Operation steps below to load point measurement settings:

1. When in the point measurement interface, press **Save/Recall** on the front panel to enter **Save/Recall** menu, then click **Recall State** to enter **Recall State** menu.
2. Select and click needed state to load settings.



3. If a saved file exists in **State01~08/Autorec/UserPres**, the corresponding key will be available, and click the key to load the saved file.
4. If you need to load a saved file with any name at any location in the hard disk, click **Recall State**, select the needed file to load in the pop-up window, and press open to load it.

7.1.3 Screen Capture

Operation steps below to save screenshot:

1. When in the needed interface, press **Save/Recall** on the front panel to enter **Save/Recall** menu, then click **Dump Screen Image** to pop up window.
2. Locate the location to be saved in the navigation window, enter an appropriate file name, and save the picture.
3. This function can also be achieved by click **Dump Screen Image** on **System** menu.

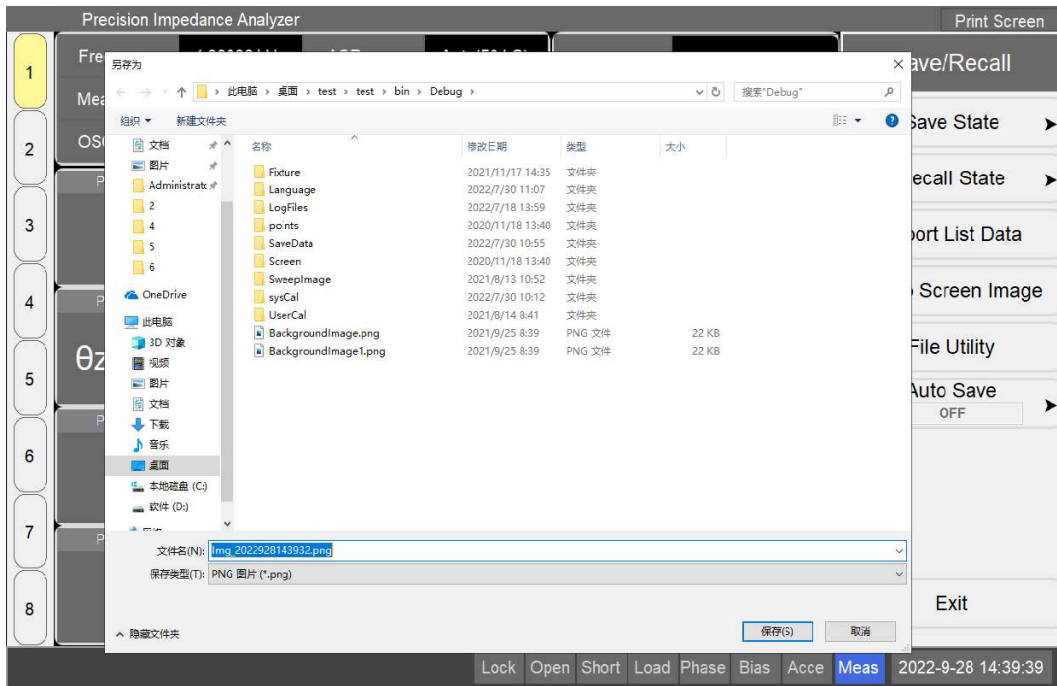

7.2 List Measurement

Operation steps below to save list settings:

1. When in the point/list measurement interface, press **Save/Recall** on the front panel to enter **Save/Recall** menu, then click **Export List Data** to pop up save window.
2. Locate the location to be saved in the navigation window, enter an appropriate file name, and save the file.

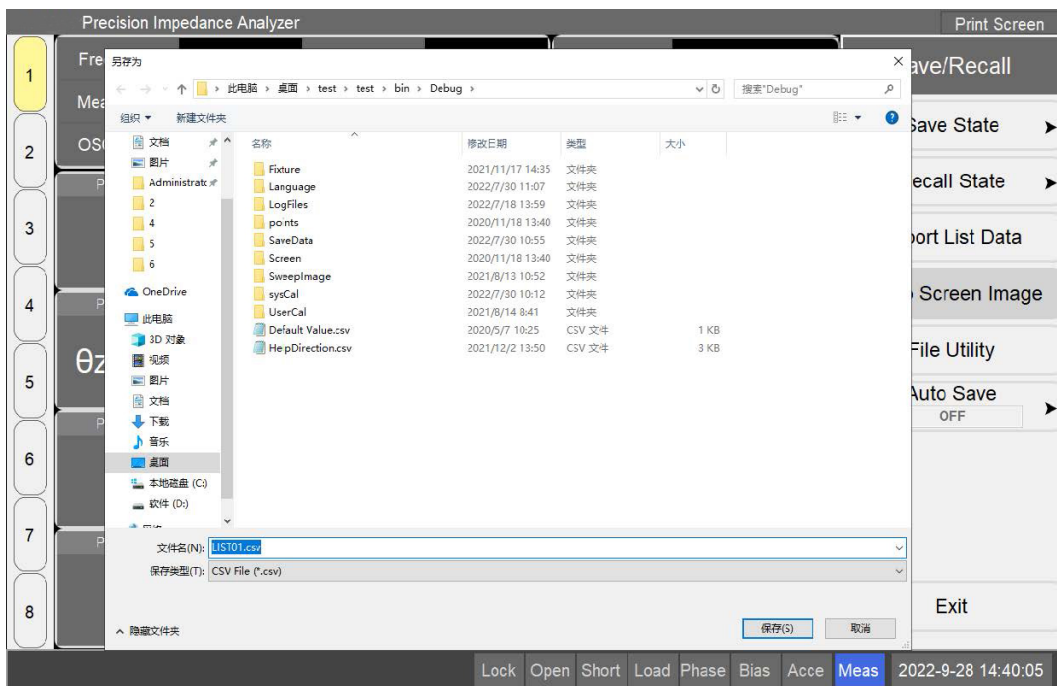

3. The default file format for export is .csv.
4. The saved file format as shown below:

```

LIST01.csv - 记事本
文件(F) 编辑(E) 格式(O) 查看(V) 帮助(H)
TONGHUI TH2851
Date:Friday 14 May 2021 08:19:34

BEGIN TABLE1
Frequency,Avg,OSC Voltage,OSC Current,OSC Mode,ALC,AC Range,Bias Voltage,Bias Current,Bias State,Bias Mod
e,Meas Range,Point Delay,|Z|,theta-z(deg),R,X
+1.000000000000E+03,1,+5.000000000000E-01,+2.000000000000E-02,Voltage,OFF,Auto,+0.000000000000E+00,
+0.000000000000E+00,OFF,Voltage,1mA,+0.000000000000E+00,+0.000000000000E+00,+0.000000000000E+00,
+0.000000000000E+00,+0.000000000000E+00
END TABLE1

BEGIN TABLE2
Frequency,Avg,OSC Voltage,OSC Current,OSC Mode,ALC,AC Range,Bias Voltage,Bias Current,Bias State,Bias Mod
e,Meas Range,Point Delay,|Z|,Cs,Cp,D
+1.000000000000E+03,1,+5.000000000000E-01,+2.000000000000E-02,Voltage,OFF,Auto,+0.000000000000E+00,
+0.000000000000E+00,OFF,Voltage,1mA,+0.000000000000E+00,+0.000000000000E+00,+0.000000000000E+00,
+0.000000000000E+00,+0.000000000000E+00
END TABLE2

BEGIN TABLE3
Frequency,Avg,OSC Voltage,OSC Current,OSC Mode,ALC,AC Range,Bias Voltage,Bias Current,Bias State,Bias Mod
e,Meas Range,Point Delay,|Z|,Ls,Lp,Q
+1.000000000000E+03,1,+5.000000000000E-01,+2.000000000000E-02,Voltage,OFF,Auto,+0.000000000000E+00,
+0.000000000000E+00,OFF,Voltage,1mA,+0.000000000000E+00,+0.000000000000E+00,+0.000000000000E+00,
+0.000000000000E+00,+0.000000000000E+00
END TABLE3

BEGIN TABLE4
Frequency,Avg,OSC Voltage,OSC Current,OSC Mode,ALC,AC Range,Bias Voltage,Bias Current,Bias State,Bias Mod
e,Meas Range,Point Delay,|Z|,|Y|,G,B
+1.000000000000E+03,1,+5.000000000000E-01,+2.000000000000E-02,Voltage,OFF,Auto,+0.000000000000E+00,
+0.000000000000E+00,OFF,Voltage,1mA,+0.000000000000E+00,+0.000000000000E+00,+0.000000000000E+00,
+0.000000000000E+00,+0.000000000000E+00
END TABLE4

```

7.3 Comparator

7.3.1 Save

Operation steps below to save sorting settings:

1. When in **Comparator Table** interface, press **All Tables** on **Comparator Table** menu to enter **All Tables** menu, then click **Export All** to pop up save window.

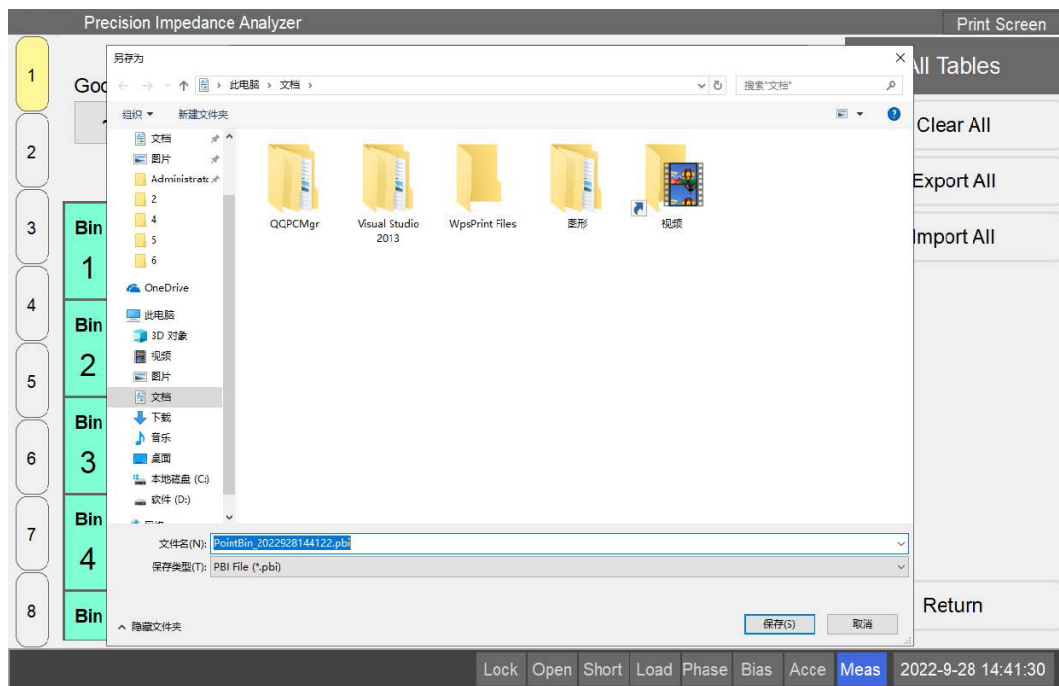

2. Locate the location to be saved in the navigation window, enter an appropriate file name, and save the file.
3. The default file format for export is .pbi.

7.3.2 Load

Operation steps below to save list settings:

1. When in the comparator setting interface, press **All Tables** on **Comparator Table** menu to enter **All Tables** menu, then click **Import All** to pop up save window.
2. Select needed file in the navigation window, and press open to load the file.

7.4Sweep

Click **Sweep** on **Point Root** menu to enter **Sweep Root** menu, then click **Save/Recall** on **Sweep Root** menu or press **Save/Recall** button on the front panel to enter **Save/Recall** menu.



7.4.1 State

Save the relevant data in a file and reload it later.

The save mode is as follows:

Save Type	Description
State Only	Only save settings of Sweep
State & Trace	Save settings and measurement data

The save data mode is as follow:

Channel/Trace	Description
Display Only	Only save relevant data currently displayed
All	Save relevant data of all channels and traces

7.4.1.1 Save

The pairs of **Save Type** and **Channel/Trace** are as follow:

1. **Save Type** is State Only and **Channel/Trace** is Display Only. That means saving only the settings of the currently displayed channels and traces.
2. **Save Type** is State Only and **Channel/Trace** is all. That means saving only the settings of all channels and traces.
3. **Save Type** is State & Trace and **Channel/Trace** is Display Only. That means saving the settings and measurement data of the currently displayed channels and traces.
4. **Save Type** is State & Trace and **Channel/Trace** is all. That means saving the settings and measurement data of all channels and traces.

Operation steps below to save state:

1. When in the sweep interface, press **Save/Recall** on the front panel to enter **Save/Recall** menu, then click **Save State** to enter **Save State** menu.
2. Select and click needed state to save settings.
3. **The specific saving method is the same as that of point measurement (See 7.1.1 for details).**

7.4.1.2 Load

The specific loading method is the same as that of point measurement (See 7.1.2 for details).

7.4.2 Channel

STB8851 allows the user to save/load the setting status of a channel separately. This function allows the user to save the state of the activated channel to one of the four positions (A-D) separately, and then load the stored settings after activating the other channel. This function is very convenient for copying status between channels. It should be noted that, unlike the state of saving the whole trace sweep, this function saves the data in the memory as a temporary file, so once the power is off or the program is closed, the stored data will be lost.

7.4.2.1 Save

Operation steps below to save channel settings:

1. When in the sweep interface, press **Channel Next** or **Channel Prev** on the front panel to switch to the channel to be saved.

2. Press **Save/Recall** on the front panel to enter **Save/Recall** menu, then click **Save Channel** to enter **Save Channel** menu.
3. Select and click needed key to save settings.

NOTE: If the key name is marked with "*", it means that there is a saved file in the save field. Click this button to prompt whether to overwrite the existing file, and click OK to save and overwrite it.

7.4.2.2 Load

Operation steps below to load channel settings:

1. When in the sweep interface, press **Channel Next** or **Channel Prev** on the front panel to switch to the channel to be loaded.
2. Press **Save/Recall** on the front panel to enter **Save/Recall** menu, then click **Recall Channel** to enter **Recall Channel** menu.
3. Select and click needed key to load settings.

7.4.2.3 Clear

Operation steps below to clear channel settings:

1. When in the sweep interface, press **Save/Recall** on the front panel to enter **Save/Recall** menu, then click **Save Channel** to enter **Save Channel** menu.
2. Click **Clear States** to clear all channel save files.

7.4.3 Trace Data

Operation steps below to save trace data:

1. When in the sweep interface, press **Channel Next** or **Channel Prev** on the front panel to switch to the channel to be saved.
2. Press **Save/Recall** on the front panel to enter **Save/Recall** menu, then click **Save Trace Data** to enter **Save Trace Data** menu.
3. Click **Scope** to select the scope of trace to save:

Scope	Description
Single	Save only the currently active trace
Channel	Save all traces in the currently active channel
Displayed	Save all visible traces in all visible channels

4. After selecting the scope, click **Save Trace Data** on **Save Trace Data** menu to pop up save window.
5. Locate the location to be saved in the navigation window, enter an appropriate file name, and save the file.

Chapter 8 System Setup

8.1 System Calibration

System calibration is the various calibrations performed on the STB8851 before the device leaves the factory, and system calibration directly affects the measurement accuracy of the STB8851. A password is required to enter the system calibration interface, and in principle, users are prohibited from entering this interface.

8.2 Language Settings

STB8851 can set different language environment according to user requirements. After setting the language, the software interface is displayed in the set language text. Currently, STB8851 supports Chinese and English settings.

Set the software language according to the following steps:

1. Press **System** on the front panel to enter the System menu.
2. Press **Language Set** to enter the Language Set menu and press the button corresponding to the language you need to set to complete the setting.

8.3 System Test

The system test is a functional test of some of the STB8851's hardware in software, and the test results are displayed on the screen.

8.3.1 Front Panel Test

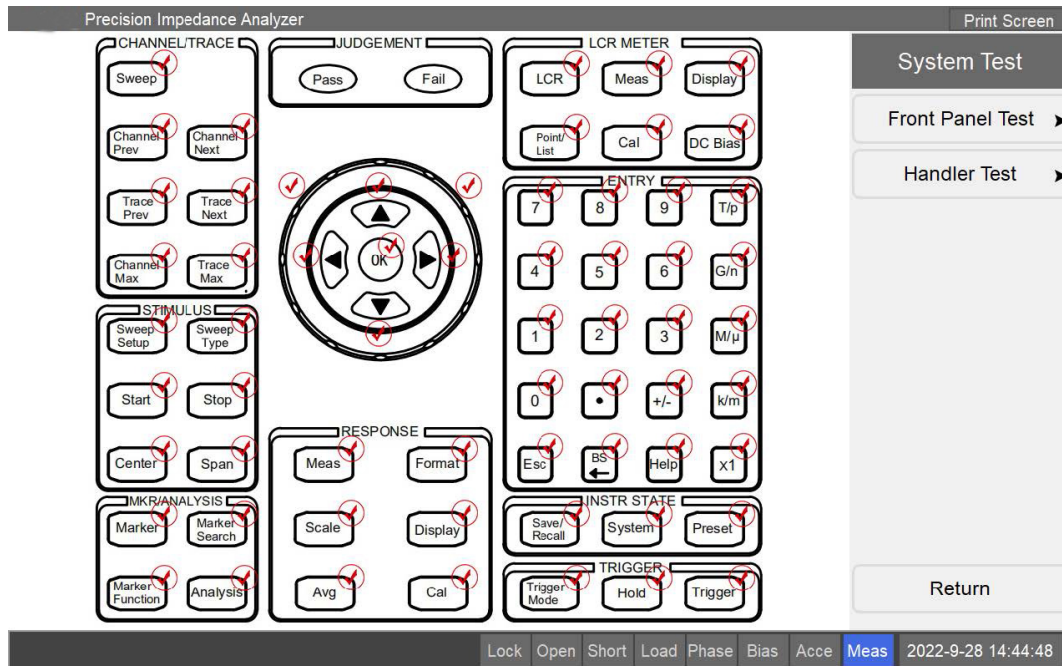

The front panel test is a test of the STB8851 front panel keys. The front panel keys are displayed graphically in this interface. When the test is performed, if the key function is normal after pressing the key, a green tick ✓ will be displayed on the upper right corner of the corresponding key graphic in this interface, indicating that the test is passed. At the same time, after entering this interface, the keys with background lights on the front can light up and turn off the background lights intermittently.

Perform the front panel test according to the following steps:

1. Press **System** on the front panel to enter the System menu.
2. Press **Test > Front Panel Test** to perform the front panel test.

8.3.2 Handler Test

The Handler test is a test of the STB8851's Handler function.

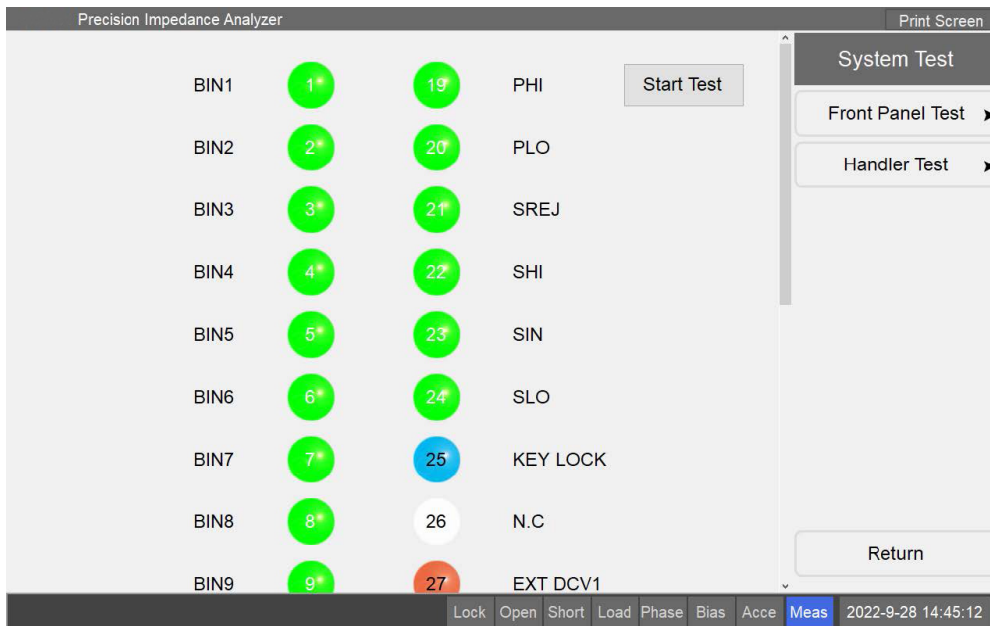

The Handler corresponding to the gray/green indicator in the interface can switch between high and low levels. When the indicator is switched from gray to green by Pressing on it, the corresponding Handler can issue a command to set the level to high; when the indicator is switched from green to gray by Pressing on it, the corresponding Handler can issue a command to set the level to low. Pressing the **Start Test** button can automatically cycle through all Handlers in order.

Enter the Handler test according to the following steps:

1. Press **System** on the front panel to enter the System menu.
2. Press **Test > Handler Test** to perform the Handler test.

8.4 Preset

You can restore the setting state of the STB8851 to its initial state. Depending on the options in the initialization settings, the instrument can be restored to the factory state or to a user-saved state.

Follow the steps below:

1. Press **System** on the front panel to enter the System menu.
2. Press **Preset** to start the preset operation.

8.5 System Information and Software Updates

The system information page displays the current instrument information of the STB8851, including product name, measurement frequency range, manufacturer, software version number, serial number, MAC address, IP address, etc., and allows for software updates.

Open the system information screen according to the following steps:

1. Press **System** on the front panel to enter the System menu.
2. Press **Info** button to open the System Information screen.
3. The system IP address, only when the LAN port is connected, is displayed with the normal setting value, otherwise the default display is 127.0.0.1.

Press **Update** link on the lower left corner to update the software. Select the software update package on the pop-up window and open it. The software is closed and updated automatically and will start automatically after the update is completed.

8.6 Misc Setup

8.6.1 GPIB Setup

Set and modify the address of the GPIB:

1. Press **System** on the front panel to enter the System menu.
2. Press **Misc Setup** to access the Misc Setup menu.
3. Press **GPIB Setup**, enter the new address in the input box and press **X1** to finish the modification.

8.6.2 Network Setup

You can set up the network parameters of the STB8851 and switch the network connection on and off. The modified settings can only take effect after the software is restarted.

1. Press **System** on the front panel to enter the System menu.
2. Press **Misc Setup** to access the Misc Setup menu.
3. Press **Network Setup** to make changes.

8.6.3 Serial Port Setup

Set the baud rate of the serial port of the STB8851.

1. Press **System** on the front panel to enter the System menu.
2. Press **Misc Setup** to access the Misc Setup menu.
3. Press **Serial Port Setup** to select and modify the baud rate.

8.6.4 Preset Setup

You can modify the preset setup of the STB8851. When the preset is performed, you can restore to

factory settings or user settings. If the user settings file does not exist, only the factory settings can be restored. It is also possible to set whether a secondary confirmation is required when the preset setup is performed:

1. Press **System** on the front panel to enter the System menu.
2. Press **Misc Setup** to access the Misc Setup menu.
3. Press **Preset Setup** to set up.

8.6.5 Startup Setup

Setting the state loading performed by the STB8851 at startup can be set to factory setting/user setting/auto setting. When set to factory settings, the system automatically loads the factory settings when powering up; when set to user settings, the system loads the user settings file (if the file exists) when powering up; when set to auto settings, the system loads the auto settings file (if the file exists) when powering up. When the startup setup is set to auto setting, the status setting file can be saved automatically every time during the software operation. If there is no relevant file when the software is started after user setting or auto setting is selected, it will be started with factory settings.

Set up according to the following steps:

1. Press **System** on the front panel to enter the System menu.
2. Press **Misc Setup** to access the Misc Setup menu.
3. Press **Start up Setup** to set up.

8.6.6 Start Form Setup

Set up the measurement interface that the STB8851 enters by default when the STB8851 starts up. It can be set to single point measurement / list measurement / trace sweep interface.

Set up according to the following steps:

1. Press **System** on the front panel to enter the System menu.
2. Press **Misc Setup** to access the Misc Setup menu.
3. Press **Start Form Setup** to make the settings.

8.6.7 Key Lock

The front panel or touch screen can be temporarily locked to prevent maloperation during remote operation.

1. Press **System** on the front panel to enter the System menu.
2. Press **Misc Setup** to access the Misc Setup menu.

3. Press **Key Lock** to set it up.

8.6.8 Handler Setup

Set up and modify the Handler output rules of STB8851.

8.6.8.1 Effective Level Setup

Set the effective output level of Handler, when set to high, the output is ON when it is high; when set to low, the output is ON when it is low.

1. Press **System** on the front panel to enter the System menu.
2. Press **Misc Setup** to access the Misc Setup menu.
3. Press **Handler Setup** to enter the Handler Setup menu.
4. Press **Affective Level** to toggle the Effective Level setup.

8.6.8.2 Signal Type Setup

Set the output signal of the Handler as a level signal or a pulse signal:

1. Press **System** on the front panel to enter the System menu.
2. Press **Misc Setup** to access the Misc Setup menu.
3. Press **Handler Setup** to enter the Handler Setup menu.
4. Press **Signal Type** to switch the Signal Type setup.

8.6.8.3 Pulse Width Setup

Set the pulse width when the output signal of Handler is a pulse signal, and the valid range of pulse width is 1ms-1000ms.

1. Press **System** on the front panel to enter the System menu.
2. Press **Misc Setup** to enter the Misc Setup menu.
3. Press **Handler Setup** to enter the Handler Setup menu.
4. Press **Pulse Width (ms)** and enter the pulse width that needs to be set up.

8.6.8.4 Supply Voltage Setup

Set the supply voltage of the Handler to Internal or External:

1. Press **System** on the front panel to enter the System menu.

2. Press **Misc Setup** to access the Misc Setup menu.
3. Press **Handler Setup** to enter the Handler Setup menu.
4. Press **Supply Voltage** to switch the Supply Voltage setup.

8.6.9 Beeper

Set whether the buzzer sounds when a front panel button or a button in the menu bar is pressed.

1. Press **System** on the front panel to enter the System menu.
2. Press **Misc Setup** to access the Misc Setup menu.
3. Press **Beeper** to switch the beeper ON/OFF status.

Chapter 9 Programming Commands

9.1 Remote Control

9.1.1 Types of Remote Control

Depending on the system controller and the interface, the user can choose the types of remote-control system shown in the following table (after starting remote control, the front panel and screen will be locked and unlocked by pressing the Help key).

System Controller	Interface	Summarize
External controller (external computer, such as the PC or workstation)	GPIB	Connecting an external controller to the STB8851 via GPIB
	LAN	Connecting an external controller to the STB8851 via LAN
	USB	Connecting an external controller to the STB8851 via USB
	RS232	Connecting an external controller to the STB8851 via RS232

9.1.1.1 GPIB Remote Control System

GPIB (General Purpose Interface Bus) is an interface standard used to connect computers to peripheral devices that conform to IEEE 488.1, IEC-625, IEEE 488.2 and JIS-C1901 international standards. The GPIB interface enables the user to control the STB8851 from an external computer. The computer sends commands and commands to the STB8851 and receives data sent from the STB8851 via GPIB.

9.1.1.2 LAN (Local Area Network) Remote Control System

The STB8851 and the external controller are connected via LAN (Local Area Network) and the STB8851 is programmed and controlled using SCPI commands after connection.

In the control system utilizing SCPI commands, communication between the external controller (client) and the STB8851 (server) is performed using the SICL-LAN protocol. Using SICL (Standard Instrument Control Program Library), the user can control the STB8851 by programming using SICL or VISA, in the UNIX environment using the C language, or in the Windows environment, the programming environment such as Visual C++ and Visual Basic language are used.

When using LAN for remote control, you need to set the network environment of the STB8851 first. Set up the network environment of the STB8851 according to the following steps:

1. Press **System** on the front panel to enter the System Setup menu.

2. Click **Misc Setup** > **Network Setup** to open the Network Setup menu
3. Click **Enable** to set the network status of the STB8851 to ON.
4. Click **Network Config** to bring up the system's Network Setup window and set the system's IP address.
5. When you have finished making changes, click **Return** and the STB8851 will pop up a dialog box prompting that the software needs to be restarted to enable the settings, click OK to restart.
6. On the device to be connected, set the IP address to the same network segment as the STB8851 and the port number to 5025, then connect the STB8851.

9.1.1.3 USB and RS232 Remote Control System

The STB8851 is controlled by programming the STB8851 through the RS232 serial port connected to the STB8851 and the external controller. The USB control system is using USB as a serial port.

Modify the baud rate of the STB8851 serial communication protocol according to the following steps:

1. Press **System** on the front panel to enter the System Setup menu.
2. Click **Misc Setup** > **Serial Port Setup** to open the Serial Port Setup menu.
3. Click the button corresponding to the baud rate to be set to complete the setting.

9.1.2 About the SCPI Commands

9.1.2.1 Type of Commands

The following two groups of commands are available for the STB8851 Commands: The STB8851-specific commands include all the measurement functions that the STB8851 has and some general-purpose functions. The commands in this group are arranged in a hierarchical structure, which is called the command tree. Each command consists of character strings (mnemonics) indicating each hierarchical level and the colon separators between the hierarchical levels.

IEEE Common Commands: Commands that relate to the generic functions defined in the IEEE 488.2 standard and are commonly available to instruments that support this standard. The commands in this group all begin with an asterisk (*) and the commands in them are not arranged in the hierarchical structure.

9.1.2.2 The Concept of Command Trees

The commands at the top of the command tree are called "root command" or simply "root". To

access lower-level commands in the tree, the user specifies a dedicated path in the DOS file system, such as the directory path. When the PC is powered on or restarted, the current path is set to the root command. The following describes changing the path setting using special characters in the message:

End-of-message symbol: The end-of-message symbol, such as the <new line> character sets the current path to the root command.

Colon: a colon between two command mnemonics lowers the level of the current path in the command tree. A colon used as the first character of a command specifies the command mnemonic that are located below the root command.

Semicolon: The semicolon does not change the current path but is used to distinguish between two commands in the same message.

9.1.2.3 Grammar of the Message

This section describes the grammar for sending program messages over the GPIB. Program messages are messages that the user sends from the external controller to the instrument for controlling the instrument. A program message consists of one or more commands and their necessary parameters.

Program Message End Symbol: A program message must end with one of the following three program message end symbols: <newline>, <^END> or <newline><^END>. <^END> indicates that the EOI on the GPIB interface is activated immediately after the previous data byte is sent. For example, the OUTPUT command on HTBasic automatically sends the end-of-message symbol when the last data byte has been sent. When programming, use '\n' (0x0a in hex) as the end symbol.

Parameters: A space (ASCII code: 32) needs to be added between the command and its first parameter. When sending several parameters in a single command, each parameter should be separated by a comma.

Messages containing multiple commands: when sending two or more commands in a single message, the commands are separated by a semicolon.

9.1.3 Programming Examples

The programming language of the programming example is c#. In the example, command is the command variable to be sent, data is the return data variable to be read, SendData is the command send function, and ReadData is the get return data function. Users can refer to the example and modify the command according to their actual situation.

9.1.3.1 Single Point Measurement

Set the measurement frequency to 1MHz, the measurement speed to 1, the measurement level to 200mV, the averaging times to 1, the AC range to auto range, the measurement parameters set to

|Z|,θ z(deg), R, X, perform one trigger and read the measurement data as follows:

```
string command = ":TRIG:SOUR BUS" + '\n';
SendData(command);
command = ":FREQ 1E6;:APER 1;:VOLT 0.2;:AVER:COUN 1;:FUNC:IMP:RANG AUTO" +
'\n';
SendData(command);
command = ":FUNC:PAR1:FORM Z; :FUNC:PAR2:FORM TZD; :FUNC:PAR3:FORM
R; :FUNC:PAR4:FORM X" + '\n';
SendData(command);
Thread.Sleep(100);
SendData("*TRG" + '\n');
string data = ReadData();
```

9.1.3.2 List Measurement

Set the number of points in the list to 10 and the frequency of each point to 1MHz, 2MHz10MHz in that order, followed by a trigger and read the measurement data:

```
string command = ":LIST:TRIG BUS" + '\n';
SendData(command);
command = ":LIST:POIN 10" + '\n';
SendData(command);
command = "";
for(int i = 0; i < 10; i++)
{
double freq = 1000000 * (i + 1);
command += ":LIST:FREQ" + (i + 1) + " " + freq;
if(i != 9) command += ";";
else command += '\n';
}
SendData(command);
Thread.Sleep(100);
SendData("*TRG" + '\n');
```

```
string data = ReadData();
```

9.1.3.3 Trace Sweep

The system is initialized, and then the number of trace points for channel 1 is set to 100, the start frequency to 100 kHz, the end frequency to 1 MHz, the measurement speed to 3, and the number of single point averages to 1. Then a trigger is performed, and the R and X values for each measurement point are read after completing one measurement cycle:

```
string command = ":SYST:PRES" + '\n';  
  
SendData(command);  
  
Thread.Sleep(500);  
  
command = ":TRIG:SOUR BUS" + '\n';  
  
SendData(command);  
  
command = ":SENS1:SWE:POIN 100;;SENS1:APER 3;;INIT1:CONT 1" + '\n';  
  
SendData(command);  
  
Thread.Sleep(50);  
  
command = ":SENS1:FREQ:STAR 1E5;;SENS1:FREQ:STOP 1E6" + '\n';  
  
SendData(command);  
  
Thread.Sleep(50);  
  
command = ":TRIG:SING" + '\n';  
  
Thread.Sleep(100);  
  
string data = "";  
  
while(data != "+1\n")  
{  
  
SendData("*OPC?" + '\n');  
  
data = ReadData();  
  
}  
  
command = ":CALC1:DATA:RDAT?" + '\n'  
  
SendData(command);  
  
data = ReadData();
```

9.2 Command Reference

9.2.1 Symbolic Conventions

This section describes the symbolic conventions of the commands in this chapter and how the command reading should be performed.

9.2.1.1 Command Type

The section headed "Types of Commands" describes the types of commands which there are three main types:

Command/Query: can be used to set parameters or to query them.

Command: only be used to set parameters.

Query: only be used to query parameters.

9.2.1.2 Syntax

The section headed "Syntax" is the syntax used to send commands from the external controller to the STB8851. The syntax consists of a command part and a parameter part. These two parts are separated by the space.

If there are several parameters, a comma is used as a separator between adjacent parameters. Ellipsis (...) between commas indicates omitted parameters. For example, < number 1 >, ..., < number 4 > denotes four parameters, i.e., < number 1 >, < number 2 >, < number 3 >, and < number 4 >.

String-type parameters, < string >, < string1 >, etc. Also, < block > represents data in block format data.

The user can omit the lowercase letters in syntax. For example, " :BIAS:CURRent " can be shortened as: "BIAS:CURR".

The definition of the symbols used in the syntax is shown below:

<> The characters in the angle brackets are the necessary parameters for sending the command.

[] The part in the square brackets can be omitted.

{ } The characters in the curly brackets indicate that the user must select one of the bracketed characters. Each character option is separated by a vertical bar {}.

For example, "BIAS:CURR 0.001", ":BIAS:CURRENT:LEVEL 1E-3", etc. can be used in the following syntax:

Syntax: BIAS:CURRent[:LEVel] <numeric>

9.2.1.3 Description

The section headed "Description" describes the use of the command or the operation performed by the command.

9.2.1.4 Parameters

The section titled "Parameters" describes the necessary parameters when sending the command. When the parameter is a numeric type or string type in <>, the definition of the parameter, the allowable value range, the preset (factory-set) value, etc. are given, and when the parameter is a selection type in { }, the description of each selection item is given.

9.2.1.5 Examples

A brief example is provided to the usage of the command

9.2.1.6 Query Response

The section titled "Query Response" describes the format of the reading return data when the command contains a query.

Each parameter that can be read is contained in curly brackets { }, and if the curly brackets contain multiple parameters separated by vertical bars (|) at points, only one parameter can be read at a time.

When several parameters are read, they are separated by a comma (,). Ellipsis (...) between the commas indicates omitted parameters. For example, < number 1 >, ..., < number 4 > denotes four parameters, i.e., < number 1 >, < number 2 >, < number 3 >, and < number 4 >.

<newline><^END> represents the end of the program message.

9.2.1.7 Related Keys

The section titled "Related Keys" indicates the operation of the front panel keys and menu buttons that have the same effect as this command.

9.2.2 Commonly Used Standard Commands

9.2.2.1 *IDN

Command Type: Query

Syntax: *IDN?

Description: Get product information (manufacturer, model number, product serial number, etc.) of the STB8851

Query Response: {text 1}, {text 2}, {text 3} <newline><^END>

Text 1: Manufacturer, the default display is "Saluki Technoloy Inc."

Text 2: Product name and model number, the default product name is " STB8851

" Text 3: Product serial number

Related keys: [System](#) > [Info](#)

9.2.2.2 *OPC

Command Type: Query

Syntax: *OPC?

Description: Read "+1" after all operations are complete, otherwise read "0"

Query Response: {+1|0} < newline><^END>

Related keys: None

9.2.2.3 *RST

Command Type: Command

Syntax: *RST

Description: Preset the instrument to the factory state, this command is different from the command: SYSTem:PREset

Related keys: [Preset](#)

9.2.2.4 *TRG

Command Type: Command

Syntax: *TRG

Description: Perform a trigger. When the current measurement mode is point measurement or list sweep, the measurement result will be returned at the end of the measurement; when the current measurement is sweep mode, the trigger source is required to be set to Bus.

Related keys: [Trigger](#)

9.2.3 Public Commands

Public commands can be responded to at all measurement interfaces.

9.2.3.1 :CORRECTION

◆ :CORR:CLE

Command Type: Command

Syntax:

:CORRection:CLEar

Description: Initialize data for all user calibration points

:CORR:LOAD

Command Type: Command

Syntax: [:SENSe]:CORRection:LOAD[:EXECute]

Description: Perform load calibration for all frequency points

Related Keys: **Cal** > **Load** > **ALL Frequency Load**

◆ :CORR:LOAD:{R|C|L}

Command Type: Command/Query

Syntax:

[:SENSe]:CORRection:LOAD: {R|C|L} <number>

[:SENSe]:CORRection:LOAD: {R|C|L}?

Description: Set or query the resistance/capacitance/inductance setting value of the load calibration

Query Response: {< number>} <newline><^END>

Related keys: **Cal** > **Load** > **Load Resistance / Load Capacitance / Load Inductor**

◆ :CORR:LOAD:STAT

Command Type: Command/Query

Syntax:

[[:SENSe]:CORRection:LOAD:STATe {ON|OFF|1|0}

[[:SENSe]:CORRection:LOAD:STATe?

Description: Set or query the on-off state of the user load calibration

Parameters:

Parameter	Selection Option
Description	Load calibration switch
Data Type	Boolean type (Boolean)
Range	ON OFF 1 0
Preset Value	ON

Examples:

Turn on the load calibration:

:CORR:LOAD:STAT ON

Query the load calibration open state:

:CORR:LOAD:STAT?

Query Response: {1|0}< newline><^END>

Related keys: **Cal** > **Load**

◆ :CORR:LOAD:TYPE

Command Type: Command/Query

Syntax:

[[:SENSe]:CORRection:LOAD:TYPE

{RX|CPD|CPQ|CPG|CPRP|CSD|CSQ|CSRS|LPD|LPQ|LPG |LPRP|LSD|LSQ|LSRS|ZTD|ZTR|GB|YTD|YTR}

[[:SENSe]:CORRection:LOAD:TYPE?

Description: Set and query the parameters used for load calibration

Parameters:

Parameter	Selection Option
Description	Load calibration parameter
Data Type	Character string type (String)

Range	RX: R~X CPD: Cp~D CPQ: Cp~Q CPG: Cp~G CPRP: Cp~Rp CSD: Cs~D CSQ: Cs~Q CSRS: Cs~Rs LPD: Lp~D LPQ: Lp~Q LPG: Lp~G LPRP: Lp~Rp LSD: Ls~D LSQ: Ls~Q LSRS: Ls~Rs ZTD: Z ~ θ z(deg) ZTR: Z ~ θ z(rad) GB: G~B YTD: Y ~ θ y(deg) YTR: Y ~ θ y(rad)
Preset Value	RX

Examples:

Set the load calibration parameter to Cp~D:

```
:CORR:LOAD:TYPE CPD
```

Query the load calibration parameter:

```
:CORR:LOAD:TYPE?
```

Query Response:

```
{RX|CPD|CPQ|CPG|CPRP|CSD|CSQ|CSRS|LPD|LPQ|LPG|LPRP|LSD|LSQ|LSRS|
ZTD|ZTR|GB|YTD|YTR}< newline><^END>
```

Related keys: **Cal** > **Load Type**

◆ :CORR:OPEN

Command Type: Command

Syntax: [:SENSe]:CORRection:OPEN[:EXECute]

Description: Open clear for all frequency points

Related keys: **Cal** > **Open** > **All Frequency Clear**

◆ :CORR:OPEN:STAT

Command Type: Command/Query

Syntax:

[[:SENSe]:CORRection:OPEN:STATe {ON|OFF|1|0}

[[:SENSe]:CORRection:OPEN:STATe?

Description: Set and query the on-off state of the user open calibration

Parameters:

Parameter	Selection Option
Description	Open calibration switch
Data Type	Boolean type (Boolean)
Range	ON OFF 1 0
Preset Value	ON

Examples:

Turn on the open calibration:

:CORR:OPEN:STAT ON

Query the open calibration open state:

:CORR:OPEN:STAT?

Query Response: {1|0}< newline><^END>

Related keys: Cal > Open

◆ :CORR:SHOR

Command Type: Command

Syntax: [[:SENSe]:CORRection:SHORT[:EXECute]

Description: Short clear for all frequency points

Related keys: Cal > Short > All Frequency Clear

◆ :CORR:SHOR:STAT

Command Type: Command/Query

Syntax:

[[:SENSe]:CORRection:SHORt:STATe {ON|OFF|1|0}

[[:SENSe]:CORRection:SHORt:STATe?

Description: Set and query the on-off state of the user short calibration

Parameters:

Parameter	Selection Option
Description	Short calibration switch
Data Type	Boolean type (Boolean)
Range	ON OFF 1 0
Preset Value	ON

Examples:

Turn on the short calibration:

:CORR:SHOR:STAT ON

Query the short calibration open state:

:CORR:SHOR:STAT?

Query Response: {1|0}< newline><^END>

Related keys: Cal > Short

◆ :CORR:SPOT{1-20}:FREQ

Command Type: Command/Query

Syntax:

[[:SENSe]:CORRection:SPOT{1-20}:FREQ < number >

[[:SENSe]:CORRection:SPOT{1-20}:FREQ?

Description: Query and set the frequency of the specified user calibration point

Parameters:

Parameter	Numerical value
Description	Calibration point frequency
Data Type	Double precision type (double)
Range	10Hz - 130MHz
Preset Value	1000Hz

Examples:

Set the frequency of point 1 to 1MHz:

:CORR:SPOT1:FREQ 1M

Query the frequency of point 2:

:CORR:SPOT2:FREQ?

Query Response: {< number>}<newline><^END>

◆ :CORR:SPOT{1-20}:LOAD

Command Type: Command

Syntax: [:SENSe]:CORRection:SPOT{1-20}:LOAD[:EXECute]

Description: Perform the load calibration for the specified user calibration point

◆ :CORR:SPOT{1-20}:LOAD:STAN

Command Type: Command/Query

Syntax:

[:SENSe]:CORRection:SPOT{1-20}:LOAD:STANdard <number1>,<number2>

[:SENSe]:CORRection:SPOT{1-20}:LOAD:STANdard?

Description: Set and query the load reference value of the specified user calibration point

Parameters:

Parameters	< Number 1 >	< Number 2 >
Description	Load reference value 1	Load reference value 2
Data Type	Double precision type (double)	Double precision type (double)
Range	-1E15 - 1E15	-1E15 - 1E15
Preset Value	0	0
Unit	Depends on load parameter settings	Depends on load parameter settings

Examples:

Set the LOAD reference value of point 1:

:CORR:SPOT1:LOAD:STAN 1E6,1E6

Query the LOAD reference value of point 2:

:CORR:SPOT2:LOAD:STAN?

Query Response: {< number1>, < number2> }<newline><^END>

The parameters of the return value depend on the set load parameters

◆ :CORR:SPOT{1-20}:OPEN

Command Type: Command

Syntax:

[[:SENSe]:CORRection:SPOT{1-20}:OPEN[:EXECute]

Description: Perform open circuit clear for the specified user calibration point

◆ :CORR:SPOT{1-20}:SHOR

Command Type: Command

Syntax:

[[:SENSe]:CORRection:SPOT{1-20}:SHORT[:EXECute]

Description: Perform short circuit clear for the specified user calibration point

◆ :CORR:SPOT{1-20}:STAT

[[:SENSe]:CORRection:SPOT{1-20}:STATe {ON|OFF|1|0}

[[:SENSe]:CORRection:SPOT{1-20}:STATe?

Description: Set and query the on-off state of the specified user calibration point

Parameters:

Parameter	Selection Option
Description	User calibration point switch
Data Type	Boolean type (Boolean)
Range	ON OFF 1 0
Preset Value	ON

Examples:

Turn on the point 1 switch:

:CORR:SPOT1:STAT ON

Query the on-off state of point 2:

:CORR:SPOT2:STAT?

Query Response: {1|0}< newline><^END>

◆ :CORR:USE:DATA?

Command Type: Query

Syntax: [:SENSe]:CORRection:USE:DATA?

Description: Query the calibration data of all user calibration points

Query Response: {< number 1> },{< number 1> },...,{< number 120> }<newline><^END>

A total of 20 user calibration points is returned for a total of 120 data, in the order of open circuit calibration data G, open circuit calibration data Cp, short circuit calibration data R, short circuit calibration data Ls, load calibration data 1, load calibration data 2. The type of load calibration data depends on the parameters that have been set for the load calibration.

◆ :CORR2:COLL:ACQ:LOAD

Command Type: Command

Syntax: [:SENSe]:CORRection:COLLect:ACQuire:LOAD

Description: Perform load calibration for all frequency points

Related Keys: Cal > Load > All Frequency Load

◆ :CORR2:COLL:ACQ:OPEN

Command Type: Command

Syntax: [:SENSe]:CORRection:COLLect:ACQuire:OPEN

Description: Perform open circuit clear for all frequency points

Related keys: Cal > Open > All Frequency Clear

◆ :CORR2:COLL:ACQ:SHOR

Command Type: Command

Syntax: [:SENSe]:CORRection:COLLect:ACQuire:SHORt

Description: Perform short circuit clear for all frequency points

Related keys: Cal > Short > All Frequency Clear

◆ :CORR2:LOAD

Command Type: Command/Query

Syntax:

[[:SENSe]:CORRection2:LOAD {ON|OFF|1|0}

[[:SENSe]:CORRection2:LOAD?

Description: Set and query the on-off state of the user load calibration

Parameters:

Parameters	Selection Option
Description	Load calibration switch
Data Type	Boolean type (Boolean)
Range	ON OFF 1 0
Preset Value	ON

Examples:

Turn on the load calibration:

:CORR2:LOAD ON

Query the load calibration open state:

:CORR2:LOAD?

Query Response: {1|0}< newline><^END>

Related keys: Cal > Load

◆ :CORR2:OPEN

Command Type: Command/Query

Syntax:

[[:SENSe]:CORRection2:OPEN {ON|OFF|1|0}

[[:SENSe]:CORRection2:OPEN?

Description: Set and query the on-off state of the user open calibration

Parameters:

Parameter	Selection Option
Description	Open calibration switch

Data Type	Boolean type (Boolean)
Range	ON OFF 1 0
Preset Value	ON

Examples:

Turn on the open calibration:

:CORR2:OPEN ON

Query the open calibration open state:

:CORR2:OPEN?

Query Response: {1|0}< newline><^END>

Related keys: Cal > Open

◆ :CORR2:SHOR

Command Type: Command/Query

Syntax:

[:SENSe]:CORRection2:SHORt {ON|OFF|1|0}

[:SENSe]:CORRection2:SHORt?

Description: Set and query the on-off state of the user short calibration

Parameters:

Parameter	Selection Option
Description	Short calibration switch
Data Type	Boolean type (Boolean)
Range	ON OFF 1 0
Preset Value	ON

Examples:

Turn on the short calibration:

:CORR2:SHOR ON

Query the short calibration open state:

:CORR2:SHOR?

Query Response: {1|0}< newline><^END>

Related keys: Cal > Short

9.2.3.2 :DISPLAY

:DISP:CCL

Command Type: Command

Syntax:

:DISPlay:CClear

Description: Clear the warning message at the bottom of the screen

9.2.3.3 :SYSTEM

◆ :SYST:KLOC:KBD

Command Type: Command/Query

Syntax:

:SYSTem:KLOCK:KBD {ON|OFF|1|0}

:SYSTem:KLOCK:KBD?

Description: Set or query whether the front panel is disabled

Parameters:

Parameter	Selection Option
Description	Front panel lock switch
Data Type	Boolean type (Boolean)
Range	ON OFF 1 0
Preset Value	OFF

Examples:

Lock the front panel:

:SYST:KLOC:KBD ON

Query front panel lock state:

:SYST:KLOC:KBD?

Query Response: {1|0}< newline><^END>

Related keys: **System** > **Misc Setup** > **Key Lock** > **Front Panel Lock**

◆ **:SYST:KLOC:MOUS**

Command Type: Command/Query

Syntax:

:SYSTem:KLOCK:MOUSE {ON|OFF|1|0}

:SYSTem:KLOCK:MOUSE?

Description: Set or query whether the touch screen is disabled

Parameters:

Parameter	Selection Option
Description	Touch screen lock switch
Data Type	Boolean type (Boolean)
Range	ON OFF 1 0
Preset Value	OFF

Examples:

Lock the touch screen:

:SYST:KLOC:MOUS ON

Query the touch screen lock state:

:SYST:KLOC:MOUS?

Query Response: {1|0}< newline><^END>

Related keys: **System** > **Misc Setup** > **Key Lock** > **Screen Lock**

◆ **:SYST:POFF**

Command Type: Command

Syntax:

:SYSTem:POFF

Description: Turn off the STB8851

program Related keys: **System** > **Exit**

Application

◆ :SYST:PRES

Command Type: Command

Syntax:

:SYSTem:PRESet

Description: When the current measurement is in sweep mode, preset the STB8851 to the factory setting state, at this time the command differs from *RST in that the trigger mode of channel 1 will be set to continuous mode automatically after the completion; when the current measurement is point measurement or list measurement, restore the instrument to the factory setting and return to the main page of point measurement.

◆ :SYST:UPR

Command Type: Command

Syntax:

:SYSTem:UReset

Description: Preset the STB8851 to the user settings, or return an error if the user settings does not exist
file

9.2.4 Point Measurement and List Command

This section introduces the commands for point measurement and List sweep. Only if the current page belongs to point measurement or list sweep (or its related setup screen), inputting commands in this section will take effect

9.2.4.1 :AMPL

:AMPL:ALC

Command Type: Command/Query

Syntax:

:AMPLitude:ALC {ON|OFF|1|0}

:AMPLitude:ALC?

Description: Set or query the ALC (Automatic Level Control) state of the point measurement

Parameters:

Parameter	Selection Option
Description	ALC switch
Data Type	Boolean type

	(Boolean)
Range	ON OFF 1 0
Preset Value	OFF

Examples:

Set the ALC to ON: :AMPL:ALC ON

Query the ALC state: :AMPL:ALC?

Query Response: {1|0}< newline><^END>

Related keys: Meas Setup > OSC Level > ALC > ALC Control

9.2.4.2 :APER

:APER

Command Type: Command/Query

Syntax:

:APERture {1|2|3|4|5}

:aperture?

Description: Set and query the point measurement speed

Parameters:

Parameter	Selection Option
Description	Measurement speed
Data Type	Numeric type (Integer)
Range	1 2 3 4 5
Preset Value	3

Examples:

Set the measurement speed to 1:

:APER 1

Query the point measurement speed:

:APER?

Query Response: {1|2|3|4|5}< newline><^END>

Related keys: Meas Setup > Meas Time

9.2.4.3 :AVER:COUN

Command Type: Command/Query

Syntax:

:AVERage:COUNt < number >

:average:COUNt?

Description: Set and query the point averaging count

Parameters:

Parameter	Numerical value
Description	Averaging factor
Data Type	Numeric type (Integer)
Range	1 – 999
Preset Value	1

Examples:

Set the averaging factor to 5:

:AVER:COUN 5

Query the averaging factor:

:AVER:COUN?

Query Response: {< number>}<newline><^END>

Related keys: Meas Setup > Avg Count

9.2.4.4 BIAS

◆ :BIAS:CURR

Command Type: Command/Query

Syntax:

:BIAS:CURRent < number >

:BIAS:CURRent?

Description: Set or query the DC bias current. The setting does not mean that the DC bias is turned on.

Parameters:

Parameter	Numerical value
-----------	-----------------

Description	DC bias current
Data Type	Double precision type (double)
Range	-0.1 - 0.1
Unit	A
Preset Value	0

Examples:

Set the bias current to 0.1A:

:BIAS:CURREN 0.1

Query the bias current:

:BIAS:CURREN?

Query Response: {< number> }<newline><^END>

Related keys: Meas Setup > DC Bias > Current Level

◆ :BIAS:MODE

Command Type: Command/Query

Syntax:

:BIAS:MODE {VOLTage|CURRENt}

:BIAS:MODE?

Description: Set or query the point DC bias mode. The setting does not mean that the DC bias is turned on.

Parameters:

Parameter	Selection Option
Description	DC bias mode
Data Type	Character string type (String)
Range	VOLT: Voltage mode CURREN: Current Mode
Preset Value	VOLT

Examples:

Set the DC bias mode to voltage mode:

:BIAS:MODE VOLT

Query the DC bias mode:

:BIAS:MODE?

Query Response: {VOLT|CURR}< newline><^END>

Related keys: Meas Setup > DC Bias > DC Bias Mode

◆ :BIAS:RANG

Command Type: Command/Query

Syntax:

:BIAS:RANGe {M1|M10|M100}

:BIAS:RANGe?

Description: Set or query the DC bias range. The setting does not mean that the DC bias is turned on.

Parameters:

Parameter	Selection Option
Description	DC bias range
Data Type	Character string type (String)
Range	M1: 1mA M10: 10mA M100: 100mA
Preset Value	M1

Examples:

Set the DC bias range to 1mA:

:BIAS:RANG M1

Query the DC bias range:

:BIAS:RANG?

Query Response: {M1|M10|M100}< newline><^END>

Related keys: Meas Setup > DC Bias > Meas Range

◆ :BIAS:STAT

Command Type: Command/Query

Syntax:

:BIAS:STATe {ON|OFF|1|0}

:BIAS:STATe?

Description: Set or query the on-off state of the DC bias

Parameters:

Parameter	Selection Option
Description	DC Bias switch
Data Type	Boolean type (Boolean)
Range	ON OFF 1 0
Preset Value	OFF

Examples:

Turn on the DC bias:

:BIAS:STAT ON

Query the on-off state of the DC bias:

:BIAS:STAT?

Query Response: {1|0}< newline><^END>

Related keys: Meas Setup > DC Bias > DC Bias State

◆ :BIAS:VOLT

Command Type: Command/Query

Syntax:

:BIAS:VOLTage < number >

:BIAS:VOLTage?

Description: Set or query the DC bias voltage. The setting does not mean that the DC bias is turned on.

Parameters:

Parameter	Numerical Value
Description	DC bias voltage
Data Type	Double precision type (double)
Range	-40 - 40
Unit	V
Preset Value	0

Examples:

Set the bias voltage to 1V:

:BIAS:VOLT 1

Query the bias voltage:

:BIAS:VOLT?

Query Response: {< number>}<newline><^END>

Related keys: Meas Setup > DC Bias > Voltage Level

9.2.4.5 COMPATATOR

◆ :COMP

Command Type: Command/Query

Syntax:

:COMParator[::STATe] {ON|OFF|1|0}

:COMParator[::STATe]?

Description: Set or query the point comparator state

Parameters:

Parameter	Selection Option
Description	Comparator state
Data Type	Boolean type (Boolean)
Range	ON OFF 1 0
Preset Value	OFF

Examples:

Turn on the point measurement comparator:

:COMP ON

Query the status of the point measurement comparator:

:COMP?

Query Response: {1|0}< newline><^END>

Related keys: Comparator > Comparator State

◆ :COMP:BIN{1-9}

Command Type: Command/Query

Syntax:

:COMParator:BIN{ 1|2|3|4|5|6|8|9} [::STATe] {ON|OFF|1|0}

:COMParator:BIN{ 1|2|3|4|5|6|8|9} [::STATe]?

Description: Set or query the BIN (1-9) state in the point comparator

Parameters:

Parameter	Selection Option
Description	BIN state
Data Type	Boolean type (Boolean)
Range	ON OFF 1 0
Preset Value	OFF

Examples:

Turn on the BIN1:

:COMP:BIN1 ON

Query the BIN2 on-off state:

:COMP:BIN2?

Query Response: {1|0}< newline><^END>

Related keys: [Comparator](#) > [Edit Comptr Table](#) > [BIN](#) > [State](#)

◆ :COMP:BIN{ 1-9}:COND{ 1-4}:LIM

Command Type: Command/Query

Syntax:

:COMParator:BIN{ 1|2|3|4|5|6|7|8|9}:CONDition{ 1|2|3|4}:LIMit <number1>,<number2>

:COMParator:BIN{ 1|2|3|4|5|6|7|8|9}:CONDition{ 1|2|3|4}:LIMit?

Description: Set and query the limit line of each BIN table condition (1-4) of each BIN (1-9) in the point comparator. The limit line contains upper and lower limit values.

Parameters:

Parameter	< Number 1 >	< Number 2 >
Description	Lower value	Upper value
Data Type	Double precision type (double)	Double precision type (double)

Range	-1E9 - 1E9	-1E9 - 1E9
Preset Value	0	0
Unit	Depend on BIN parameters	Depend on BIN parameters

Examples:

Set the upper limit of BIN1 condition 1 to 2k and the lower limit to 1k:

:COMP:BIN1:COND1:LIM 1E3,2E3

Query the upper and lower limits of BIN2 condition 2:

:COMP:BIN2:COND2:LIM?

Query Response: {< number1> }, {< number2>}<newline><^END>

Related keys: [Comparator](#) > [Edit Comptr Table](#) > [BIN](#) > [Upper / Lower](#)

◆ :COMP:BIN{1-9}:COND{1-4}:LTYP

Command Type: Command/Query

Syntax:

:COMParator:BIN{1|2|3|4|5|6|7|8|9}:CONDition{1|2|3|4}:LTYPe {IN|OUT|ALL}

:COMParator:BIN{1|2|3|4|5|6|7|8|9}:CONDition{1|2|3|4}:LTYPe?

Description: Set and query the limit line type of each BIN table condition (1-4) of each BIN (1-9) in the point comparator

Parameters:

Parameter	Selection Option
Description	Limit line type
Data Type	Character string type (String)
Range	IN OUT ALL
Preset Value	ALL

Examples:

Set the limit line type of BIN1 condition 1 to IN:

:COMP:BIN1:COND1:LTYP IN

Query the limit line type of BIN2 condition 2:

:COMP:BIN2:COND2:LTYP?

Query Response: {IN|OUT|ALL}< newline><^END>

Related keys: **Comparator** > **Edit Comptr Table** > **BIN** > **In/Out**

◆ :COMP:CLE

Command Type: Command

Syntax: :COMParator:CLEar

Description: Restore all point measurement comparator table to their initial values

Related keys: **Comparator** > **Edit Comptr Table** > **All Tables** > **Clear All**

◆ :COMP:COND{1-4}:MODE

Command Type: Command/Query

Syntax:

:COMParator:CONDition{1|2|3|4}:MODE {OFF|DEV|PCNT|PDEV}

:COMParator:CONDition{1|2|3|4}:MODE?

Description: Set and query the data math of the point measurement comparator table condition (1-4)

Parameters:

Parameter	Selection Option
Description	Comparator data math
Data Type	Character string type (String)
Range	OFF: Off DEV: Deviation PCNT: Percent PDEV: Deviation percent
Preset Value	OFF

Examples:

Set the data math of condition 1 to Deviation:

:COMP:COND1:MODE DEV

Query the data math of condition 2:

:COMP:COND2:MODE?

Query Response: {OFF|DEV|PCNT|PDEV }<newline><^END>

Related keys: **Comparator** > **Edit Comptr Table** > **Mode**

◆ :COMP:COND{1-4}:NOM

Command Type: Command/Query

Syntax:

:COMParator:CONDition{1|2|3|4}:NOMinal < number >

:COMParator:CONDition{1|2|3|4}:NOMinal?

Description: Set or query the reference value of the point measurement comparator table condition (1-4)

Parameters:

Parameter	Numerical Value
Description	Comparator reference value
Data Type	Double precision type (double)
Range	-1E9 - 1E9
Preset Value	0

Examples:

Set the reference value of condition 1 to 1000:

:COMP:COND1:NOM 1E3

Query the reference value of condition 2:

:COMP:COND2:NOM?

Query Response: {< number>}<newline><^END>

Related keys: [Comparator](#) > [Edit Comptr Table](#) > [Reference](#)

◆ :COMP:COND{1-4}:PAR

Command Type: Command/Query

Syntax:

:COMParator:CONDition{1|2|3|4}:PARAmeter{Z|Y|TZR|TZD|TYR|TYD|RS|RP|LS|LP|CS|CP|R|G|X|B|Q|D}

:COMParator:CONDition{1|2|3|4}:PARAmeter?

Description: Set or query the measurement parameters of the point measurement comparator table condition (1-4)

Parameters:

Parameter	Selection Option
Description	Comparator measurement parameter
Data Type	Character string type (String)
Range	Z: Z Y: Y TZR.θ z(rad) TZD.θ z(deg) TYR.θ y(rad) TYD.θ y(deg) RS: Rs RP: Rp LS: Ls LP: Lp CS: Cs CP: Cp R: R G: G X: X B: B Q: Q D: D
Preset Value	Z

Examples:

Set the parameters of condition 1 to R:

:COMP:COND1:PAR R

Query the parameters of condition 2:

:COMP:COND2:PAR?

Query Response: {Z|Y|TZR|TZD|TYR|TYD|RS|RP|LS|LP|CS|CP|R|G|X|B|Q|D}<newline><^END>

Related keys: [Comparator](#) > [Edit Comptr Table](#) > [Parameter](#)

◆ :COMP:COND{1-4}:SW

Command Type: Command/Query

Syntax:

:COMParator:CONDition{1|2|3|4}:SWitch {ON|OFF|1|0}

:COMParator:CONDition{1|2|3|4}: SWitch?

Description: Set or query the on-off state of the point measurement comparator table condition (1-4)

Parameters:

Parameter	Selection Option
Description	Comparator condition switch
Data Type	Boolean type (Boolean)
Range	ON OFF 1 0
Preset Value	ON

Examples:

Turn on the setting conditon 1:

:COMP:COND1:SW ON

Query the on-off state of the setting condition 2:

:COMP:COND2:SW?

Query Response: {1|0}< newline><^END>

Related keys: [Comparator](#) > [Edit Comptr Table](#) > [State](#)

◆ :COMP:COUN

Command Type: Command/Query

Syntax:

:COMParator:COUNt[::STAtE] {ON|OFF|1|0}

:COMParator:COUNt[::STAtE]?

Description: Set or query the open state of the point measurement comparator count

Parameters:

Parameter	Selection Option
Description	Comparator count state
Data Type	Boolean type (Boolean)
Range	ON OFF 1 0
Preset Value	ON

Examples:

Turn on the comparator count:

:COMP:COUN ON

Query the on-off state of the comparator count:

:COMP:COUN?

Query Response: {1|0}< newline><^END>

Related keys: [Comparator](#) > [Bin Count](#)

◆ :COMP:COUN:CLE

Command Type: Command

Syntax: :COMParator:COUNt:CLEar

Description: Clear the current point measurement comparator count

Related keys: [Comparator](#) > [Clear Bin Count](#)

◆ :COMP:DATA:BCO

Command Type: Query

Syntax: :COMParator:DATA:BCOunt?

Description: Query each BIN count of the comparator in the point measurement

Query Response: {< number 1>}, {< number 2>},{< number 3>}, {< number 4>},{< number 5>}, {< number 6>},{< number 7>}, {< number 8>},{< number 9>}, {< number 10>}<newline><^END>

Number 1 to number 9 represent the Bin count of the BIN 1 - BIN 9, and the number 10 represents counts that failed to be sorted into any BIN (Out of Good).

◆ :COMP:DATA:BIN

Command Type: Query

Syntax: :COMParator:DATA:BIN?

Description: Query the most recent Bin result

Query Response: {0|1|2|3|4|5|6|7|8|9|10}< newline><^END>

In the command, 0 indicates that the BIN cannot be sorted into any BIN, 1-9 indicates the corresponding bin sequence number, and 10 indicates the bin failure caused by measurement errors

(usually Overload).

◆ :COMP:OGB

Command Type: Command/Query

Syntax:

:COMParator:OGBins < number >

:COMParator:OGBins?

Description: Set or query the number of qualified BINs of the point measurement comparator

Parameters:

Parameter	Numerical Value
Description	Comparator number of good bins
Data Type	Numeric type (Integer)
Range	1 - 9
Preset Value	9

Examples:

Set the BIN1-BIN3 as qualified BINs:

:COMP:OGB 3

Query the number of qualified BINs:

:COMP:OGB?

Query Response: {< number>}<newline><^END>

Related keys: [Comparator](#) > [Edit Compr Table](#) > [Good Bins](#)

9.2.4.6 CURRENT

:CURR

Command Type: Command/Query

Syntax:

:CURRent < number >

:CURRent?

Description: Set and query the current of the point measurement signal source and set the level mode to current mode automatically after setting the current.

Parameters:

Parameter	Numerical Value
Description	Signal source current
Data Type	Double precision type (double)
Range	0.0002 - 0.02
Preset Value	0.02
Unit	A

Examples:

Set the current to 10mA:

:CURR 0.01

Query the current value:

:CURR?

Query Response: {< number>}<newline><^END>

Related keys: Meas Setup > OSC Level > Current Level

9.2.4.7 DISPLAY

:DISP:PAGE

Command Type: Command/Query

Syntax:

:DISPlay:PAGE

{MEASurement|LIST|STIMulus|SWEEp|CAL|COMParator|PoinTCOMparator}

:DISPlay:PAGE?

Description: Open the specified page, or query the currently displayed page

Parameters:

Parameter	Selection Option
Description	Measuring Fixture
Data Type	Character string type (String)
Range	MEASurement: Point measurement interface LIST: List measurement interface STIMulus: Stimulus interface SWEEp: Sweep measurement interface CAL: User Calibration Interface

	COMParator: Comparator interface PoinTCOMparator: Point measurement comparator interface
--	---

Examples:

Open the list measurement interface:

:DISP:PAGE LIST

Query Response: {MEAS|LIST|STIM|SWEE|CAL|COMP|PTCO}< newline><^END>

9.2.4.8 FETCH

◆ :FETC

Command Type: Query

Syntax: :FETCh[:IMPedance]?

Description: Query the current measurement results of the point measurement/list sweep

Query Response:

Point: {<number1>}, {<number2>}, {<number3>}, {<number 4>}, {1|0},
{0|1|2|3|4|5|6|7|8|9|10} <newline> <^END>

List: {< point 1 parameter 1> },{< point 1 parameter 2> },{< point 1 parameter 3> },{< point 1
parameter 4> },..., {< point n parameter 1> },{< point n parameter 2> },{< point n parameter
3> },{< point n parameter 4>},{1|0},{0|1|2|3|4|5|6|7|8|9|10}<newline><^END>

In the response to the point measurement, number 1--number 4 are the measured values of the 4 parameters of the current page;

In the response to the list sweep, n is the number of measurement points in the list, and the first 4*n numbers are the 4 parameter measurements of the n points.

In the point measurement and list sweep, if the measurement error (Overload) occurs, the next implies the value of 1, otherwise 0.

If the comparator is turned on, the last digit is the BIN result, 10 (list sweep is 16) indicates that the BIN cannot be sorted into any BIN, 1-9 (list is 1-15) indicate the corresponding BIN sequence number, -1 indicates that the bin is failed due to the measurement error (usually Overload will appear)

◆ :FETC:CORR

Command Type: Query

Syntax: :FETCh[:IMPedance]:CORRected?

Description: Query the point measurement/list sweep corrected measurements (R-X)

Query Response:

Point: {< number>},{< number2>}<newline><^END>

List: {< point 1R value>},{< point 1X value>},..., {< point nR value>},{< point nX value>}<newline><^END>

In the response to the point measurement, number 1 is the R value and number 2 is the X value.

In the response to the list sweep, n is the number of measurement points in the list, and the parameters of the response are the R and X values of each point in turn.

◆ :FETC:SMON:IAC

Command Type: Query

Syntax:

:FETCh:SMONitor:IAC?

Description: Query the measurement data of AC current monitoring in point measurement/list sweep

Query Response: {< number>}<newline><^END>

◆ :FETC:SMON:IDC

Command Type: Query

Syntax:

:FETCh:SMONitor:IDC?

Description: Query the measurement data of DC current monitoring in point measurement/list sweep

Query Response: {< number>}<newline><^END>

◆ :FETC:SMON:VAC

Command Type: Query

Syntax:

:FETCh:SMONitor:VAC?

Description: Query the measurement data of AC voltage monitoring in point measurement/list sweep

Query Response: {< number>}<newline><^END>

◆ :FETC:SMON:VDC

Command Type: Query

Syntax:

:FETCh:SMONitor:VDC?

Description: Query the measurement data of DC voltage monitoring in point measurement/list sweep

Query Response: {< number>}<newline><^END>

9.2.4.9 FREQUENCY

:FREQ

Command Type: Command/Query

Syntax:

:FREQuency < number >

:FREQuency?

Description: Set or query the frequency of the point measurement

Parameters:

Parameters	Numerical Value
Description	Measurement Frequency
Data Type	Double precision type (Double)
Range	10Hz - 130MHz
Preset Value	1000Hz

Examples:

Set the frequency to 1MHz:

:FREQ 1E6

Query the current measurement frequency:

:FREQ?

Query Response: {< number>}<newline><^END>

Related keys: Meas Setup > Frequency

9.2.4.10 FUNCTION

◆ :FUNC:DEV{1-4}:MODE

Command Type: Command/Query

Syntax:

:FUNCTION:DEV{1|2|3|4}:MODE {OFF|ABSolute|PERCent}

:FUNCTION:DEV{1|2|3|4}:MODE?

Description: Set or query the math mode of the selected measurement parameter

Parameters:

Parameter	Selection Option
Description	Math Mode
Data Type	Character string type (String)
Range	OFF: OFF ABSolute: Deviation mode PERCent: Deviation percent mode
Preset Value	OFF

Examples:

Set the math mode of parameter 1 to the deviation mode:

:FUNC:DEV1:MODE ABS

Query the math mode of parameter 2:

:FUNC:DEV1:MODE?

Query Response: {OFF|ABS|PERC }<newline><^END>

Related keys: [Display](#) > [Parameter](#) > [Math Mode](#)

◆ :FUNC:DEV{1-4}:REF

Command Type: Command/Query

Syntax:

:FUNCTION:DEV{1|2|3|4}:REFerence < number>

:FUNCTION:DEV{1|2|3|4}:REFerence?

Description: Set or query the reference value of the selected measurement parameter

Parameters:

Parameter	Numerical Value
Description	Reference value
Data Type	Double precision type (double)
Range	-1E9 - 1E9
Preset Value	0
Unit	Depends on measurement parameters

Examples:

Set the reference value of parameter 1 to 1000:

:FUNC:DEV1:REF 1E3

Query the reference value of parameter 2:

:FUNC:DEV1:REF?

Query Response: {< number> }<newline><^END>

Related keys: [Display](#) > [Parameter](#) > [Reference](#)

◆ :FUNC:IMP:RANG

Command Type: Command/Query

Syntax:

:FUNCtion:IMPedance:RANGe { AUTO|50|500|5K|50K }

:FUNCtion:IMPedance:RANGe?

Description: Set or query the AC range of the point measurement

Parameters:

Parameter	Selection Option
Description	AC range
Data Type	Character string type (String)
Range	AUTO: AUTO 50: 50Ω 500: 500Ω 5K: 5kΩ 50K: 50kΩ
Preset Value	AUTO

Examples:

Set the AC range to AUTO:

:FUNC:IMP:RANG AUTO

Query the current AC range:

:FUNC:IMP:RANG?

Query Response: {AUTO|50|500|5K|50K}< newline><^END>

Related keys: Meas Setup > ACRange

◆ :FUNC:PAR{1-4}:FORM

Command Type: Command/Query

Syntax:

:FUNction:PARAmater{1|2|3|4}:FORMat

{Z|Y|TZR|TZD|TYR|TYD|RS|RP|LS|LP|CS|CP|R|G|X|B |Q|D}

:FUNction:PARAmater{1|2|3|4}:FORMat?

Description: Set and query the parameter name of the selected measurement parameter

Parameters:

Parameter	Selection Option
Description	Point measurement parameter
Data Type	Character string type (String)
Range	Z: Z Y: Y TZR.θ z(rad) TZD.θ z(deg) TYR.θ y(rad) TYD.θ y(deg) RS: Rs RP: Rp LS: Ls LP: Lp CS: Cs CP: Cp R: R G: G X: X B: B Q: Q D: D

	DCR: DCR ER: $ \epsilon $ (requires permittivity module support) ER1: ϵ' (requires permittivity module support) ER1: ϵ'' (requires permittivity module support) U1: μ' (requires troidalcore module support) U2: μ'' (requires troidalcore module support) TAN: $\tan \delta$ (requires troidalcore module support)
Preset Value	Z

Examples:

Set the parameter 1 to |Z|:

:FUNC:PAR1:FORM Z

Query the parameter name of parameter 2:

:FUNC:PAR2:FORM?

Query Response:

{Z|Y|TZR|TZD|TYR|TYD|RS|RP|LS|LP|CS|CPR|G|X|B|Q|D|ER|ER1|ER2|U1|U2|TAN}
<newline><^END>

Related keys: [Display](#) > [Parameter](#) > [Parameter](#)

◆ :FUNC:SMON:{IAC|VAC}

Command Type: Command/Query

Syntax:

:FUNCtion:SMONitor:{IAC|VAC} {ON|OFF|1|0}

:FUNCtion:SMONitor:{IAC|VAC}?

Description: Set or query the on-off state of AC monitor, when it is OFF, the DC monitor will be on

Parameters:

Parameter	Selection Option
Description	AC monitor state
Data Type	Boolean type (Boolean)

Range	ON OFF 1 0
Preset Value	ON

Examples:

Turn on the AC monitor:

:FUNC:SMON:IAC ON

Query the on-off state of the AC monitor:

:FUNC:SMON:IAC?

Query Response: {1|0}< newline><^END>

Related keys: Meas Setup > AC/DC Monitor

◆ :FUNC:SMON:{IDC|VDC}

Command Type: Command/Query

Syntax:

:FUNCTION:SMONitor:{IDC|VDC} {ON|OFF|1|0}

:FUNCTION:SMONitor:{IDC|VDC}?

Description: Set or query the on-off state of DC monitor, when it is off, the AC monitor will be on

Parameters:

Parameter	Selection Option
Description	DC monitor state
Data Type	Boolean type (Boolean)
Range	ON OFF 1 0
Preset Value	OFF

Examples:

Turn on the AC monitor:

:FUNC:SMON:IDC ON

Query the open state of the AC monitor:

:FUNC:SMON:IDC?

Query Response: {1|0}< newline><^END>

Related keys: Meas Setup > AC/DC Monitor

9.2.4.11 INITIATE

◆ :INIT

Command Type: Command

Syntax:

:INITiate

Description: Set the trigger mode to internal trigger

◆ :INIT:CONT

Command Type: Command/Query

Syntax:

:INITiate:CONTInuos {ON|OFF|1|0}

:INITiate:CONTInuos?

Description: Set the trigger mode to internal trigger, query whether the current trigger mode is internal trigger

Parameters:

Parameter	Selection Option
Description	Internal trigger state
Data Type	Boolean type (Boolean)
Range	ON OFF 1 0
Preset Value	OFF

Examples:

Set the point measurement trigger mode to internal trigger:

:INIT:CONT ON

Query whether it is internal trigger:

:INIT:CONT?

Query Response: {1|0}< newline><^END>

9.2.4.12 LIST

◆ :LIST:APER

Command Type: Command/Query

Syntax:

:LIST:APERture {1|2|3|4|5}

:LIST:APERture?

Description: Set or query the measurement time of the list sweep

Parameters:

Parameter	Selection Option
Description	Measurement time
Data Type	Numeric type (Integer)
Range	1 2 3 4 5
Preset Value	1

Examples:

Set the measurement time to 2:

:LIST:APER 2

Query the list measurement time:

:LIST:APER?

Query Response: {1|2|3|4|5}< newline><^END>

Related keys: Meas Setup > Meas Time

◆ :LIST:BIAS:CURR

Command Type: Command/Query

Syntax:

:LIST:BIAS:CURRent[point number] < number>

:LIST:BIAS:CURRent[point serial number]?

Description: Set or query the DC bias current of the selected measurement point in the list sweep. The setting does not mean that the DC bias is switched on.

Parameters:

Parameter	Numerical Value
Description	DC bias current
Data Type	Double precision type (double)
Range	-0.1 - 0.1
Unit	A

Preset Value	0
--------------	---

Examples:

Set the bias current of the 10th point to 0.1A:

:LIST:BIAS:CURR10 0.1

Query the bias current of the 20th point:

:LIST:BIAS:CURR20?

Query Response: {< number>}<newline><^END>

Related keys: [Stim Table](#) > [DC Bias](#)

◆ :LIST:BIAS:MODE

Command Type: Command/Query

Syntax:

:LIST:BIAS:MODE[point serial number] {VOLTage|CURRent}

:LIST:BIAS:MODE[point serial number]?

Description: Set or query the DC bias mode of the selected measurement point in the list sweep. The setting does not mean that the DC bias is switched on.

Parameters:

Parameter	Selection Option
Description	DC bias mode
Data Type	Character string type (String)
Range	VOLT: Voltage mode CURR: Current mode
Preset Value	VOLT

Examples:

Set the DC bias mode of the 10th point to voltage mode:

:LIST:BIAS:MODE10 VOLT

Query the DC bias mode of the 20th point:

:LIST:BIAS:MODE20?

Query Response: {VOLT|CURR}< newline><^END>

Related keys: [Stim Table](#) > [Bias Mode](#)

◆ :LIST:BIAS:RANG

Command Type: Command/Query

Syntax:

:LIST:BIAS:RANGe[point serial number] {M1|M10|M100}

:LIST:BIAS:RANGe[point serial number]?

Description: Set or query the DC bias range of the selected measurement point in the list sweep.
The setting does not mean that the DC bias is switched on.

Parameters:

Parameter	Selection Option
Description	DC bias range
Data Type	Character string type (String)
Range	M1: 1mA M10: 10mA M100: 100mA
Preset Value	M1

Examples:

Set the DC bias range of the 10th point to 1mA:

:LIST:BIAS:RANG10 M1

Query the DC bias current of the 20th point:

:LIST:BIAS:RANG20?

Query Response: {M1|M10|M100}< newline><^END>

Related keys: [Stim Table](#) > [Meas Range](#)

◆ :LIST:BIAS:STAT

Command Type: Command/Query

Syntax:

:LIST:BIAS:STATe[Stimulus] {ON|OFF|1|0}

:LIST:BIAS:STATe[Stimulus]?

Description: Set or query the on-off state of the DC bias of the selected measurement point in the list sweep

Parameters:

Parameter	Selection Option
Description	DC bias state
Data Type	Boolean type (Boolean)
Range	ON OFF 1 0
Preset Value	OFF

Examples:

Turn on the DC bias of the 10th point:

:LIST:BIAS:STAT10 ON

Query the DC bias state of the 20th point:

:LIST:BIAS:STAT20?

Query Response: {1|0}< newline><^END>

Related keys: [Stim Table](#) > [Bias State](#)

◆ :LIST:BIAS:VOLT

Command Type: Command/Query

Syntax:

:LIST:BIAS:VOLTage[Stimulus] < number>

:LIST:BIAS:VOLTage [Stimulus]?

Description: Set or query the DC bias voltage of the selected measurement point in the list sweep. The setting does not mean that the DC bias is switched on.

Parameters:

Parameter	Numerical Value
Description	DC bias voltage
Data Type	Double precision type (double)
Range	-40 - 40
Unit	V
Preset Value	0

Examples:

Set the bias voltage of the 10th point to 1V:

:LIST:BIAS:VOLT10 1

Query the bias voltage of the 20th point:

:LIST:BIAS:VOLT20?

Query Response: {< number>}<newline><^END>

Related keys: [Stim Table](#) > [DC Bias](#)

◆ :LIST:CLE

Command Type: Command

Syntax: :LIST:CLEar

Description: Clear the list measurement points of the current page, restore them to the default value

◆ :LIST:CLE:ALL

Command Type: Command

Syntax: :LIST:CLEar:ALL

Description: Clear the list measurement points of all pages, restore them to the default value

◆ :LIST:COMP

Command Type: Command/Query

Syntax:

:LIST:COMParator[::STATe] {ON|OFF|1|0}

:LIST:COMParator[::STATe]?

Description: Set or query the list comparator state

Parameters:

Parameter	Selection Option
Description	Comparator state
Data Type	Boolean type (Boolean)
Range	On Off 1 0
Preset Value	Off

Examples:

Turn on the list comparator:

:LIST:COMP ON

Query the list comparator state:

:LIST:COMP?

Query Response: {1|0}< newline><^END>

Related keys: [Comparator](#) > [Comparator State](#)

◆ :LIST:COMP:BIN{1-15}

Command Type: Command/Query

Syntax:

:LIST:COMPArator:BIN{1-15} [:STATe] {ON|OFF|1|0}

:LIST:COMPArator:BIN{1-15} [:STATe]?

Description: Set or query the state of BIN (1-15) in the list comparator

Parameters:

Parameter	Selection Option
Description	BIN state
Data Type	Boolean type (Boolean)
Range	ON OFF 1 0
Preset Value	OFF

Examples:

Turn on the BIN1:

:LIST:COMP:BIN1 ON

Query the on-off state of BIN2:

:LIST:COMP:BIN2?

Query Response: {1|0}< newline><^END>

Related keys: [Stim Table](#) > [Comparator](#) > [BIN](#) > [State](#)

◆ :LIST:COMP:BIN{1-15}:COND{1-4}:LIM

Command Type: Command/Query

Syntax:

:LIST:COMPArator:BIN{1-15}:CONDition{1|2|3|4}:LIMit <number1>,<number2>

:LIST:COMPArator:BIN{1-15}:CONDition{1|2|3|4}:LIMit?

Description: Set and query the limit line of the comparator condition setting (1-4) of BIN (1-15) in the list. The limit line contains the upper and lower limit values.

Parameters:

Parameter	< Number 1 >	< Number 2 >
Description	Lower Value	Upper Value
Data Type	Double precision type (double)	Double precision type (double)
Range	-1E9 - 1E9	-1E9 - 1E9
Preset Value	0	0
Unit	Depends on comparator parameters	Depends on comparator parameters

Examples:

Set the upper limit of BIN1 condition 1 to 2k and the lower limit to 1k:

:LIST:COMP:BIN1:COND1:LIM 1E3,2E3

Query the upper and lower limits of BIN2 condition 2:

:LIST:COMP:BIN2:COND2:LIM?

Query Response: {< number1>}, {< number2>}<newline><^END>

Related keys: Stim Table > Comparator > BIN > Upper/Lower

◆ :LIST:COMP:BIN{1-15}:COND{1-4}:LTYP

Command Type: Command/Query

Syntax:

:LIST:COMParator:BIN{1-15}:CONDition{1|2|3|4}:LTYPe {IN|OUT|ALL}

:LIST

Description: Set and query the limit line type of the comparator condition setting (1-4) of BIN (1-15) in the list

Parameters:

Parameters	Selection Option
Description	Limit line type
Data Type	Character string type (String)
Range	IN OUT ALL
Preset Value	ALL

Examples:

Set the limit line type of BIN1 Condition 1 to IN:

```
:LIST:COMP:BIN1:COND1:LTYP IN
```

Query the limit line type of BIN2 Condition 2:

```
:LIST:COMP:BIN2:COND2:LTYP?
```

Query Response: {IN|OUT|ALL}< newline><^END>

Related keys: Stim Table > Comparator > BIN > In/Out

◆ :LIST:COMP:BIN{1-15}:COND{1-4}:MODE

Command Type: Command/Query

Syntax:

```
:LIST:COMParator:BIN{1-15}:CONDition{1|2|3|4}:MODE {OFF|DEV|PCNT|PDEV}
```

```
:LIST:COMParator:BIN{1-15}:CONDition{1|2|3|4}:MODE?
```

Description: Set and query the data math of the comparator condition setting (1-4) of the list comparator setting BIN (1-15)

Parameters:

Parameter	Selection Option
Description	Comparator data math
Data Type	Character string type (String)
Range	OFF: OFF DEV: Deviation PCNT: Percent PDEV: Percent Deviation
Preset Value	OFF

Examples:

Set the data math of BIN1 Conditon 1 to Deviation:

```
:LIST:COMP:BIN1:COND1:MODE DEV
```

Query the data math of BIN2 Condition 2:

```
:LIST:COMP:BIN2:COND2:MODE?
```

Query Response: {OFF|DEV|PCNT|PDEV}< newline><^END>

Related keys: Stim Table > Comparator > BIN > Mode

◆ :LIST:COMP:BIN{1-15}:COND{1-4}:NOM

Command Type: Command/Query

Syntax:

:LIST:COMP:BIN{1-15}:CONDition{1|2|3|4}:NOMinal < number>

:LIST:COMP:BIN{1-15}:CONDition{1|2|3|4}:NOMinal?

Description: Set or query the reference value of the comparator condition setting (1-4) of the list comparator BIN (1-15)

Parameters:

Parameter	Numerical Value
Description	Comparator reference value
Data Type	Double precision type (double)
Range	-1E9 - 1E9
Preset Value	0

Examples:

Set the reference value of BIN1 Condition 1 to 1000:

:LIST:COMP:BIN1:COND1:NOM 1E3

Query the reference value of BIN2 Condition 2:

:LIST:COMP:BIN2:COND2:NOM?

Query Response: {< number>}<newline><^END>

Related keys: Stim Table > Comparator > BIN > Reference

◆ :LIST:COMP:CLE

Command Type: Command

Syntax: :LIST:COMP:CLEar

Description: Restore all list comparator settings to the initial values

Related keys: Stim Table > Comparator > All Tables > Clear All

:LIST:COMP:COND{1-4}:PAR

Command Type: Command/Query

Syntax:

:LIST:COMParator:CONDition{ 1|2|3|4 }:PARAmeter
 {Z|Y|TZR|TZD|TYR|TYD|RS|RP|LS|LP|CS| CP|R|G|X|B|Q|D}

:LIST:COMParator:CONDition{ 1|2|3|4 }:PARAmeter?

Description: Set or query the measurement parameters of the list comparator setting condition (1-4)

Parameters:

Parameter	Selection Option
Description	Comparator measurement parameter
Data Type	Character string type (String)
Range	Z: Z Y: Y TZR.θ z(rad) TZD.θ z(deg) TYR.θ y(rad) TYD.θ y(deg) RS: Rs RP: Rp LS: Ls LP: Lp CS: Cs CP: Cp R: R G: G X: X B: B Q: Q D: D
Preset Value	Z

Examples:

Set the parameters of Condition 1 to R:

:LIST:COMP:COND1:PAR R

Query the parameters of Condition 2:

:LIST:COMP:COND2:PAR?

Query Response:

{Z|Y|TZR|TZD|TYR|TYD|RS|RP|LS|LP|CS|CP|R|G|X|B|Q|D }<newline><^END>

Related keys: Stim Table > Comparator > Parameter

◆ :LIST:COMP:COUN

Command Type: Command/Query

Syntax:

:LIST:COMPArator:COUNt[:STATe] {ON|OFF|1|0}

:LIST:COMPArator:COUNt[:STATe]?

Description: Set or query the open state of the list comparator count

Parameters:

Parameter	Selection Option
Description	Comparator count state
Data Type	Boolean type (Boolean)
Range	ON OFF 1 0
Preset Value	ON

Examples:

Turn on the comparator count:

:LIST:COMP:COUN ON

Query the on-off state of the comparator count:

:LIST:COMP:COUN?

Query Response: {1|0}< newline><^END>

Related keys: Comparator > Bin Count

◆ :LIST:COMP:COUN:CLE

Command Type: Command

Syntax:

:LIST:COMPArator:COUNt:CLEAr

Description: Clear the count of the current list comparator

Related keys: Comparator > Clear Bin Count

◆ :LIST:COMP:DATA:BCO

Command Type: Query

Syntax:

:LIST:COMP:DATA:BCO?<number>

Description: query the comparator count of each BIN in the list

Query Response: {< number 1>}, {< number 2>},{< number 3>}, {< number 4>},{< number 5>}, {< number 6>},{< number 7>}, {< number 8>},{< number 9>}, {< number 10>}< newline><^END>

Number 1 – number 9 represent the comparator count of BIN 1 - BIN 9, and the number 10 represents counts that fail to be sorted into any BIN (Out of Good)

◆ :LIST:COMP:DATA:BIN

Command Type: Query

Syntax:

:LIST:COMP:DATA:BIN?<number>

Description: Query the most recent comparator result

Query Response: {0|1|2|3|4|5|6|7|8|9|10}< newline><^END>

In the command, 0 indicates that the BIN cannot be sorted into any BIN, 1-9 indicate the corresponding BIN sequence number, and 10 indicates the comparator failure caused by measurement errors (usually Overload)

◆ :LIST:COUN

Command Type: Command/Query

Syntax:

:LIST:COUN[Stimulus] < number>

:LIST:COUN[Stimulus]?

Description: Set or query the average count of the selected measurement points in the list sweep.

Parameters:

Parameter	Numerical Value
Description	Average count
Data Type	Numeric type (Integer)
Range	1 - 999

Preset Value	1
--------------	---

Examples:

Set the average count of the 10th point to 5:

:LIST:COUN10 5

Query the average count of the 20th point:

:LIST:COUN20?

Query Response: {< number>}<newline><^END>

Related keys: Stim Table > Avg Count

◆ :LIST:CURR

Command Type: Command/Query

Syntax:

:LIST:CURRent[Stimulus] < number>

:LIST:CURRent[Stimulus]?

Description: Set or query the signal source current of the selected measurement point in the list sweep.

Parameters:

Parameter	Numerical Value
Description	Signal source current
Data Type	Double precision type (double)
Range	0.0002 - 0.02
Unit	A
Preset Value	0.02

Examples:

Set the signal source current of the 10th point to 1mA:

:LIST:CURR10 1E-3

Query the signal source current of the 20th point:

:LIST:CURR20?

Query Response: {< number>}<newline><^END>

Related keys: Stim Table > OSC Level

◆ :LIST:DEL

Command Type: Command/Query

Syntax:

:LIST:DELay[Stimulus] < number>

:LIST:DELay[Stimulus]?

Description: Set or query the point delay of the selected point

Parameters:

Parameter	Numerical Value
Description	Point delay
Data Type	Double precision type (double)
Range	0s - 30s
Preset Value	0s

Examples:

Set the point delay of point 10 to 100ms:

:LIST:DEL10 0.01

Query the point delay of point 20:

:LIST:DEL20?

Query Response: {< number>}<newline><^END>

Related keys: [Stim Table](#) > [Point Delay](#)

◆ :LIST:FREQ

Command Type: Command/Query

Syntax:

:LIST:FREQ[Stimulus] < number>

:LIST:FREQ[Stimulus]?

Description: Set or query the measurement frequency of the selected point

Parameters:

Parameter	Numerical Value
Description	Measurement

	frequency
Data Type	Double precision type (double)
Range	10Hz - 130MHz
Preset Value	1000Hz

Examples:

Set the frequency of point 10 to 1MHz:

:LIST:FREQ10 1E6

Query the measurement frequency of point 20:

:LIST:FREQ20?

Query response: {<number>}<newline><^END>

Related keys: [Stim Table](#) > [Frequency](#)

◆ :LIST:MODE

Command Type: Command/Query

Syntax:

:LIST:MODE {SEQuence|STEP}

:LIST:MODE?

Description: Set the list type of the list sweep

Parameters:

Parameter	Selection Option
Description	List type
Data Type	Character string type (String)
Range	SEQ: Sequence STEP: Step
Preset Value	SEQ

Examples:

Set the list type to Sequence:

:LIST:MODE SEQ

Query list type:

:LIST:MODE?

Query Response: {SEQ|STEP}< newline><^END>

Related keys: **Point/List** > **List Type**

◆ :LIST:OSC

Command Type: Command/Query

Syntax:

:LIST:OSC[Stimulus] {VOLTage|CURRent}

:LIST:OSC[Stimulus]?

Description: Set or query the signal source level mode of the selected measurement point

Parameters:

Parameter	Selection Option
Description	List type
Data Type	Character string type (String)
Range	VOLT: Voltage mode CURR: Current mode
Preset Value	VOLT

Examples:

Set the 10th point signal source to voltage mode:

:LIST:OSC10 VOLT

Query the signal source mode of the 20th point:

:LIST:OSC20?

Query Response: {VOLT|CURR}< newline><^END>

Related keys: **Stim Table** > **OSC Mode**

◆ :LIST:PAR:FORM

Command Type: Command/Query

Syntax:

:LIST:PARAmeter{1|2|3|4}:FORMat

{Z|Y|TZR|TZD|TYR|TYD|RS|RP|LS|LP|CS|CP|R|G|X|B|Q|D}

:LIST:PARAmeter{1|2|3|4}:FORMat?

Description: Set or query the parameter name of the specified measurement parameter

Parameters:

Parameter	Selection Option
Description	Measurement parameter
Data Type	Character string type (String)
Range	Z: Z Y: Y TZR.θ z(rad) TZD.θ z(deg) TYR.θ y(rad) TYD.θ y(deg) RS: Rs RP: Rp LS: Ls LP: Lp CS: Cs CP: Cp R: R G: G X: X B: B Q: Q D: D ER: εr (requires permittivity module support) ER1: εr' (requires permittivity module support) ER2: εr'' (requires permittivity module support) U1: μ' (requires troidalcore module support) U2: μ'' (requires troidalcore module support) TAN: tan δ (requires troidalcore module support) NONE: None (not displayed)
Preset Value	Z

Examples:

Set the parameter 1 to |Z|:

:LIST:PAR1:FORM Z

Query the parameter name of the parameter 2:

:LIST:PAR2:FORM?

Query Response:
 {Z|Y|TZR|TZD|TYR|TYD|RS|RP|LS|LP|CS|CP|R|G|X|B|Q|D|ER|ER1|ER2|U1|U2|TAN}
 <newline><^END>

Related keys: **Display** > **Parameter**

◆ :LIST:PERM:A1

Command Type: Command/Query

Syntax:

:LIST:PERMittivity:A1 {ON|OFF|1|0}

:LIST:PERMittivity:A1?

Description: Set or query the electrode in the calculation of permittivity. This command must be enabled with the permittivity permission before it can be used.

Parameters:

Parameter	Selection Option
Description	Display State
Data Type	Boolean type (Boolean)
Range	ON OFF 1 0
Commands	ON: Electrode is A1 OFF: Electrode is A2
Preset Value	ON

Examples:

Set the current electrode to A1:

:LIST:PERM:A1 ON

Query the electrode:

:LIST:PERM:A1?

Query Response: {1|0}< newline><^END>

Related keys: **Point/List** > **Electrode**

◆ :LIST:PERM:THIC

Command Type: Command/Query

Syntax:

:LIST:PERMittivity:THICkness < number>

:LIST:PERMittivity:THICkness?

Description: Set or query the thickness in the calculation of permittivity. This command must be enabled with the permittivity permission before it can be used.

Parameters:

Parameter	Numerical Value
Description	Thickness
Data Type	Double precision type (double)
Range	1E-9 - 999
Unit	m
Preset Value	0.01

Examples:

Set the thickness to 5mm:

:LIST:PERM:THIC 5E-3

Query the thickness:

:LIST:PERM:THIC?

Query Response: {< number>}<newline><^END>

Related keys: [Point/List](#) > [Thickness](#)

◆ :LIST:POIN

Command Type: Command/Query

Syntax:

:LIST:POINT < number>

:LIST:POINT?

Description: Set or query the number of measurement points in the list sweep, the measurement point parameter set by this command will be the default parameter.

Parameters:

Parameter	Numerical Value
Description	Number of measurement points
Data Type	Numeric type (Integer)
Range	1 - 1601

Preset Value	1
--------------	---

Examples:

Set the number of measurement points to 20:

:LIST:POIN 20

Query the number of measurement points:

:LIST:POIN?

Query Response: {< number>}<newline><^END>

◆ :LIST:RANG

Command Type: Command/Query

Syntax:

:LIST:RANGe [Stimulus] {AUTO|50|500|5K|50K}

:LIST:RANGe [Stimulus]?

Description: Set or query the AC range of the selected measurement point

Parameters:

Parameter	Selection Option
Description	AC range
Data Type	Character string type (String)
Range	AUTO: Auto range 50: 50Ω 500: 500Ω 5K: 5kΩ 50K: 50kΩ
Preset Value	AUTO

Examples:

Set the AC range of the 10th point to auto range:

:LIST:RANG10 AUTO

Query the AC range of the 20th point:

:LIST:RANG20?

Query Response: AUTO|50|500|5K|50K}< newline><^END>

Related keys: Stim Table > AC Range

◆ :LIST:TRIG

Command Type: Command/Query

Syntax:

:LIST:TRIG {INTernal|MANualEXTernal|BUS}

:LIST:TRIG?

Description: Set the trigger mode of the list sweep

Parameters:

Parameter	Selection Option
Description	Trigger mode
Data Type	Character string type (String)
Range	INT: Internal trigger MAN: Manual trigger EXT: External trigger BUS: Bus trigger
Preset Value	INT

Examples:

Set the trigger mode to manual trigger:

:LIST:TRIG MAN

Query the current trigger mode:

:LIST:TRIG?

Query Response: {INT|MAN|EXT|BUS}< newline><^END>

Related keys: [Point/List](#) > [Trigger Mode](#)

◆ :LIST:TROI:HEIG

Command Type: Command/Query

Syntax:

:LIST:TROI:core:HEIGht?

:LIST:TROI:core:HEIGht < number>

Description: Set and query the troidal core height in the calculation of troidalcore. This command must be enabled with the troidalcore permission before it can be used.

Parameters:

Parameter	Numerical Value
Description	Troidal core height
Data Type	Double precision type (double)
Range	1e-9 - 999
Preset Value	0.005
Unit	m

Examples:

Set the troidal core height to 10mm:

```
:LIST:TROI:HEIG 0.01
```

Query the troidal core height:

```
:LIST:TROI:HEIG?
```

Query Response: {< number>}<newline><^END>

Related keys: [Point/List](#) > [Troidal core Height](#)

◆ :LIST:TROI:INN

Command Type: Command/Query

Syntax:

```
:LIST:TROI:INN?
```

```
:LIST:TROI:INN < number>
```

Description: Set and query the troidal core inner in the calculation of troidalcore. This command must be enabled with the troidalcore permission before it can be used.

Parameters:

Parameter	Numerical Value
Description	Troidal core inner
Data Type	Double precision type (double)
Range	1e-9 - 999
Preset Value	0.008
Unit	m

Examples:

Set the troidal core inner to 10 mm:

```
:LIST:TROI:INN 0.01
```

Query the troidal core inner:

:LIST:TROI:INN?

Query Response: {< number>}<newline><^END>

Related keys: Point/List > Troidal core Inner

◆ :LIST:TROI:OUT

Command Type: Command/Query

Syntax:

:LIST:TROI:OUTer?

:LIST:TROI:OUTer < number>

Description: Set and query the troidal core outer in the calculation of troidalcore. This command must be enabled with the troidalcore permission before it can be used.

Parameters:

Parameter	Numerical Value
Description	Troidal core outer
Data Type	Double precision type (double)
Range	1e-9 - 999
Preset Value	0.015
Unit	m

Examples:

Set the troidal core outer to 20mm:

:LIST:TROI:OUT 0.02

Query the troidal core outer:

:LIST:TROI:OUT?

Query Response: {< number>}<newline><^END>

Related keys: Point/List > Troidal core Outer

◆ :LIST:VOLT

Command Type: Command/Query

Syntax:

:LIST:VOLTage[Stimulus] < number>

:LIST:VOLTage [Stimulus]?

Description: Set or query the signal source voltage of the selected measurement point in the list sweep.

Parameters:

Parameter	Numerical Value
Description	Signal source voltage
Data Type	Double precision type (double)
Range	0.005 - 1
Unit	V
Preset Value	0.5

Examples:

Set the signal source voltage of the 10th point to 1V:

:LIST:VOLT10 1

Query the signal source voltage of the 20th point:

:LIST:VOLT20?

Query Response: {< number>}<newline><<^END>

Related keys: [Stim Table](#) > [OSC Level](#)

9.2.4.13 PERMITTIVITY

◆ :PERM:A1

Command Type: Command/Query

Syntax:

:PERMittivity:A1 {ON|OFF|1|0}

:PERMittivity:A1?

Description: Set or query the electrode in the calculation of permittivity. This command must be enabled with the permittivity permission before it can be used.

Parameters:

Parameter	Selection Option
Description	Display
Data Type	Boolean type (Boolean)
Range	ON OFF 1 0
Commands	ON: Electrode is A1

	OFF: Electrode is A2
Preset Value	ON

Examples:

Set the current electrode to A1:

:PERM:A1 ON

Query the electrode:

:PERM:A1?

Query Response: {1|0}< newline><^END>

Related keys: Meas Setup > Electrode

◆ :PERM:THIC

Command Type: Command/Query

Syntax:

:PERMittivity:THICkness < number>

:PERMittivity:THICkness?

Description: Set or query the thickness in the calculation of permittivity. This command must be enabled with the permittivity permission before it can be used.

Parameters:

Parameter	Numerical Value
Description	Thickness
Data Type	Double precision type (double)
Range	1E-9 - 999
Unit	m
Preset Value	0.01

Examples:

Set the thickness to 5 mm:

:PERM:THIC 5E-3

Query the thickness:

:PERM:THIC?

Query Response: {< number>}<newline><^END>

Related keys: Meas Setup > Thickness

9.2.4.14 MEMORY

◆ :MMEM:LIST

Command Type: Command

Syntax:

:MMEMory:LIST < filename>

Description: Save the list measurement data to the specified file name

Related keys: Save/Reall > Export List Data

◆ :MMEM:LOAD

Command Type: Command

Syntax:

:MMEMory:LOAD[:STATe] "< filename>"

Description: Load the measurement state settings file of the specified file path

Related keys: Save/Recall > Recall State > Recall State

◆ :MMEM:LOAD:STAT

Command Type: Command

Syntax:

:MMEMory:LOAD:STATe {1|2|3|4|5|6|7|8}

Description: Read the measurement state settings saved at the specified location

Parameters:

Parameter	Selection Option
Description	Measurement state position
Data Type	Numeric type (Integer)
Range	1 2 3 4 5 6 7 8

Examples: Read the data of position 3:

:MMEM:LOAD:STAT 3

Related keys: Save/Recall > Recall State

◆ :MMEM:STOR

Command Type: Command

Syntax:

:MMEMory:STOR[:STATe] "< filename>"

Description: Store the current measurement state settings to the specified file path

Related keys: [Save/Recall](#) > [Save State](#) > [Save State](#)

◆ :MMEM:STOR:STAT

Command Type: Command

Syntax:

:MMEMory:STORe:STATe {1|2|3|4|5|6|7|8}

Description: Store the current measurement state settings to the specified location

Parameters:

Parameter	Selection Option
Description	Measurement state position
Data Type	Numeric type (Integer)
Range	1 2 3 4 5 6 7 8

Examples: Store the measurement state settings in position 3:

:MMEM:STOR:STAT 3

Related keys: [Save/Recall](#) > [Save State](#)

9.2.4.15 TRIGGER

◆ :TRIG

Command Type: Command

Syntax:

:TRIGger

Description: Perform a trigger

◆ :TRIG:DEL

Command Type: Command/Query

Syntax:

:TRIGger:DELay < number>

:trigger:delay?

Description: Set or query the trigger delay of the point measurement

Parameters:

Parameter	Numerical Value
Description	Trigger delay
Data Type	Double precision type (double)
Range	0s - 30s
Preset Value	0s

Examples:

Set the point measurement trigger delay to 1 second:

:TRIG:DEL 1

Query the point measurement trigger delay:

:TRIG:DEL?

Query Response: {< number>}<newline><^END>

Related keys: Meas Setup > Trigger Delay

◆ :TRIG:SOUR

Command Type: Command/Query

Syntax:

:TRIGger:SOURce {INTernal|MANual|EXTernal|BUS}

:TRIGger:SOURce?

Description: Set the trigger mode of the point measurement

Parameters:

Parameter	Selection Option
Description	Trigger mode
Data Type	Character string type (String)

Range	INT: Internal trigger MAN: Manual trigger EXT: External trigger BUS: Bus trigger
Preset Value	INT

Examples:

Set the trigger mode to manual trigger:

:TRIG:SOUR MAN

Query the current trigger mode:

:TRIG:SOUR?

Query Response: {INT|MAN|EXT|BUS}< newline><^END>

Related keys: [Meas Setup](#) > [Trigger Mode](#)

9.2.4.16 TROIDALCORE

◆ :TROI:HEIG

Command Type: Command/Query

Syntax:

:TROI:HEIG?

:TROI:HEIG < number >

Description: Set and query the troidal core height in the calculation of troidalcore. This command must be enabled with the troidalcore permission before it can be used.

Parameters:

Parameter	Numerical Value
Description	Troidal core height
Data Type	Double precision type (double)
Range	1e-9 - 999
Preset Value	0.005
Unit	m

Examples:

Set the troidal core height to 10mm:

:TROI:HEIG 0.01

Query the troidal core height:

:TROI:HEIG?

Query Response: {< number>}<newline><^END>

Related keys: Meas Setup > Troidal core Height

◆ :TROI:INN

Command Type: Command/Query

Syntax:

:TROI:INN?

:TROI:INN < number>

Description: Set and query the troidal core inner in the calculation of troidalcore. This command must be enabled with the troidalcore permission before it can be used.

Parameters:

Parameter	Numerical Value
Description	Troidal core inner
Data Type	Double precision type (double)
Range	1e-9 - 999
Preset Value	0.008
Unit	m

Examples:

Set the troidal core inner to 10 mm:

:TROI:INN 0.01

Query the troidal core inner:

:TROI:INN?

Query Response: {< number>}<newline><^END>

Related keys: Meas Setup > Troidal core Inner

◆ :TROI:OUT

Command Type: Command/Query

Syntax:

:TROI:OUT?

:TROI:OUT < number>

Description: Set and query the troidal core outer in the calculation of troidalcore. This command must be enabled with the troidalcore permission before it can be used.

Parameters:

Parameter	Numerical Value
Description	Troidal core outer
Data Type	Double precision type (double)
Range	1e-9 - 999
Preset Value	0.015
Unit	m

Examples:

Set the troidal core outer to 20 mm:

:TROI:OUT 0.02

Query the troidal core outer:

:TROI:OUT?

Query Response: {< number>}<newline><^END>

Related keys: Meas Setup > Troidal core Outer

9.2.4.17 VOLTAGE

:VOLT

Command Type: Command/Query

Syntax:

:VOLTage < number>

:VOLTage?

Description: Set and query the voltage level of the point measurement signal source, and automatically set the level mode to voltage mode after setting the voltage.

Parameters:

Parameter	Numerical Value
Description	Signal source voltage
Data Type	Double precision type (double)
Range	0.005 - 1
Preset Value	0.5
Unit	V

Examples:

Set the voltage to 1V:

:VOLT 1

Query the voltage value:

:VOLT?

Query Response: {< number>}<newline><^END>

Related keys: Meas Setup > OSC Level > Voltage Level

9.2.5 Trace Sweep Command

This part introduces the related commands of the trace sweep. The commands entered in this part will take effect only if the current page belongs to the trace sweep (or its related setting interface).

9.2.5.1 ABORT

:ABOR

Command Type: Command

Syntax:

:ABORt

Description: Immediately terminate the current sweep cycle and start a new one

Related keys: Trigger Mode > Restart

9.2.5.2 CALCULATE

◆ :CALC<Ch>:AVER

Command Type: Command/Query

Syntax:

:CALCulate<Ch>:AVERage[:STATe] {ON|OFF|1|0}

:CALCulate<Ch>:AVERage[:STATe]?

Description: Set or query the averaging state of the selected measurement channel

Parameters:

Parameter	Selection Option
Description	Averaging

Data Type	Boolean type (Boolean)
Range	ON OFF 1 0
Preset Value	OFF

Examples:

Set the averaging of channel 1 to ON:

:CALC1:AVER ON

Query the averaging state of channel 2:

:CALC2:AVER?

Query Response: {1|0}< newline><^END>

Related keys: [Avg](#) > [Averaging](#)

◆ :CALC<Ch>:AVER:CLE

Command Type: Command

Syntax:

:CALCulate<Ch>:AVERage:CLEar

Description: Clear the averaging count of the selected measurement channel and restart

Related keys: [Avg](#) > [Averaging Restart](#)

◆ :CALC<Ch>:AVER:COUN

Command Type: Command/Query

Syntax:

:CALCulate<Ch>:AVERage:COUNt < number>

:CALCulate<Ch>:AVERage:COUNt?

Description: Set or query the averaging count of the selected measurement channel

Parameters:

Parameter	Numerical Value
Description	Averaging factor
Data Type	Numeric type (Integer)
Range	1 - 999
Preset Value	1

Examples:

Set the averaging count of channel 1 to 5:

:CALC1: AVER: COUN 5

Query the averaging count of channel 2:

:CALC2: AVER: COUN?

Query Response: {< number>}<newline><^END>

Related keys: Avg > Avg Factor

◆ :CALC<Ch>:DATA:FDAT

Command Type: Command/Query

Syntax:

:CALCulate<Ch>[:SElected]:DATA:FDATa < digit 1>,< digit 2>...< digit n*2>

:CALCulate<Ch>[:SElected]:DATA:FDATa?

Description: Set or query the measured value of the current trace of the specified channel

Parameters:

Parameter	Numerical Value
Description	Measured value of trace The number of measurement points is n. Each measurement point corresponds to two <number> The i-th measurement point input parameters are < digit i*2-1> and < digit i*2>, and < Number i*2-1> is the measurement data of the i-th point < number i*2> is fixed to 0
Data Type	Double precision type (double)
Note	If the number of <numbers> entered in the command is not equal to n*2, an error will be returned

Query Response: {< number 1>},{< number 2>}...{< number n*2>}<newline><^END>

◆ :CALC<Ch>:DATA:FMEM

Command Type: Command/Query

Syntax:

:CALCulate<Ch>[:SElected]:DATA:FMEMory < digit 1>,< digit 2>...< digit n*2>

:CALCulate<Ch>[:SElected]:DATA:FMEMory?

Description: Set or query the measured value of the current memory trace of the specified channel

Parameters:

Parameter	Numerical Value
Description	Measured value of memory trace The number of measurement points is n. Each measurement point corresponds to two <number> The i-th measurement point input parameters are < digit i*2-1> and < digit i*2>, and < Number i*2-1> is the measurement data of the i-th point < number i*2> is fixed to 0
Data Type	Double precision type (double)
Note	If the number of <numbers> entered in the command is not equal to n*2, an error will be returned

Query Response: {< number 1>},{< number 2>}...{< number n*2>}<newline><^END>

◆ :CALC<Ch>:DATA:RDAT

Command Type: Command/Query

Syntax:

:CALCulate<Ch>[:SElected]:DATA:RDATa < digit 1>,< digit 2>...< digit n*2>

:CALCulate<Ch>[:SElected]:DATA:RDATa?

Description: Set or query the measurement result of the current trace of the specified channel (R-X)

Parameters:

Parameter	Numerical Value
Description	Measured value of trace The number of measurement points is n. Each measurement point corresponds to two <number> The i-th measurement point input parameters are < digit i*2-1> and < digit i*2>, and < number i*2-1> is the R value of the i-th point < number i*2> is the X value of the i-th point
Data Type	Double precision type (double)
Note	If the number of <numbers> entered in the command is not

	equal to n*2, an error will be returned
--	---

Query Response: {< number 1>},{< number 2>}...{< number n*2>}<newline><^END>

◆ :CALC<Ch>:DATA:RMEM

Command Type: Command/Query

Syntax:

:CALCulate<Ch>[:SElected]:DATA:RMEMory < number 1>,< number 2>...< number n*2>

:CALCulate<Ch>[:SElected]:DATA:RMEMory?

Description: Set or query the measurement result of the current memory trace of the specified channel (R-X)

Parameters:

Parameter	Numerical Value
Description	Measured value of trace The number of measurement points is n. Each measurement point corresponds to two <number> The i-th measurement point input parameters are < digit i*2-1> and < digit i*2>, and < number i*2-1> is the R value of the i-th point < number i*2> is the X value of the i-th point
Data Type	Double precision type (double)
Note	If the number of <numbers> entered in the command is not equal to n*2, an error will be returned

Query Response: {< number 1>},{< number 2>}...{< number n*2>}<newline><^END>

◆ :CALC<Ch>:DATA:XAX

Command Type: Query

Syntax: :CALCulate<Ch>[:SElected]:DATA:XAXis?

Description: Get the value on the X-axis corresponding to each measurement point

Query Response: {< number 1>},{< number 2>}...{< number n>}<newline><^END>

◆ :CALC<Ch>:EPAR

Command Type: Command

Syntax: :CALCulate<Ch>:EPARameters[:EXECute]

Description: Execute equivalent circuit analysis of measured data for the selected channels with the selected models

Related keys: **Analysis** > **Equivalent Circuit** > **Calculate**

◆ :CALC<Ch>:EPAR:CIRC

Command Type: Command/Query

Syntax:

:CALCulate<Ch>:EPARameters:CIRCuit[:TYPE] {A|B|C|D|E|F|G}

:CALCulate<Ch>:EPARameters:CIRCuit[:TYPE]?

Description: Set or query the equivalent circuit model of the selected channels

Parameters:

Parameter	Selection Option
Description	Equivalent circuit model
Data Type	Character string type (String)
Range	A B C D E F G
Preset Value	A

Examples:

Set the equivalent circuit model of channel 1 to model C:

:CALC1:EPAR:CIRC C

Query the equivalent circuit model of channel 2:

:CALC2:EPAR:CIRC?

Query Response: {A|B|C|D|E|F|G}< newline><^END>

Related keys: **Analysis** > **Equivalent Circuit** > **Select Circuit**

◆ :CALC<Ch>:EPAR:CIRC:{A|B|C|D|E|F|G}:C1

Command Type: Command/Query

Syntax:

:CALCulate<Ch>:EPARameters:CIRCuit:{A|B|C|D|E|F|G}:C1 <number>

:CALCulate<Ch>:EPARameters:CIRCuit:{A|B|C|D|E|F|G}:C1?

Description: Set or query the capacitance value C1 corresponding to the selected equivalent circuit model in the selected channel

Parameters:

Parameter	Numerical Value
Description	Capacitance value C1
Data Type	Double precision type (double)
Range	-1E15 - 1E15
Preset Value	0
Unit	F

Examples:

Set the capacitor C1 value of channel 1 model C to 1nF:

:CALC1:EPAR:CIRC:C:C1 1E-9

Query the capacitor C1 value of channel 2 model A:

:CALC2:EPAR:CIRC:A:C1?

Query Response: <number><newline><^END>

Related keys: [Analysis](#) > [Equivalent Circuit](#) > [C1](#)

◆ :CALC<Ch>:EPAR:CIRC:{A|B|C|D|E|F|G}:L1

Command Type: Command/Query

Syntax:

:CALCulate<Ch>:EPARameters:CIRCuit:{A|B|C|D|E|F|G}:L1 < number>

:CALCulate<Ch>:EPARameters:CIRCuit:{A|B|C|D|E|F|G}:L1?

Description: Set or query the inductance value L1 corresponding to the selected equivalent circuit model in the selected channel

Parameters:

Parameters	Numerical Value
Description	Inductance value L1
Data Type	Double precision type (double)
Range	-1E15 - 1E15
Preset Value	0
Unit	H

Examples:

Set the inductor L1 value of channel 1 model C to 1nH:

:CALC1:EPAR:CIRC:C:L1 1E-9

Query the inductor L1 value of channel 2 model A:

:CALC2:EPAR:CIRC:A:L1?

Query Response: <number><newline><^END>

Related keys: [Analysis](#) > Equivalent Circuit > L1

◆ :CALC<Ch>:EPAR:CIRC:{A|B|C|D|E|F|G}:R1

Command Type: Command/Query

Syntax:

:CALCulate<Ch>:EPARameters:CIRCuit:{A|B|C|D|E|F|G}:R1 < number>

:CALCulate<Ch>:EPARameters:CIRCuit:{A|B|C|D|E|F|G}:R1?

Description: Set or query the resistance value R1 corresponding to the selected equivalent circuit model in the selected channel

Parameters:

Parameter	Numerical Value
Description	Resistance value R1
Data Type	Double precision type (double)
Range	-1E15 - 1E15
Preset Value	0
Unit	Ω

Examples:

Set the resistor R1 value of channel 1 model C to 1k Ω :

:CALC1:EPAR:CIRC:C:R1 1E3

Query the resistor R1 value of channel 2 model A:

:CALC2:EPAR:CIRC:A:R1?

Query Response: <number><newline><^END>

Related keys: [Analysis](#) > Equivalent Circuit > R1

◆ :CALC<Ch>:EPAR:CIRC:E:C0

Command Type: Command/Query

Syntax:

:CALCulate<Ch>:EPARameters:CIRCuit:E:C0 < number>

:CALCulate<Ch>:EPARameters:CIRCuit:E:C0?

Description: Set or query the capacitance value C0 corresponding to the equivalent circuit model E in the selected channel

Parameters:

Parameters	Numerical Value
Description	Capacitance value C0
Data Type	Double precision type (double)
Range	-1E15 - 1E15
Preset Value	0
Unit	F

Examples:

Set the capacitor C0 value of channel 1 model E to 1nF:

:CALC1:EPAR:CIRC:E:C0 1E-9

Query the capacitor C0 value of channel 2 model E:

:CALC2:EPAR:CIRC:E:C0?

Query Response: <number><newline><^END>

Related keys: [Analysis](#) > [Equivalent Circuit](#) > [C0](#)

◆ :CALC<Ch>:EPAR:CIRC:{F|G}:R1

Command Type: Command/Query

Syntax:

:CALCulate<Ch>:EPARameters:CIRCuit:{F|G}:R0 < number>

:CALCulate<Ch>:EPARameters:CIRCuit:{F|G}:R0?

Description: Set or query the resistance value R0 corresponding to the selected equivalent circuit model F or G in the selected channel

Parameters:

Parameter	Numerical Value
Description	Resistance value R0
Data Type	Double precision type (double)
Range	-1E15 - 1E15

Preset Value	0
Unit	Ω

Examples:

Set the resistor R0 value of channel 1 model F to 1k Ω :

:CALC1:EPAR:CIRC:F:R0 1E3

Query the resistor R0 value of channel 2 model G:

:CALC2:EPAR:CIRC:G:R0?

Query Response: <number><newline><^END>

Related keys: [Analysis](#) > [Equivalent Circuit](#) > [R0](#)

◆ :CALC<Ch>:EPAR:DISP

Command Type: Command/Query

Syntax:

:CALCulate<Ch>:EPARameters:DISPlay[:STATe] {ON|OFF|1|0}

:CALCulate<Ch>:EPARameters:DISPlay[:STATe]?

Description: Set or query the on-off state of the equivalent circuit model and calculation results displayed on the screen

Parameters:

Parameters	Selection Option
Description	Display
Data Type	Boolean type (Boolean)
Range	ON OFF 1 0
Preset Value	OFF

Examples:

Set the equivalent circuit display of channel 1 to ON:

:CALC1:EPAR:DISP ON

Query the on-off state of the equivalent circuit display of channel 2:

:CALC2:EPAR:DISP?

Query Response: {1|0}< newline><^END>

Related keys: [Analysis](#) > [Equivalent Circuit](#) > [Display](#)

◆ :CALC<Ch>:EPAR:SIM

Command Type: Command

Syntax: :CALCulate<Ch>:EPARameters:SIMulate[:IMMEDIATE]

Description: Immediately perform an equivalent circuit simulation calculation for the current set value of the selected channel and write the data into the trace and memory trace

Related keywords: [Analysis](#) > [Equivalent Circuit](#) > [Stimulate](#)

◆ :CALC<Ch>:EPAR:SIM:AUTO

Command Type: Command/Query

Syntax:

:CALCulate<Ch>:EPARameters:SIMulate:AUTO {ON|OFF|1|0}

:CALCulate<Ch>:EPARameters:SIMulate:AUTO?

Description: Set or query the open state of the automatic equivalent circuit simulation calculation of the selected channel. When it is set to ON, if an equivalent circuit parameter is modified, the simulation calculation will be performed automatically and the measurement results will be written to the trace and memory trace; when it is set to OFF, the results will not be written to the trace after the equivalent circuit simulation calculation is completed.

Parameters:

Parameter	Selection Option
Description	Stimulate
Data Type	Boolean type (Boolean)
Range	ON OFF 1 0
Preset Value	OFF

Examples:

Set the equivalent circuit auto simulation of channel 1 to ON:

:CALC1:EPAR:SIM:AUTO ON

Query the on-off state of the equivalent circuit auto simulation of channel 2:

:CALC2:EPAR:SIM:AUTO?

Query Response: {1|0}< newline><^END>

Related keys: [Analysis](#) > [Equivalent Circuit](#) > [Stimulate](#)

◆ :CALC<Ch>:LIM

Command Type: Command/Query

Syntax:

:CALCulate<Ch>[:SElected]:LIMit[:STATe] {ON|OFF|1|0}

:CALCulate<Ch>[:SElected]:LIMit[:STATe]?

Description: Set or query the on-off state of the sweep limit test

Parameters:

Parameter	Selection Option
Description	Trace sweep state
Data Type	Boolean type (Boolean)
Range	ON OFF 1 0
Preset Value	OFF

Examples:

Set the trace sweep of channel 1 to ON:

:CALC1:LIM ON

Query the on-off state of the trace sweep of channel 2:

:CALC2:LIM?

Query Response: {1|0}< newline><^END>

Related keys: [Analysis](#) > [Limit Test](#) > [Limit Test](#)

◆ :CALC<Ch>:MARK<Mk>

Command Type: Command/Query

Syntax:

:CALCulate<Ch>[:SElected]:MARKer<Mk>[:STATe] {ON|OFF|1|0}

:CALCulate<Ch>[:SElected]:MARKer<Mk>[:STATe]?

Description: Set or query the on-off state of the selected marker of the selected channel

Parameters:

Parameter	Selection Option
Description	Marker state
Data Type	Boolean (Boolean)
Range	ON OFF 1 0
Preset Value	OFF

Examples:

Set the marker 1 of channel 1 to ON:

:CALC1:MARK1 ON

Query the on-off state of marker 2 of channel 2:

:CALC2:MARK2?

Query Response: {1|0}< newline><^END>

Related keys: **Marker** > **Marker 1 - Marker 9**, **Reference Marker**

◆ :CALC<Ch>:MARK<Mk>:ACT

Command Type: Command

Syntax: :CALCulate<Ch>[:SElected]:MARKer<Mk>:ACTivate

Description: Activate the selected marker of the selected channel in the command

Related keys: **Marker** > **Marker 1 - Marker 9**, **Reference Marker**

◆ :CALC<Ch>:MARK:AOFF

Command Type: Command

Syntax: :CALCulate<Ch>[:SElected]:MARKer:AOFF

Description: Turn off all markers in the selected channel

Related keys: **Marker** > **Clear Markers** > **All OFF**

◆ :CALC<Ch>:MARK:COUP

Command Type: Command/Query

Syntax:

:CALCulate<Ch>[:SElected]:MARKer:COUple {ON|OFF|1|0}

:CALCulate<Ch>[:SElected]:MARKer:COUple?

Description: Set or query the on-off state of the marker couple of the selected channel

Parameters:

Parameter	Selection Option
Description	Marker couple
Data Type	Boolean type (Boolean)
Range	ON OFF 1 0

Preset Value	OFF
--------------	-----

Examples:

Set the marker of channel 1 to Couple:

:CALC1:MARK:COUP ON

Query the marker couple state of channel 2:

:CALC2:MARK:COUP?

Query Response: {1|0}< newline><^END>

Related keys: [Marker Function](#) > [Discrete](#)

◆ :CALC<Ch>:MARK:DISC

Command Type: Command/Query

Syntax:

:CALCulate<Ch>[:SElected]:MARKer:DISCrete {ON|OFF|1|0}

:CALCulate<Ch>[:SElected]:MARKer:DISCrete?

Description: Set or query whether the marker of the selected channel set is allowed to be positioned between the discrete points

Parameters:

Parameter	Selection Option
Description	Marker discrete point state
Data Type	Boolean type (Boolean)
Range	ON OFF 1 0
Preset Value	OFF

Examples:

Set the marker of channel 1 to position only to Discrete:

:CALC1:MARK:DISC ON

Query whether the marker of channel 2 can be positioned between the discrete points: :CALC2:MARK:DISC?

Query Response: {1|0}< newline><^END>

Related keys: [Marker Function](#) > [Couple](#)

◆ :CALC<Ch>:MARK:FUNC:DOM

Command Type: Command/Query

Syntax:

:CALCulate<Ch>[:SELEcted]:MARKer:FUNctio:n:DOMain[:STATe] {ON|OFF|1|0}

:CALCulate<Ch>[:SELEcted]:MARKer:FUNctio:n:DOMain[:STATe]?

Description: Set or query the open state of the marker search range of the selected channel

Parameters:

Parameter	Selection Option
Description	Marker search range state
Data Type	Boolean type (Boolean)
Range	ON OFF 1 0
Preset Value	OFF

Examples:

Set the marker search unit of channel 1 to ON:

:CALC1:MARK:FUNC:DOM ON

Query the open state of the marker search range of channel 2:

:CALC2:MARK:FUNC:DOM?

Query Response: {1|0}< newline><^END>

Related keys: Marker Search > Search Range > Search Range

◆ :CALC<CH>:MARK:FUNC:DOM:STAR

Command Type: Command/Query

Syntax:

:CALCulate<Ch>[:SELEcted]:MARKer:FUNctio:n:DOMain:STARt < number>

:CALCulate<Ch>[:SELEcted]:MARKer:FUNctio:n:DOMain:STARt?

Description: Set or query the start value of the marker search range

Parameters:

Parameter	Numerical Value
Description	Search range start value

Data Type	Double precision type (double)
Unit	Hz V A

Examples:

Set the search range start value of channel 1 to 1 kHz:

:CALC1:MARK:FUNC:DOM:STAR 1E3

Query the search range start value of channel 2:

:CALC2:MARK:FUNC:DOM:STAR?

Query Response: {< number>}<newline><<^END>

Related keys: Marker Search > Search Range > Start

◆ :CALC<Ch>:MARK:FUNC:DOM:STOP

Command Type: Command/Query

Syntax:

:CALCulate<Ch>[:SElected]:MARKer:FUNCTion:DOMain:STOP < number>

:CALCulate<Ch>[:SElected]:MARKer:FUNCTion:DOMain:STOP?

Description: Set or query the termination value of the marker search range

Parameters:

Parameter	Numerical Value
Description	Search range termination value
Data Type	Double precision type (double)
Unit	Hz V A

Examples:

Set the search range termination value of channel 1 to 1 MHz:

:CALC1:MARK:FUNC:DOM:STOP 1E6

Query the search range termination value of channel 2:

:CALC2:MARK:FUNC:DOM:STOP?

Query Response: {< number>}<newline><<^END>

Related keys: Marker Search > Search Range > Stop

◆ :CALC<Ch>:MARK<Mk>:FUNC:EXEC

Command Type: Command

Syntax:

:CALCulate<Ch>[:SElected]:MARKer<Mk>:FUNction:EXECute

Description: Immediately perform a marker search

Related keywords: [Marker Search](#) > [Max](#) | [Min](#) | [Peak](#) | [Target](#) | [Multi Peak](#) | [Multi Target](#)

◆ :CALC<Ch>:MARK:FUNC:MULT:PEXC

Command Type: Command/Query

Syntax:

:CALCulate<Ch>[:SElected]:MARKer:FUNction:MULTi:PEXCursion < number>

:CALCulate<Ch>[:SElected]:MARKer:FUNction:MULTi:PEXCursion?

Description: Set or query the multiple peak excursion of the selected channel

Parameters:

Parameter	Numerical Value
Description	Peak excursion
Data Type	Double precision type (double)
Range	0 - 1E15
Preset Value	3
Unit	Depends on measurement parameters

Examples:

Set the multiple peak excursion of channel 1 to 1kΩ:

:CALC1:MARK:FUNC:MULT:PEXC 1E3

Query the multiple peak excursion of channel 2:

:CALC2:MARK:FUNC:MULT:PEXC?

Query Response: <number><newline><^END>

Related keys: [Marker Search](#) > [Multi Peak](#) > [Peak Excursion](#)

◆ :CALC<Ch>:MARK:FUNC:MULT:PPOL

Command Type: Command/Query

Syntax:

:CALCulate<Ch>[:SElected]:MARKer:FUNCTion:MULTi:PPOLarity
{POSitive|NEGative|BOTH}

:CALCulate<Ch>[:SElected]:MARKer:FUNCTion:MULTi:PPOLarity?

Description: Set or query the peak polarity of the multiple peaks of the selected channel

Parameters:

Parameter	Selection Option
Description	Peak polarity
Data Type	Character string type (String)
Range	POSitive NEGative BOTH
Preset Value	BOTH

Examples:

Set the multiple peak polarity of channel 1 to peak: :CALC1:MARK:FUNC:MULT:PPOL POS

Query the multiple peak polarity of channel 2: :CALC2:MARK:FUNC:MULT:PPOL?

Query Response: {POS|NEG|BOTH}< newline><^END>

Related keys: [Marker Search](#) > [Multi Peak](#) > [Peak Polarity](#)

◆ :CALC<Ch>:MARK:FUNC:MULT:TARG

Command Type: Command/Query

Syntax:

:CALCulate<Ch>[:SElected]:MARKer:FUNCTion:MULTi:TARGet < number>

:CALCulate<Ch>[:SElected]:MARKer:FUNCTion:MULTi:TARGet?

Description: Set and query the target value of the multiple target values of the selected channel

Parameter:

Parameter	Numerical Value
Description	Target value
Data Type	Double precision type (double)
Range	-1E15 - 1E15
Preset Value	0

Unit	Depends on measurement parameters
------	-----------------------------------

Examples:

Set the target of the multiple target value of channel 1 to 1kΩ:

:CALC1:MARK:FUNC:MULT:TARG 1E3

Query the target of the multiple target values of channel 2:

:CALC2:MARK:FUNC:MULT:TARG?

Query Response: <number><newline><^END>

Related keys: Marker Search > Multi Target > Target

◆ :CALC<Ch>:MARK:FUNC:MULT:TTR

Command Type: Command/Query

Syntax:

:CALCulate<Ch>[:SElected]:MARKer:FUNction:MULTi:TTRansition
{POSitive|NEGative|BOTH}

:CALCulate<Ch>[:SElected]:MARKer:FUNction:MULTi:TTRansition?

Description: Set or query the transition of the multiple target values of the selected channel

Parameters:

Parameter	Selection Option
Description	Target transition
Data Type	Character string type (String)
Range	POSitive NEGative BOTH
Preset Value	BOTH

Examples:

Set the transition of the multiple target value of channel 1 to positive:

:CALC1:MARK:FUNC:MULT:TTR POS

Query the transition of the multiple target value of channel 2:

:CALC2:MARK:FUNC:MULT:TTR?

Query response: {POS|NEG|BOTH}<newline><^END>

Related keys: **Marker Search** > **Multi Target** > **Target Transition**

◆ :CALC<Ch>:MARK:FUNC:MULT:TYPE

Command Type: Command/Query

Syntax:

:CALCulate<Ch>[:SElected]:MARKer:FUNctiOn:MULTi:TYPE {OFF|PEAK|TARGet}

:CALCulate<Ch>[:SElected]:MARKer:FUNctiOn:MULTi:TYPE?

Description: Set or query whether the marker search of the current channel is multiple search

Parameters:

Parameter	Selection Option
Description	Multiple search
Data Type	Character string type (String)
Range	OFF PEAK TARGet
Preset Value	BOTH

Examples:

Set the marker search of channel 1 to multiple peak:

:CALC1:MARK:FUNC:MULT:TYPE PEAK

Query whether the channel 2 is multiple marker search:

:CALC2:MARK:FUNC:MULT:TYPE?

Query Response: {OFF|PEAK|TARG} < newline > ^END <

◆ :CALC<Ch>:MARK<Mk>:FUNC:PEXC

Command Type: Command/Query

Syntax:

:CALCulate<Ch>[:SElected]:MARKer<Mk>:FUNctiOn:PEXCursion < number >

:CALCulate<Ch>[:SElected]:MARKer<Mk>:FUNctiOn:PEXCursion?

Description: Set or query the peak excursion of the selected marker of the selected channel

Parameters:

Parameter	Numerical Value
Description	Peak excursion

Data Type	Double precision type (double)
Range	0 - 1E15
Preset Value	3
Unit	Depends on measurement parameters

Examples:

Set the peak excursion of channel 1 marker 1 to 1kΩ:

:CALC1:MARK1:FUNC:PEXC 1E3

Query the peak excursion of channel 2 marker 2:

:CALC2:MARK2:FUNC:PEXC?

Query Response: <number><newline><^END>

Related keys: [Marker Search](#) > [Peak](#) > [Peak Excursion](#)

◆ :CALC<Ch>:MARK<Mk>:FUNC:PPOL

Command Type: Command/Query

Syntax:

:CALCulate<Ch>[:SELEcted]:MARKer<Mk>:FUNCtion:PPOLarity
{POSitive|NEGative|BOTH}

:CALCulate<Ch>[:SELEcted]:MARKer<Mk>:FUNCtion:PPOLarity?

Description: Set or query the peak polarity of the selected marker peak of the selected channel

Parameters:

Parameter	Selection Option
Description	Peak polarity
Data Type	Character string type (String)
Range	POSitive NEGative BOTH
Preset Value	BOTH

Examples:

Set the peak polarity of the channel 1 marker to peak:

:CALC1:MARK1:FUNC:PPOL POS

Query the peak polarity of channel 2 marker 2:

:CALC2:MARK2:FUNC:PPOL?

Query Response: {POS|NEG|BOTH}< newline><^END>

Related keys: Marker Search > Peak > Peak Polarity

◆ :CALC<Ch>:MARK<Mk>:FUNC:TARG

Command Type: Command/Query

Syntax:

:CALCulate<Ch>[:SElected]:MARKer<Mk>:FUNCtion:TARGet < number>

:CALCulate<Ch>[:SElected]:MARKer<Mk>:FUNCtion:TARGet?

Description: Set and query the target value of the selected marker of the selected channel

Parameters:

Parameters	Numerical Value
Description	Target value
Data Type	Double precision type (double)
Range	-1E15 - 1E15
Preset Value	0
Unit	Depends on measurement parameters

Examples:

Set the target of channel 1 marker 1 target value to 1kΩ:

:CALC1:MARK1:FUNC:TARG 1E3

Query the target of channel 2 marker 2 target value:

:CALC2:MARK2:FUNC:TARG?

Query Response: <number><newline><^END>

Related keys: Marker Search > Target > Target

◆ :CALC<Ch>:MARK<Mk>:FUNC:TRAC

Command Type: Command/Query

Syntax:

:CALCulate<Ch>[:SElected]:MARKer<Mk>:FUNCtion:TRACking {ON|OFF|1|0}

:CALCulate<Ch>[:SElected]:MARKer<Mk>:FUNCtion:TRACking?

Description: Set or query the open state of the marker tracking function of the selected marker of the selected channel. When the marker tracking is turned on, the marker will perform a marker search immediately after each sweep cycle is completed

Parameters:

Parameter	Selection Option
Description	Marker tracking state
Data Type	Boolean type (Boolean)
Range	ON OFF 1 0
Preset Value	OFF

Examples:

Turn on the marker tracking of channel 1 marker 1:

:CALC1:MARK1:FUNC:TRAC ON

Query the open state of the marker tracking of channel 2 marker 2:

:CALC2:MARK2:FUNC:TRAC?

Query Response: {1|0}< newline><^END>

Related keys: Marker Search > Tracking

◆ :CALC<Ch>:MARK<Mk>:FUNC:TTR

Command Type: Command/Query

Syntax:

:CALCulate<Ch>[:SELEcted]:MARKer<Mk>:FUNCtion:TTRansition
{POSitive|NEGative|BOTH}

:CALCulate<Ch>[:SELEcted]:MARKer<Mk>:FUNCtion:TTRansition?

Description: Set or query the transition of the target value of the selected marker of the selected channel

Parameters:

Parameter	Selection Option
Description	Target transition
Data Type	Character string type (String)
Range	POSitive NEGative BOTH
Preset Value	BOTH

Examples:

Set the target transition of channel 1 marker 1 to Positive:

:CALC1:MARK1:FUNC:TTR POS

Query the target transition of channel 2 marker 2:

:CALC2:MARK2:FUNC:TTR?

Query Response: {POS|NEG|BOTH}< newline><^END>

Related keys: [Marker Search](#) > [Target](#) > [Target Transition](#)

◆ :CALC<Ch>:MARK<Mk>:FUNC:TYPE

Command Type: Command/Query

Syntax:

:CALCulate<Ch>[:SElected]:MARKer<Mk>:FUNCtion:{MAXimum|MINimum|PEAK|LPEak|RPEak|TARGet|LTARget|RTARget}

:CALCulate<Ch>[:SElected]:MARKer<Mk>:FUNCtion:TYPE?

Description: Set or query the mode of the current marker search

Parameters:

Parameter	Selection Option
Description	Marker search mode
Data Type	Character string type (String)
Range	MAXimum: Search maximum value MINimum: Search minimum value PEAK: Search peak value LPEak: Search left peak value RPEak: Search right peak value TARGet: Search target value LTARget: Search left target value RTARget: Search right target value
Preset Value	BOTH

Examples:

Set the marker search mode of channel 1 to search maximum:

:CALC1:MARK:FUNC:TYPE MAX

Query the marker search mode of channel 2:

:CALC2:MARK:FUNC:TYPE?

Query Response: {MAX|MIN|PEAK|LPE|RPE|TARG|LTAR|RTAR}< newline><^END>

Related keys: [Marker Search](#) > [Max](#) | [Min](#) | [Target](#) | [Peak](#)

◆ :CALC<Ch>:MARK:MATH:STAT

Command Type: Command/Query

Syntax:

:CALCulate<Ch>[:SElected]:MARKer:MATH:STATistics[:STATe] {ON|OFF|1|0}

:CALCulate<Ch>[:SElected]:MARKer:MATH:STATistics[:STATe]?

Description: Set or query the open state of the marker statistics

Parameters:

Parameter	Selection Option
Description	Marker statistics state
Data Type	Boolean type (Boolean)
Range	ON OFF 1 0
Preset Value	OFF

Examples:

Turn on the marker statistics state of channel 1:

:CALC1:MARK:MATH:STAT ON

Query the on-off state of the marker statistics of channel 2:

:CALC2:MARK:MATH:STAT?

Query Response: {1|0}< newline><^END>

Related keys: [Marker Function](#) > [Statistics](#)

◆ :CALC<Ch>:MARK:MATH:STAT:DATA

Command Type: Query

Syntax:

:CALCulate<Ch>[:SElected]:MARKer:MATH:STATistics:DATA?

Description: Query the current statistics data

Query Response: {< number1>},{< number2>},{< number3>},{<

number4>}<newline><^END>

< Number 1>: Range span

< Number 2>: Average value

< Number 3>: Standard deviation

< Number 4>: Peak-to-peak value

◆ :CALC<Ch>:MARK:REF

Command Type: Command/Query

Syntax:

:CALCulate<Ch>[:SElected]:MARKer:REFerence[:STATe] {ON|OFF|1|0}

:CALCulate<Ch>[:SElected]:MARKer:REFerence[:STATe]?

Description: Set or query the on-off state of the reference marker of the selected channel

Parameters:

Parameter	Selection Option
Description	Reference marker state
Data Type	Boolean type (Boolean)
Range	ON OFF 1 0
Preset Value	OFF

Examples:

Turn on the reference marker of channel 1:

:CALC1:MARK:REF ON

Query the on-off state of the reference marker of channel 2:

:CALC2:MARK:REF?

Query Response: {1|0}< newline><^END>

Related keys: [Marker](#) > [Ref Marker Mode](#)

◆ :CALC<Ch>:MARK<Mk>:SET

Command Type: Command

Syntax:

:CALCulate<Ch>[:SELEcted]:MARKer<Mk>:SET {CENTer|STARt|STOP|RLEVel|ZOOM}

Description: Set the position of the selected marker of the selected channel to the Stimulus

Parameters:

Parameter	Selection Option
Description	Stimulus type
Data Type	Character string type (String)
Range	START: Set the marker position to the stimulus start value STOP: Set the marker position to the stimulus termination value CENTer: Set the marker position to the stimulus center value RLEVel: Set the marker value to the reference value of the response value ZOOM: Zoom the horizontal axis according to the set zoom ratio

Examples:

Set the position of channel 1 marker 1 to the stimulus center value:

:CALC1:MARK1:SET CENT

Related keys: **Marker Function** > Marker→Start | Marker→Stop | Marker→Center | Marker→Reference | Marker Zoom

◆ :CALC<Ch>:MARK<Mk>:X

Command Type: Command/Query

Syntax:

:CALCulate<Ch>[:SELEcted]:MARKer<Mk>:X[:DATA] < number>

:CALCulate<Ch>[:SELEcted]:MARKer<Mk>:X[:DATA]?

Description: Set or query the stimulus value of the selected marker of the selected channel

Examples:

Set the stimulus value of channel 1 marker 1 to 1 MHz:

:CALC1:MARK1:X 1E6

Query the stimulus value of channel 2 marker 2:

:CALC2:MARK2:X?

Query Response: <number><newline><^END>

Related keys: **Marker** > **Marker1 - Marker9** | **Ref Marker**

◆ :CALC<Ch>:MARK<Mk>:X:POS

Command Type: Command/Query

Syntax:

:CALCulate<Ch>[:SElected]:MARKer<Mk>:X:POSition < number>

:CALCulate<Ch>[:SElected]:MARKer<Mk>:X:POSition?

Description: Set or query the position of the selected marker of the selected channel relative to the measurement point

Parameters:

Parameter	Numerical Value
Description	Measurement point position value
Data Type	Double precision type (double)
Range	1 - Number of measurement points
Preset Value	1

Examples:

Set the position of channel 1 marker 1 to 100:

:CALC1:MARK1:X:POS 100

Query the position of channel 2 marker 2:

:CALC2:MARK2:X:POS?

Query Response: <number><newline><^END>

◆ :CALC<Ch>:MARK<Mk>:Y

Command Type: Query

Syntax:

:CALCulate<Ch>[:SElected]:MARKer<Mk>:Y?

Description: Query the measured (response) value of the selected marker of the selected channel

Query Response: <number><newline><^END>

◆ :CALC<Ch>:MARK:ZAP

Command Type: Command/Query

Syntax:

:CALCulate<Ch>[:SElected]:MARKer:ZAPerture < number>

:CALCulate<Ch>[:SElected]:MARKer:ZAPerture?

Description: Set or query the marker zooming aperture of the selected channel

Parameters:

Parameter	Numerical Value
Description	Zooming aperture
Data Type	Double precision type (double)
Range	0.01 - 100
Preset Value	10
Unit	%

Examples:

Set the zooming aperture of channel 1 to 20%:

:CALC1:MARK:ZAP 20

Query the zooming aperture of channel 1:

:CALC2:MARK:ZAP?

Query Response: <number><newline><^END>

Related keys: Marker Function > Zooming Aperture

◆ :CALC<Ch>:MATH:FUNC

Command Type: Command/Query

Syntax:

:CALCulate<Ch>[:SElected]:MATH:FUNCTION
{NORMAL|DIVide|MULTiply|SUBTract|ADD}

:CALCulate<Ch>[:SElected]:MATH:FUNCTION?

Description: Set or query the data math mode of the selected channel. When the memory trace of the trace does not exist, only NORMAL can be set; when the number of measurement points of the channel is changed, the value is automatically modified to NORMAL

Parameters:

Parameter	Selection Option
Description	Data math type
Data Type	Character string type (String)
Range	NORMAL: DATA (no arithmetic) DIVide: DATA/MEM MULTiply: DATA *MEM SUBTract: DATA-MEM ADD: DATA+MEM DATA refers to the data in the measurement trace, MEM refers to the data in the memory trace
Preset Value	NORMAL

Examples:

Set the data math for the currently selected trace of channel 1 to ADD:

```
:CALC1:MATH:FUNC ADD
```

Query the data math for the currently selected trace of channel 2:

```
:CALC2:MATH:FUNC?
```

Query Response: {NORM|DIV|MULT|SUBT|ADD}< newline><^END>

Related keys: Display > Data Math

◆ :CALC<Ch>:MATH:MEM

Command Type: Command

Syntax: :CALCulate<Ch>[:SElected]:MATH:MEMorize

Description: Copy the measurement data of the current trace of the selected channel to the corresponding memory trace

Related keys: Display > Data→Mem

◆ :CALC<Ch>:MATH:OFFS

Command Type: Command/Query

Syntax:

```
:CALCulate<Ch>[:SElected]:MATH:OFFSet < number>
```

```
:CALCulate<Ch>[:SElected]:MATH:OFFSet?
```

Description: Set or query the data math offset of the current trace of the selected channel

Parameters:

Parameter	Numerical Value
Description	Data math offset
Data Type	Double precision type (double)
Range	-1E15 - 1E15
Preset Value	0
Unit	Depends on measurement parameters

Examples:

Set the offset of the current trace of channel 1 to 1k:

:CALC1:MATH:OFFS 1E3

Query the offset of the current trace of channel 2:

:CALC2:MATH:OFFS?

Query Response: <number><newline><^END>

Related keys: Display > Data Math Offset

◆ :CALC<Ch>:MST

Command Type: Command/Query

Syntax:

:CALCulate<Ch>[:SElected]:MSTatistics[:STATe] {ON|OFF|1|0}

:CALCulate<Ch>[:SElected]:MSTatistics[:STATe]?

Description: Set or query the on-off state of the statistics of the selected channel

Parameters:

Parameter	Selection Option
Description	Statistics state
Data Type	Boolean type (Boolean)
Range	ON OFF 1 0
Preset Value	OFF

Examples:

Turn on the statistics of channel 1:

:CALC1:MST ON

Query the on-off state of the statistic of channel 2:

:CALC2:MST?

Query Response: {1|0}< newline><^END>

Related keys: [Marker Function](#) > [Statistics](#)

◆ :CALC<Ch>:MST:DATA

Command Type: Query

Syntax:

:CALCulate<Ch>[:SElected]:MSTatistics:DATA?

Description: Query the statistical values of the selected channel

Query Response: {< number1> },{< number2> },{< number3> },{< number4> }<newline><^END>

< Number 1>: Range span

< Number 2>: Average value

< Number 3>: Standard deviation

< Number 4> : Peak-to-peak value

◆ :CALC<Ch>:OSCA:DATA

Command Type: Query

Syntax:

:CALCulate<Ch>:OSweepalysis:DATA?

Description: Query the parameters of OSC analysis of the selected channel

Parameters:

Parameter	Numerical Value
Description	OSC analysis parameters The query returns 18 values, the meaning of each value is as follows: < Number 1>: Free capacitance Ct < Number 2>: Free loss Dt < Number 3>: Resonance frequency Fs < Number 4>: Anti-resonance frequency Fp < Number 5>: Impedance minimum Zmin

	< Number 6>: Impedance maximum Zmax < Number 7>: Conductance maximum Gmax < Number 8>: Half-power point frequency F1 < Number 9>: Half-power point frequency F2 < Number 10>: Direct capacitance C0 < Number 11>: Dynamic capacity C1 < Number 12>: Dynamic resistance R1 < Number 13>: Dynamic inductance L1 < Number 14>: Phase angle maximum θ_{max} < Number 15>: Phase angle maximum point frequency θ_{max} Frequency < Number 16>: Phase angle maximum point impedance θ_{max} Resistance < Number 17>: Phase angle maximum point capacitance θ_{max} Capacity < Numeral 18>: Electromechanical coupling coefficient Kt < Number 19>: Quality factor Qm
Data Type	Double precision type (double)

Query Response: {< number 1>},{< number 2>}...{< number 18>}<newline><^END>

◆ :CALC<Ch>:OSCA:EQUA

Command Type: Command/Query

Syntax:

:CALCulate<Ch>:OSweepalysis:EQUation {1|2}

:CALCulate<Ch>:OSweepalysis:EQUation?

Description: Set or query the equation of calculating the quality factor Qm in the OSC analysis of the selected channel

Parameters:

Parameter	Numerical Value
Description	Equation serial number
Data Type	Numeric type (Integer)
Range	1 2 $1: Q_m = \frac{F_s}{F_2 - F_1}$ $2: Q_m = \frac{F_p^2}{2\pi F_s R C_t (F_p^2 - F_s^2)}$

	In the above equation: Qm: Quality factor Fs: Resonance frequency F1, F2: Half-power point and $F2 > F1$ Fp: Anti-resonance frequency R: Impedance min. Ct: Free capacitance
Preset Value	1

Examples:

Set the Qm calculation equation of channel 1 to equation 1:

:CALC1:OSCA:EQUA 1

Query the Qm equation of channel 2:

:CALC2:OSCA:EQUA?

Query Response: {1|2}< newline><^END>

Related keys: [Analysis](#) > [OSC Analysis](#) > [Q Equation](#)

◆ :CALC<Ch>:OSCA:STAT

Command Type: Command/Query

Syntax:

:CALCulate<Ch>:OSweepalysis:STATe {ON|OFF|1|0}

:CALCulate<Ch>:OSweepalysis:STATe?

Description: Set or query the OSC analysis state of the selected channel, and it is effective only when the sweep mode of the selected channel is sweep

Parameters:

Parameter	Selection Option
Description	OSC analysis state
Data Type	Boolean type (Boolean)
Range	ON OFF 1 0
Preset Value	OFF

Examples:

Turn on the OSC analysis of channel 1:

:CALC1:OSCA:STAT ON

Query the on-off state of the OSC analysis of channel 2:

:CALC2:OSCA:STAT?

Query Response: {1|0}< newline><^END>

Related keys: **Analysis** > **OSC Analysis** > **State**

◆ :CALC<Ch>:PAR:COUN

Command Type: Command/Query

Syntax:

:CALCulate<Ch>:PARAmeter:COUNT <number>

:CALCulate<Ch>:PARAmeter:COUNT?

Description: Set or query the number of traces of the selected channel

Parameters:

Parameters	Numerical Value
Description	Number of traces
Data Type	Numeric type (Integer)
Range	1 2 3 4
Preset Value	2

Examples:

Set the number of traces of channel 1 to 4:

:CALC1:PAR:COUN 4

Query the number of traces of channel 2:

:CALC2:PAR:COUN?

Query Response: {1|2|3|4}< newline><^END>

Related keys: **Display** > **Num of Traces**

◆ :CALC<Ch>:PAR<Tr>:DEF

Command Type: Command/Query

Syntax:

:CALCulate<Ch>:PARAmeter<Tr>:DEFine

{Z|Y|R|X|G|B|LS|LP|CS|CP|RS|RP|Q|D|TZR|TZD|TYR |TYD|VAC|IAC}

:CALCulate<Ch>:PARAmeter<Tr>:DEFine?

Description: Set or query the measurement parameters of the selected trace of the selected channel

Parameters:

Parameter	Selection Option
Description	Sweep measurement parameters
Data Type	Character string type (String)
Range	Z: Absolute impedance value Y: Absolute admittance value TZR: Impedance phase (radian) TZD: Impedance phase (angle) TYR: admittance phase (radian) TYD: admittance phase (angle) RS: Equivalent circuit series resistance RP: Equivalent circuit parallel resistance LS: Equivalent circuit series inductance LP: Equivalent circuit parallel inductance CS: Equivalent circuit series capacitance CP: Equivalent circuit parallel capacitance R: Equivalent circuit resistance G: Equivalent circuit conductance X: Equivalent circuit reactance B: Equivalent circuit susceptance Q: Quality factor D: Dissipation factor VAC: Signal source AC voltage IAC: Signal source AC current ER: Relative permittivity $ \epsilon_r $ (requires permittivity module support) ER1: Relative permittivity real part ϵ_r' (requires permittivity module support) ER2: Relative permittivity imaginary part ϵ_r'' (requires permittivity module support) U1: Complex permeability real part μ' (requires troidalcore module support) U2: Complex permeability imaginary part μ'' (requires troidalcore module support) TAN: Phase $\tan \delta$ (requires troidalcore module support)

Examples:

Set the measurement parameters of channel 1 trace 1 to the equivalent series resistance:

:CALC1:PAR1:DEF RS

Query the measurement parameters of channel 2 trace 2:

:CALC2:PAR2:DEF?

Query Response:

{Z|Y|R|X|G|B|LS|LP|CS|CP|RS|RP|Q|D|TZR|TZD|TYR|TYD|VAC|IAC|ER|ER1|ER2|U1|U2|TAN}
<newline> <^END>

Related keys: **Meas** > Trace1 | Trace2 | Trace3 | Trace4

◆ :CALC<Ch>:PAR<Tr>:SEL

Command Type: Command

Syntax:

:CALCulate<Ch>:PARAmeter<Tr>:SELect

Description: Set the selected trace of the selected channel as the active trace

Examples:

Set the channel 1 trace 1 as the active trace: :CALC1:PAR1:SEL

◆ :CALC<Ch> :PERM:A1

Command Type: Command/Query

Syntax:

:CALCulate<Ch>:PERMittivity:A1 {ON|OFF|1|0}

:CALCulate<Ch>:PERMittivity:A1?

Description: Set or query the electrode in the calculation of the permittivity of the selected channel; this command must be enabled with the permittivity permission before it can be used.

Parameters:

Parameter	Selection Option
Description	Display
Data Type	Boolean type (Boolean)
Range	ON OFF 1 0
Command	ON: Electrode is A1 OFF: Electrode is A2
Preset Value	ON

Examples:

Set the electrode of channel 1 to A1: :CALC1:PERM:A1 ON

Query the electrode of channel 2: :CALC2:PERM:A1?

Query Response: {1|0}< newline><^END>

Related keys: **Meas** > **Electrode**

◆ :CALC<Ch> :PERM:THIC

Command Type: Command/Query

Syntax:

:CALCulate<Ch>:PERMittivity:THICkness <number>

:CALCulate<Ch>:PERMittivity:THICkness?

Description: Set or query the thickness in the calculation of the permittivity of the selected channel; this command must be enabled with the permittivity permission before it can be used.

Parameters:

Parameter	Numerical Value
Description	Thickness
Data Type	Double precision type (double)
Range	1E-9 - 999
Unit	m
Preset Value	0.01

Examples:

Set the thickness of channel 1 to 5 mm:

:CALC1:PERM:THIC 5E-3

Query the thickness of channel 2:

:CALC2:PERM:THIC?

Query Response: {< number>}<newline><^END>

Related keys: **Meas** > **Thickness**

◆ :CALC<Ch> :TROI:HEIG

Command Type: Command/Query

Syntax:

:CALCulate<Ch> :TROIalcore:HEIGHt?

:CALCulate<Ch> :TROIalcore:HEIGHt <number>

Description: Set and query the troidal core height in the calculation of the troidalcore of the selected channel; this command must be enabled with the troidalcore permission before it can be

used.

Parameters:

Parameter	Numerical Value
Description	Troidal core height
Data Type	Double precision type (double)
Range	1e-9 - 999
Preset Value	0.005
Unit	m

Examples:

Set the troidal core height of channel 1 to 10mm:

:CALC1:TROI:HEIG 0.01

Query the troidal core height of channel 2:

:CALC2:TROI:HEIG?

Query Response: {< number>}<newline><^END>

Related keys: [Meas](#) > [Troidal Core Height](#)

◆ :CALC<Ch> :TROI:INN

Command Type: Command/Query

Syntax:

:CALCulate<Ch> :TROI:INNer?

:CALCulate<Ch> :TROI:INNer <number>

Description: Set and query the troidal core inner in the calculation of the troidalcore of the selected channel; this command must be enabled with the troidalcore permission before it can be used.

Parameters:

Parameter	Numerical Value
Description	Troidal core inner
Data Type	Double precision type (double)
Range	1e-9 - 999
Preset Value	0.008
Unit	m

Examples:

Set the troidal core inner of channel 1 to 10 mm:

:CALC1:TROI:INN 0.01

Query the troidal core inner of channel 2:

:CALC2:TROI:INN?

Query Response: {< number>}<newline><^END>

Related keys: Meas > Troidal Core Inner

◆ :CALC<Ch> :TROI:OUT

Command Type: Command/Query

Syntax:

:CALCulate<Ch> :TROI:OUTer?

:CALCulate<Ch> :TROI:OUTer <number>

Description: Set and query the troidal core outer in the calculation of the troidalcore of the selected channel; this command must be enabled with the troidalcore permission before it can be used.

Parameters:

Parameter	Numerical Value
Description	Troidal core outer
Data Type	Double precision type (double)
Range	1e-9 - 999
Preset Value	0.015
Unit	m

Examples:

Set the troidal core outer of channel 1 to 20mm:

:CALC1:TROI:OUT 0.02

Query the troidal core outer of channel 2:

:CALC2:TROI:OUT?

Query Response: {< number>}<newline><^END>

Related keys: Meas > Troidal Core Outer

9.2.5.3 DISPLAY

◆ :DISP:MAX

Command Type: Command/Query

Syntax:

:DISPlay:MAXimize {ON|OFF|1|0}

:DISPlay:MAXimize?

Description: Set or query whether the currently selected channel is in the maximum display state. When the display is maximized, only the selected channel will be displayed on the measurement screen.

Parameters:

Parameter	Selection Option
Description	Channel maximization display
Data Type	Boolean type (Boolean)
Range	ON OFF 1 0
Preset Value	OFF

Examples:

Turn on the current channel maximization display:

:DISP:MAX ON

Query Response: {1|0}< newline><^END>

Related keys: Channel Max

◆ :DISP:SPL

Command Type: Command/Query

Syntax:

:DISPlay:SPLit {D1|D1_2|D12|D1_2_3|D12_34|D1_1_2|D112|D12_33|D13_23|D123|D11_23|D12_13|D1234|D1_2_3_4}

:DISPlay:SPLit?

Description: Set or query the channel distribution method

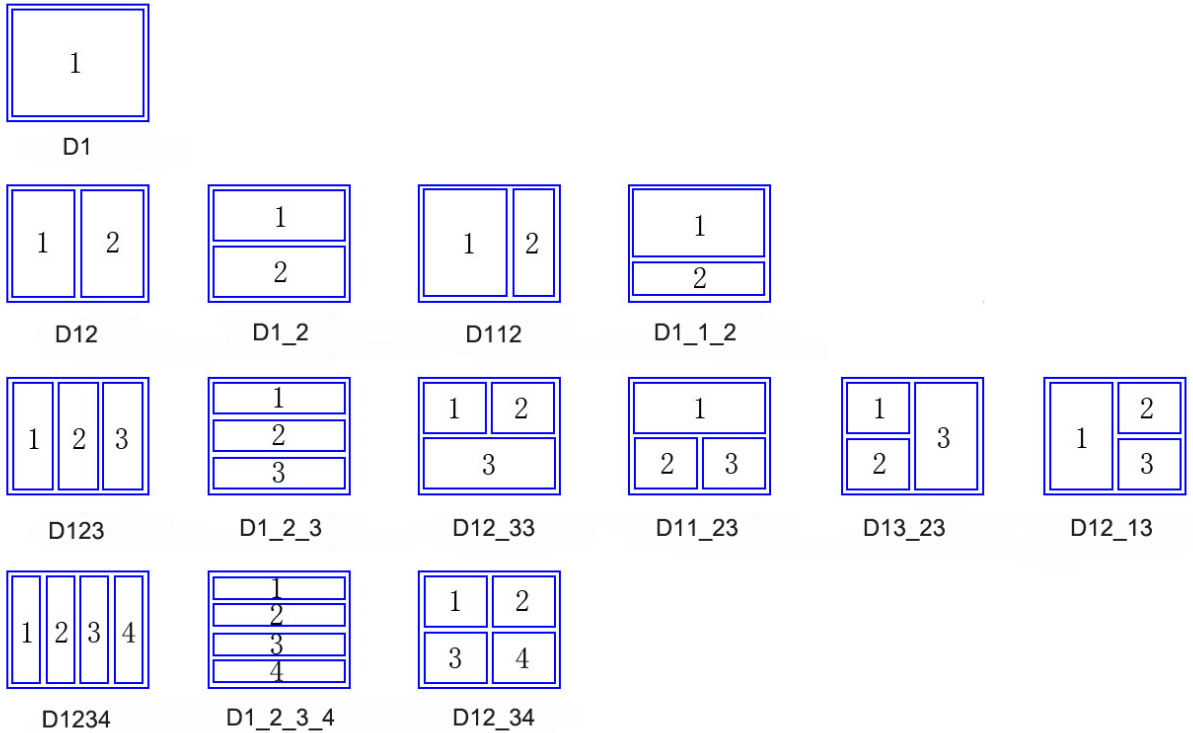

Parameters:

Parameter	Selection Option
Description	Channel distribution type
Data Type	Character string type (String)
Range	D1 D1_2 D12 D1_2_3 D12_34 D1_1_2 D112 D12_33 D13_23 D123 D11_23 D12_13 D1234 D1_2_3_4
Preset Value	D1

Examples:

Set the channel distribution to D12:

```
:DISP:SPL D12
```

Query the channel distribution:

```
:DISP:SPL?
```

Query Response:

```
{D1|D1_2|D12|D1_2_3|D12_34|D1_1_2|D112|D12_33|D13_23|D123|D11_23|D12_13|D1234|D1_2_3_4}< newline><^END>
```

Related keys: **Display** > **Allocate Channels**

◆ :DISP:WIND<Ch>:ACT

Command Type: Command

Syntax:

:DISPlay:WINDow<Ch>:ACTivate

Description: Set the selected channel as the active channel. Only the currently displayed channel can be set, otherwise an error will be returned.

Related keys: Channel Prev | Channel Next

◆ :DISP:WIND<Ch>:LAB

Command Type: Command/Query

Syntax:

:DISPlay:WINDow<Ch>:LABel {ON|OFF|1|0}

:DISPlay:WINDow<Ch>:LABel?

Description: Set or query the on-off state of the display of the Y-axis label of the measurement coordinate system

Parameters:

Parameter	Selection Option
Description	Label display
Data Type	Boolean type (Boolean)
Range	ON OFF 1 0
Preset Value	ON

Examples:

Turn on the Y-axis label display of channel 1:

:DISP:WIND1 ON

Query Response: {1|0}< newline><^END>

Related keys: Display > Graticule Label

◆ :DISP:WIND<Ch>:MAX

Command Type: Command/Type

Syntax:

:DISPlay:WINDow<Ch>:MAXimize {ON|OFF|1|0}

:DISPlay:WINDow<Ch>:MAXimize?

Description: Set or query whether the active trace of the currently selected channel is in the

maximum display state. When it is in the maximum display, only the active traces will be displayed on the channel interface

Parameters:

Parameter	Selection Option
Description	Trace maximization display
Data Type	Boolean type (Boolean)
Range	ON OFF 1 0
Preset Value	OFF

Examples:

Turn on the trace maximization display of channel 1:

:DISP:WIND1:MAX ON

Query Response: {1|0}< newline><^END>

Related keys: Trace Max

◆ :DISP:WIND<Ch>:SPL

Command Type: Command/Query

Syntax:

:DISPlay:WINDow<Ch>:SPLit
 {D1|D1_2|D12|D1_2_3|D12_34|D1_1_2|D112|D12_33|D13_23| D123|D11_23|
 D12_13|D1234|D1_2_3_4}

:DISPlay:WINDow<Ch>:SPLit?

Description: Set or query the distribution methods of traces in the selected channel

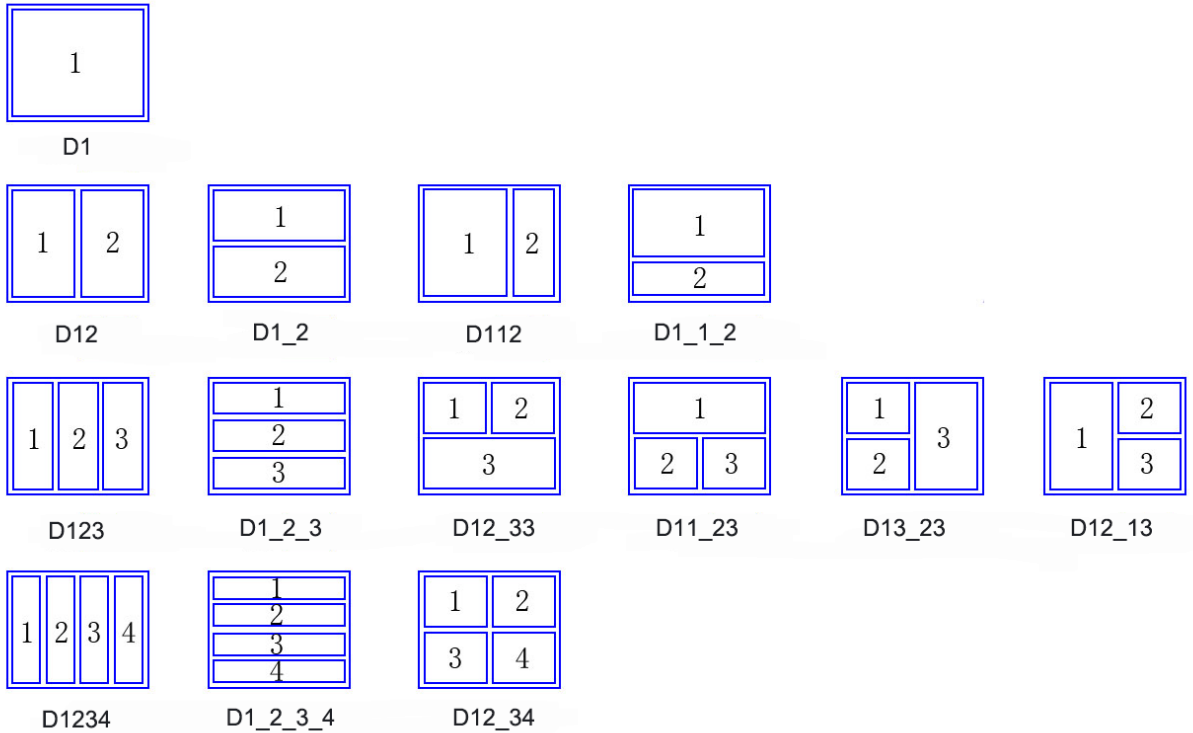

Parameters:

Parameter	Selection Option
Description	Trace distribution type
Data Type	Character string type (String)
Range	D1 D1_2 D12 D1_2_3 D12_34 D1_1_2 D112 D12_33 D13_23 D123 D11_23 D12_13 D1234 D1_2_3_4
Preset Value	D1

Examples:

Set the trace distribution of channel 1 to D12:

```
:DISP:WIND1:SPL D12
```

Query the trace distribution of channel 2:

```
:DISP:WIND2:SPL?
```

Query Response:

```
{D1|D1_2|D12|D1_2_3|D12_34|D1_1_2|D112|D12_33|D13_23|D123|D11_23|D12_13|D1234|D1_2_3_4}< newline><^END>
```

Related keys: **Display** > **Allocate Trace**

◆ :DISP:WIND<Ch>:TRAC<Tr>:DATA

Command Type: Command/Query

Syntax:

:DISPlay:WINDow<Ch>:TRACe<Tr>:DATA[:STATe] {ON|OFF|1|0}

:DISPlay:WINDow<Ch>:TRACe<Tr>:DATA[:STATe]?

Description: Set or query the on-off state of the data trace of the selected trace of the selected channel

Parameters:

Parameter	Selection Option
Description	Data trace display
Data Type	Boolean type (Boolean)
Range	ON OFF 1 0
Preset Value	ON

Examples:

Turn on the data trace display of channel 1 trace 1:

:DISP:WIND1:TRAC1:DATA ON

Query the data trace display state of channel 2 trace 2:

:DISP:WIND1:TRAC1:DATA?

Query Response: {1|0}< newline><^END>

Related keys: Display > Display

◆ :DISP:WIND<Ch>:TRAC<Tr>:MEM

Command Type: Command/Query

Syntax:

:DISPlay:WINDow<Ch>:TRACe<Tr>:MEMory[:STATe] {ON|OFF|1|0}

:DISPlay:WINDow<Ch>:TRACe<Tr>:MEMory[:STATe]?

Description: Set or query the on-off state of the memory trace of the selected trace of the selected channel

Parameters:

Parameter	Selection Option
Description	Memory trace display
Data Type	Boolean type (Boolean)
Range	ON OFF 1 0

Preset Value	OFF
--------------	-----

Examples:

Turn on the memory trace display of channel 1 trace 1:

:DISP:WIND1:TRAC1:MEM ON

Query the memory trace display state of channel 2 trace 2:

:DISP:WIND1:TRAC1:MEM?

Query Response: {1|0}< newline><^END>

Related keys: Display > Display

◆ :DISP:WIND<Ch>:TRAC<Tr>:Y:AUTO

Command Type: Command

Syntax:

:DISPlay:WINDow<Ch>:TRACe<Tr>:Y[:SCALe]:AUTO

Description: Automatically scale the Y axis of the selected trace of the selected channel

Related keys: Scale > Auto Scale

◆ :DISP:WIND<Ch>:TRAC<Tr>:Y:BOTT

Command Type: Command/Query

Syntax:

:DISPlay:WINDow<Ch>:TRACe<Tr>:Y[:SCALe]:BOTTom < number>

:DISPlay:WINDow<Ch>:TRACe<Tr>:Y[:SCALe]:BOTTom?

Description: Set or query the minimum value of the selected trace of the selected channel when the vertical coordinate is logarithmic axis. This command will only be responded to when the vertical coordinate is logarithmic

Parameters:

Parameter	Numerical Value
Description	Logarithmic minimum value
Data Type	Double precision type (double)
Range	1E-18 - 1E15
Preset Value	10

Unit	Depends on measurement parameters
------	-----------------------------------

Examples:

Set the lower limit of the logarithmic axis of channel 1 trace 1 to 1000:

:DISP:WIND1:TRAC1:Y:BOTT 1E3

Query the lower limit of the logarithmic axis of channel 2 trace 2:

:DISP:WIND2:TRAC2:Y:BOTT?

Query Response: {< number>}<newline><^END>

Related keys: **Scale** > **Log-Y Bottom**

◆ :DISP:WIND<Ch>:TRAC<Tr>:Y:PDIV

Command Type: Command/Query

Syntax:

:DISPlay:WINDow<Ch>:TRACe<Tr>:Y[:SCALe]:PDIVision < number>

:DISPlay:WINDow<Ch>:TRACe<Tr>:Y[:SCALe]:PDIVision?

Description: Set or query the scale of each region of the selected trace of the selected channel when the vertical coordinate is linear axis. This command will only be responded to when the vertical coordinate is linear

Parameters:

Parameter	Numerical Value
Description	Division scale
Data Type	Double precision type (double)
Range	1E-18 - 1E15
Preset Value	0.01
Unit	Depends on measurement parameters

Examples:

Scale the logarithmic axis division scale of channel 1 trace 1 to 10:

:DISP:WIND1:TRAC1:Y:PDIV 10

Query the division scale of channel 2 trace 2:

:DISP:WIND2:TRAC2:Y:PDIV?

Query Response: {< number>}<newline><^END>

Related keys: **Scale** > **Scale/Div**

◆ :DISP:WIND<Ch>:TRAC<Tr>:Y:RLEV

Command Type: Command/Query

Syntax:

:DISPlay:WINDow<Ch>:TRACe<Tr>:Y[:SCALe]:RLEVel < number>

:DISPlay:WINDow<Ch>:TRACe<Tr>:Y[:SCALe]:RLEVel?

Description: Set or query the reference value of the selected trace of the selected channel when the vertical coordinate is linear axis. This command will only be responded to when the vertical coordinate is linear

Parameters:

Parameter	Numerical Value
Description	Reference value
Data Type	Double precision type (double)
Range	-1E15 - 1E15
Preset Value	99
Unit	Depends on measurement parameters

Examples:

Set the vertical coordinate reference value of channel 1 trace 1 to 1M:

:DISP:WIND1:TRAC1:Y:RLEV 1E6

Query the vertical coordinate reference value of channel 2 trace 2:

:DISP:WIND2:TRAC2:Y:RLEV?

Query Response: {< number>}<newline><^END>

Related keys: **Scale** > **Reference Y Value**

◆ :DISP:WIND<Ch>:TRAC<Tr>:Y:RPOS

Command Type: Command/Query

Syntax:

:DISPlay:WINDow<Ch>:TRACe<Tr>:Y[:SCALe]:RPOSition < number>

:DISPlay:WINDow<Ch>:TRACe<Tr>:Y[:SCALe]:RPOSition?

Description: Set or query the relative position of selected trace of the selected channel in the vertical coordinate reference value on the vertical coordinate, the value can be set from 0 to the set number of vertical coordinate partitions. This command will only be responded to if the vertical coordinate is linear

Parameters:

Parameter	Numerical Value
Description	Reference value
Data Type	Integer
Range	0 - 30
Preset Value	5

Examples:

Set the position of the reference value of channel 1 trace 1 as 5:

:DISP:WIND1:TRAC1:Y:RPOS 5

Query the position of the reference value of channel 2 trace 2:

:DISP:WIND2:TRAC2:Y:RPOS?

Query Response: {< number>}<newline><^END>

Related keys: [Scale](#) > [Reference Position](#)

◆ :DISP:WIND<Ch>:TRAC<Tr>:Y:TOP

Command Type: Command/Query

Syntax:

:DISPlay:WINDow<Ch>:TRACe<Tr>:Y[:SCALe]:TOP < number>

:DISPlay:WINDow<Ch>:TRACe<Tr>:Y[:SCALe]:TOP?

Description: Set or query the maximum value of the selected trace of the selected channel when the vertical coordinate is logarithmic axis. This command is only responded to when the vertical coordinate is logarithmic

Parameters:

Parameter	Numerical Value
Description	Logarithmic maximum value
Data Type	Double precision type (double)
Range	1E-18 - 1E15

Preset Value	10k
Unit	Depends on measurement parameters

Examples:

Set the logarithmic upper limit of channel 1 trace 1 to 1M:

:DISP:WIND1:TRAC1:Y:TOP 1E9

Query the logarithmic upper limit of channel 2 trace 2:

:DISP:WIND2:TRAC2:Y:TOP?

Query Response: {< number>}<newline><^END>

Related keys: **Scale** > **Log-Y Top**

◆ :DISP:WIND<Ch>:TRAC<Tr>:Y:SPAC

Command Type: Command/Query

Syntax:

:DISPlay:WINDow<Ch>:TRACe<Tr>:Y:SPACing {LINear|LOGarithmic}

:DISPlay:WINDow<Ch>:TRACe<Tr>:Y:SPACing?

Description: Set and query the Y-axis type (linear/logarithmic axis) of the selected trace of the selected channel

Parameters:

Parameters	Selection Option
Description	Y-axis type
Data Type	Character string type (String)
Range	LINear LOGarithmic
Preset Value	LINear

Examples:

Set the vertical coordinate of channel 1 trace 1 to the logarithmic:

:DISP:WIND1:TRAC<Tr>:Y:SPAC LOG

Query the vertical coordinate type of channel 2 trace 2:

:DISP:WIND2:TRAC2:Y:SPAC?

Query Response: {LIN|LOG}< newline><^END>

Related keys: **Format** > **Y-Axis**

◆ :DISP:WIND<Ch>:X:SPAC

Command Type: Command/Query

Syntax:

:DISPlay:WINDow<Ch>:X:SPACing {LINear|OBASe}

:DISPlay:WINDow<Ch>:X:SPACing?

Description: Set and query the type of the X-axis as frequency mode | sequential mode when the sweep type is Segment (Segment)

Parameters:

Parameter	Selection Option
Description	X-axis type
Data Type	Character string type (String)
Range	LINear: Frequency base OBASe: Order base
Preset Value	OBASe

Examples:

Set the horizontal coordinate of channel 1 to frequency base:

:DISP:WIND1:X:SPAC LIN

Query the horizontal coordinate type of channel 2:

:DISP:WIND2:X:SPAC?

Query Response: {LIN|OBA}< newline><^END>

Related keys: **Sweep Setup** > **Segment Display**

◆ :DISP:WIND<Ch>:Y:DIV

Command Type: Command/Query

Syntax:

:DISPlay:WINDow<Ch>:Y[:SCALe]:Divisions < number>

:DISPlay:WINDow<Ch>:Y[:SCALe]:DIVisions?

Description: Set and query the number of divisions of the Y-axis of the coordinate system. This command will only be responded to if the vertical coordinate is linear

Parameters:

Parameter	Numerical Value
Description	Number of Y-axis divisions
Data Type	Numeric type (Integer)
Range	4 - 30
Preset Value	10

Examples:

Divide the Y-axis of channel 1 into 10 divisions:

:DISP:WIND1:Y:DIV 10

Query the number of Y-axis divisions of channel 2:

:DISP:WIND2:Y:DIV?

Query Response: {< number> }<newline><^END>

Related keys: [Scale](#) > [Divisions](#)

9.2.5.4 INIT

◆ :INIT<Ch>

Command Type: Command

Syntax:

:INITiate<Ch>[:IMMediate]

Description: When the command is input, if the trigger state of the selected channel is in hold mode, the trigger state of the channel will be set to single mode for one sweep cycle; when the sweep cycle is finished, the trigger state returns to hold mode. If the trigger mode of this channel is not in hold mode, then return an error

Related keys: [Trigger Mode](#) > [Single](#)

◆ :INIT<Ch>:CONT

Command Mode: Command/Query

Syntax:

:INITiate<Ch>:CONTinuous {ON|OFF|1|0}

:INITiate<Ch>:CONTinuous?

Description: Set and query whether the trigger mode of the selected channel is continuous mode

Parameters:

Parameter	Selection Option
Description	Continuous mode
Data Type	Boolean type (Boolean)
Range	ON OFF 1 0
Preset Value	ON

Examples:

Set the trigger mode of channel 1 to continuous mode:

```
:INIT1:CONT ON
```

Query whether the trigger mode of channel 2 is continuous mode:

```
:INIT2:CONT?
```

Query Response: {1|0}< newline><^END>

Related keys: [Trigger Mode](#) > [Continuous](#)

9.2.5.5 MMEMORY

◆ :MMEM:_COPY

Command Type: Command

Syntax:

```
:MMEMory:COPY "< filename1>", "< filename2>"
```

Description: Copy the file from file name 1 to file name 2

Example:

```
:MMEM:COPY "D:\temp1.txt", "D:\temp2.txt"
```

◆ :MMEM:DEL

Command Type: Command

Syntax:

```
:MMEMory:DEL "< filename>"
```

Description: Delete the file in the specified location

Example:

```
:MMEM:DEL "D:\temp1.txt"
```

◆ :MMEM:LOAD

Command Type: Command

Syntax:

```
:MMEMory:LOAD[:STATe] "< filename>"
```

Description: Load the sweep state settings file of the specified location

Related keys: [Save/Recall](#) > [Recall State](#) > [Recall State](#)

◆ :MMEM:LOAD:CHAN

Command Type: Command

Syntax:

```
:MMEMory:LOAD:CHANnel[:STATe] {A|B|C|D}
```

Description: Load the sweep channel state settings of the specified gear

Related keys: [Save/Recall](#) > [Recall Channel](#)

◆ :MMEM:LOAD:LIM

Command Type: Command

Syntax:

```
:MMEMory:LOAD:LIMit "< filename>"
```

Description: Load the sweep limit test file of the specified location

Related keys: [Analysis](#) > [Limit Test](#) > [Edit Limit Line](#) > [Import](#)

◆ :MMEM:LOAD:SEGM

Command Type: Command

Syntax:

```
:MMEMory:LOAD:SEGMent "< filename>"
```

Description: Load the sweep segment state settings file of the specified location

Related keys: [Sweep Setup](#) > [Edit Frequency Segment](#) > [Import](#)

◆ :MMEM:STOR

Command Type: Command

Syntax:

:MMEMory:STORe[:STATe] "< filename>"

Description: Save the sweep state settings file in the specified location

Related keys: [Save/Recall](#) > [Save State](#) > [Save State](#)

◆ :MMEM:STOR:CHAN

Command Type: Command

Syntax:

:MMEMory:STORe:CHANnel[:STATe] {A|B|C|D}

Description: Load the sweep channel state settings in the specified gear

Related keys: [Save/Recall](#) > [Save Channel](#)

◆ :MMEM:STOR:CHAN:CLE

Command Type: Command

Syntax:

:MMEMory:STORe:CHANnel:CLEar

Description: Clear all saved channel settings

Related keys: [Save/Recall](#) > [Save Channel](#) > [Clear States](#)

◆ :MMEM:STOR:EPAR

Command Type: Command

Syntax:

:MMEMory:STORe:EPARameters[:STATe] "< filename>"

Description: Save the equivalent circuit simulation result file in the specified location

Related keys: [Analysis](#) > [Equivalent Circuit](#) > [Export](#)

◆ :MMEM:STOR:FDAT

Command Type: Command

Syntax:

:MMEMory:STORe:FDATa "< filename>"

Description: Save the measurement data of the current active channel of the active trace at the specified location

Related keys: **Save/Recall** > **Save Trace Data** > **Scope** > **Single**

◆ :MMEM:STOR:IMAG

Command Type: Command

Syntax:

:MMEMory:STORe:IMAGe "< filename>"

Description: Save the screenshot of the current screen in the specified location (please do not set the file path to the root of the C drive)

Related keys: **System** > **Dump Screen Image**

◆ :MMEM:STOR:LIM

Command Type: Command

Syntax:

:MMEMory:STORe:LIMit "< filename>"

Description: Save the sweep limit test settings file in the specified location

Related keys: **Analysis** > **Limit Test** > **Edit Limit Line** > **Export**

◆ :MMEM:STOR:SALL

Command Type: Command/Query

Syntax:

:MMEMory:STORe:SALL {ON|OFF|1|0}

:MMEMory:STORe:SALL?

Description: Set or query the save mode when the sweep state is saved, it only saves the currently displayed channels and traces, or saves all channels and traces

Parameters:

Parameter	Selection Option
-----------	------------------

Description	Save mode
Data Type	Boolean type (Boolean)
Range	ON OFF 1 0
Preset Value	OFF

Examples:

Set the save mode to save all channels and traces:

:MMEM:STOR:SALL ON

Query the current save mode:

:MMEM:STOR:SALL?

Query Response: {1|0}< newline><^END>

Related keys: [Save/Recall](#) > [Channel/Trace](#)

◆ :MMEM:STOR:SEGM

Command Type: Command

Syntax:

:MMEMory:STORe:SEGMemt "< filename>"

Description: Save the sweep segment state settings file in the specified location

Related keys: [Sweep Setup](#) > [Edit Frequency Segment](#) > [Export](#)

◆ :MMEM:STOR:STYP

Command Type: Command/Query

Syntax:

:MMEMory:STORe:STYPe {STATe|DState}

:MMEMory:STORe:STYPe?

Description: Set or query the save range when the sweep state is saved, only the setup state is saved, or the trace data is also saved

Parameters:

Parameter	Selection Option
Description	Scope
Data Type	Character string type (String)
Range	STATe: Save the setting state only

	DSTate: Save both setup state and trace data
Preset Value	STATe

Examples:

Set the save scope to save the setup state and trace data:

:MMEM:STOR:STYP DST

Query the current save scope:

:MMEM:STOR:STYP?

Query Response: {STAT|DST}< newline><^END>

Related keys: Save/Recall > Save Type

9.2.5.6 SENSE

◆ :SENS:APER

Command Type: Command/Query

Syntax:

:SENSe<Ch>:APERture[:TIME] {1|2|3|4|5}

:SENSe<Ch>:APERture[:TIME]?

Description: Set and query the sweep time of the selected channel

Parameters:

Parameter	Selection Option
Description	Measurement time
Data Type	Numeric type (Integer)
Range	1 2 3 4 5
Preset Value	1

Examples.

Set the measurement time of channel 1 to 2:

:SENS1:APER 2

Query the measurement time of channel 2:

:SENS2:APER?

Query Response: {1|2|3|4|5}< newline><^END>

Related keys: Avg > Meas Time

◆ :SENS<Ch>:AVER

Command Type: Command/Query

Syntax:

:SENSe<Ch>:AVERAge[:STATe] {ON|OFF|1|0}

:SENSe<Ch>:AVERAge[:STATe]?

Description: Set or query the point average of the selected channel

Parameters:

Parameter	Selection Option
Description	Point Average
Data Type	Boolean type (Boolean)
Range	ON OFF 1 0
Preset Value	OFF

Examples:

Turn on the point average of channel 1:

:SENS1:AVER ON

Query the point average state of channel 2:

:SENS2:AVER?

Query Response: {1|0}< newline><^END>

Related keys: [Avg](#) > [Point Avg](#)

◆ :SENS<Ch>:AVER:COUN

Command Type: Command/Query

Syntax:

:SENSe<Ch>:AVERAge:COUNT < number>

:SENSe<Ch>:AVERAge:COUNT?

Description: Set or query the point average count of the selected channel

Parameters:

Parameter	Selection Option
Description	Average factor

Data Type	Numeric type (Integer)
Range	1 - 999
Preset Value	1

Examples:

Set the point average count of channel 1 to 5:

:SENS1:AVER:COUN 5

Query the point average count of channel 2:

:SENS2:AVER:COUN?

Query Response: {< number>}<newline><^END>

Related keys: [Avg](#) > [Point Avg Factor](#)

◆ :SENS<Ch>:DC:MEAS:CLE

Command Type: Command

Syntax:

:SENSe<Ch>:DC:MEASure:CLEar

Description: Clear the DC monitor data of the selected channel

Related keys: [Meas](#) > [DC Monitor Setup](#) > [Clear](#)

◆ :SENS<Ch>:DC:MEAS:DATA:DCI

Command Type: Query

Syntax:

:SENSe<Ch>:DC:MEASure:DATA:DCI?

Description: Query the DC monitor current of the specified channel

Query Response: {< number>}<newline><^END>

◆ :SENS<Ch>:DC:MEAS:DATA:DCV

Command Type: Query

Syntax:

:SENSe<Ch>:DC:MEASure:DATA:DCV?

Description: Query the DC monitoring voltage of the specified channel

Query Response: {< number>}<newline><^END>

◆ :SENS<Ch>:DC:MEAS:ENAB

Command Type: Command/Query

Syntax:

:SENSe<Ch>:DC:MEASure:ENABle {ON|OFF|1|0}

:SENSe<Ch>:DC:MEASure:ENABle?

Description: Set or query the open state of DC monitor of the selected channel

Parameters:

Parameter	Selection Option
Description	DC monitor state
Data Type	Boolean type (Boolean)
Range	ON OFF 1 0
Preset Value	ON

Examples:

Turn on the DC monitor of channel 1:

:SENS1:DC:MEAS:ENAB ON

Query the open state of the DC monitor of channel 2:

:SENS2:DC:MEAS:ENAB?

Query Response: {1|0}< newline><^END>

Related keys: [Meas](#) > [DC Monitor Setup](#)

◆ :SENS<Ch>:FREQ

Command Type: Command/Query

Syntax:

:SENSe<Ch>:FREQuency[:CW] < number>

:SENSe<Ch>:FREQuency[:CW]?

Description: Set or query the CW frequency of the selected channel

Parameters:

Parameter	Numerical Value
-----------	-----------------

Description	CW frequency
Data Type	Double precision type (double)
Range	10 - 130M
Unit	Hz
Preset Value	1M

Examples:

Set the CW frequency of channel 1 to 10 MHz:

:SENS1:FREQ 1E7

Query the CW frequency of channel 2:

:SENS2:FREQ?

Query Response: {< number> }<newline><^END>

Related keys: Sweep Setup > CW Frequency

◆ :SENS<Ch>:FREQ:CENT

Command Type: Command/Query

Syntax:

:SENSe<Ch>:FREQuency:CENTer < number>

:SENSe<Ch>:FREQuency:CENTer?

Description: Set or query the center value of the sweep frequency of the selected channel

Parameters:

Parameter	Numerical Value
Description	Sweep frequency center value
Data Type	Double precision type (double)
Range	10 - 130M
Unit	Hz
Preset Value	50.5k

Examples:

Set the sweep frequency center value of channel 1 to 1MHz:

:SENS1:FREQ:CENT 1E6

Query the sweep frequency center value of channel 2:

:SENS2:FREQ:CENT?

Query Response: {< number> }<newline><^END>

Related keys: Center

◆ :SENS<Ch>:FREQ:DATA

Command Type: Query

Syntax:

:SENSe<Ch>:FREQuency:DATA?

Description: Query the measurement frequency of all measurement points in the specified channel

Query Response: {< number 1>},{< number 2>}...{< number n>}<newline><^END>

◆ :SENS<Ch>:FREQ:SPAN

Command Type: Command/Query

Syntax:

:SENSe<Ch>:FREQuency:SPAN < number>

:SENSe<Ch>:FREQuency:SPAN?

Description: Set or query the span value of the sweep frequency of the selected channel

Parameters:

Parameter	Numerical Value
Description	Sweep frequency span value
Data Type	Double precision type (double)
Range	0 - 129000000
Unit	Hz
Preset Value	99k

Examples:

Set the sweep frequency span value of channel 1 to 100 kHz:

:SENS1:FREQ:SPAN 1E5

Query the sweep frequency span value of channel 2:

:SENS2:FREQ:SPAN?

Query Response: {< number> }<newline><^END>

Related keys: Span

◆ :SENS<Ch>:FREQ:STAR

Command Type: Command/Query

Syntax:

:SENSe<Ch>:FREQuency:STARt < number>

:SENSe<Ch>:FREQuency:STARt?

Description: Set or query the start value of the sweep frequency of the selected channel

Parameters:

Parameter	Numerical Value
Description	Sweep frequency start value
Data Type	Double precision type (double)
Range	10 - 130M
Unit	Hz
Preset Value	1k

Examples:

Set the sweep frequency start value of channel 1 to 1MHz:

:SENS1:FREQ:STAR 1E6

Query the sweep frequency start value of channel 2:

:SENS2:FREQ:STAR?

Query Response: {< number> }<newline><^END>

Related keys: Start

◆ :SENS<Ch>:FREQ:STOP

Command Type: Command/Query

Syntax:

:SENSe<Ch>:FREQuency:STOP < number>

:SENSe<Ch>:FREQuency:STOP?

Description: Set or query the termination value of the sweep frequency of the selected channel

Parameters:

Parameter	Numerical Value
Description	Sweep frequency termination value
Data Type	Double precision type (double)
Range	10 - 130M
Unit	Hz
Preset Value	100k

Examples:

Set the sweep frequency termination value of channel 1 to 10MHz:

:SENS1:FREQ:STOP 1E7

Query the sweep frequency termination value of channel 2:

:SENS2:FREQ:STOP?

Query Response: {< number> }<newline><^END>

Related keys: Stop

◆ :SENS<Ch>:SEGM:DATA

Command Type: Command/Query

:SENSe<Ch>:SEGMENT:DATA < data>

:SENSe<Ch>:SEGMENT:DATA?

Description: Set or query the segment setting data of the specified channel

Parameters:

Parameter	Data
Description	<p>Segment settings</p> <p>The segment setup data is arranged in the following order, N represents the number of segments and n represents the number between 1 and n</p> <p>Data = {< Start bit>,< Frequency mode>,< Source level setting state>,< DC bias setting state>,< Measurement speed setting state>,< Average factor setting state>, < Measurement time setting state>, < Time delay setting state>,< Number of segments>, < Segment 1 frequency>, < Segment 1 frequency2>, < Segment 1 points>, [Segment 1 source level mode], [Segment 1 source level value], [Segment 1 DC bias mode], [Segment 1 DC bias value], [Segment 1 measurement speed], [Segment 1 average count], [Segment 1 measurement time], [Segment 1 delay time], ... , < Segment N frequency 1>, < Segment N frequency 2>, < Segment N points>, [Segment N source level mode],</p>

	<p>[Segment N source level value], [Segment N DC bias mode], [Segment N DC bias value], [Segment N measurement speed], [Segment N average count], [Segment N measurement time], [Segment N delay time] }</p> <p>The individual parameters are described below:</p> <p>< Start bit>: Always 7</p> <p>< Frequency mode>: Frequency setting mode</p> <p>0: Frequency setting mode is start/stop</p> <p>1: Frequency setting mode is center/span</p> <p>< Source level setting state>: Whether each segment is set the source level</p> <p>0: OFF, 1: ON</p> <p>< DC bias setting state>: Whether each segment is set the DC bias</p> <p>0: OFF, 1: ON</p> <p>< Measurement speed setting state>: Whether each segment is set the measurement speed</p> <p>0: OFF, 1: ON</p> <p>< Average count setting state>: Whether each segment is set the average count</p> <p>0: OFF, 1: ON</p> <p>< Measurement time setting state>: Whether each segment is set the measurement time</p> <p>0: OFF, 1: ON</p> <p>< Delay setting state>: Whether each segment is set the delay time</p> <p>0: OFF, 1: ON</p> <p>< Number of segments>: Total number of segments</p> <p>< Segment n frequency 1>: Segment n start frequency / center frequency, depending on < Frequency mode></p> <p>< Segment n frequency 2>: Segment n stop frequency / span frequency, depending on < Frequency mode></p> <p>< Segment n points>: number of points in segment n, at least 1, total number of points in all segments satisfying 2-1601</p> <p>[Segment n source level mode]: Source level mode for segment n: voltage mode = 0, current mode = 1. Not necessary to set when <source level setting state> = 0</p> <p>[Segment n source level value]: The source level value for segment n. Not necessary to set when < Source level setting state> = 0</p> <p>[Segment n DC bias mode]: DC bias mode for segment n: voltage mode = 0, current mode = 1. Not necessary to set when < DC bias setting state > = 0</p> <p>[Segment n DC bias value]: DC bias value of segment n. Not necessary to set when < DC bias setting state > = 0</p> <p>[Segment n measurement speed]: Measurement speed (1-5) of segment n. Not necessary to set when < Measurement speed setting state > = 0</p>
--	---

	<p>[Segment n average count]: Average count of each measurement point for segment n. Not necessary when < Average count setting state >= 0</p> <p>[Segment n measurement time]: The measurement time for segment n does not have to be set when < Measurement time setting state > = 0</p> <p>[Segment n delay time]: Measurement delay time of each point of segment n. Not necessary to set when < delay time setting state >= 0</p> <p>An error will be returned if the necessary parameters are missing or if the value is set incorrectly</p>
Preset Value	7,0,0,0,0,0,0,0,0,0,1,20,1000000,2

Query Response: {< data> }<newline><^END>

Related keys: [Sweep Setup](#) > [Edit Segment Table](#)

◆ :SENS<Ch>:SEGM:SWE:POIN

Command Type: Query

Syntax: :SENSe<Ch>:SEGMENT:SWEep:POINTs?

Description: Query the total number of points in the segment settings of the specified channel

Query Response: {< number>}<newline><^END>

:SENS<Ch>:SWE:DEL

Command Type: Command/Query

Syntax:

:SENSe<Ch>:SWEep:DELay < Digital >

:SENSe<Ch>:SWEep:DELay?

Description: Set or query the sweep delay of the specified channel

Parameters:

Parameter	Numerical Value
Description	Sweep delay
Data Type	Double precision type (double)
Range	0s - 30s
Preset Value	0s

Examples:

Set the sweep delay of channel 1 to 1 second:

:SENS1:SWE:DEL 1

Query the sweep delay of channel 2:

:SENS2:SWE:DEL?

Query Response: {< number>}<newline><^END>

Related keys: Sweep Setup > Sweep Delay

◆ :SENS<Ch>:SWE:DIR

Command Type: Command/Query

Syntax:

:SENSe<Ch>:SWEep:DIRection {UP|DOWN}

:SENSe<Ch>:SWEep:DIRection?

Description: Set and query the sweep direction of the specified channel

Parameters:

Parameter	Selection Option
Description	Sweep direction
Data Type	Character string type (String)
Range	UP: Up DOWN: Down
Preset Value	UP

Examples:

Set the sweep direction of channel 1 to DOWN:

:SENS1:SWE:DIR DOWN

Query the sweep direction of channel 2:

:SENS2:SWE:DIR?

Query Response: {UP|DOWN}< newline><^END>

Related keys: Sweep Setup > Direction

◆ :SENS<Ch>:SWE:PDEL

Command Type: Command/Query

Syntax:

:SENSe<Ch>:SWEep:PDEL < number>

:SENSe<Ch>:SWEep:PDEL?

Description: Set or query the point delay of the specified channel

Parameters:

Parameter	Numerical Value
Description	Point delay
Data Type	Double precision type (double)
Range	0s - 30s
Preset Value	0s

Examples:

Set the point delay of channel 1 to 1 second:

:SENS1:SWE:PDEL 1

Query the point delay of channel 2:

:SENS2:SWE:PDEL?

Query Response: {< number>}<newline><^END>

Related keys: [Sweep Setup](#) > [Point Delay](#)

◆ :SENS<Ch>:SWE:POIN

Command Type: Command/Query

Syntax:

:SENSe<Ch>:SWEep:POINts <number>

:SENSe<Ch>:SWEep:POINts?

Description: Set or query the number of measurement points of the specified channel

Parameters:

Parameter	Numerical Value
Description	Points
Data Type	Numeric type (Integer)
Range	2 - 1601
Preset Value	201

Examples:

Set the points of channel 1 to 100:

:SENS1:SWE:POIN 100

Query the points of channel 2:

:SENS2:SWE:POIN?

Query Response: {< number>}<newline><^END>

Related keys: [Sweep Setup](#) > [Points](#)

◆ :SENS<Ch>:SWE:TIME

Command Type: Command/Query

Syntax:

:SENSe<Ch>:SWEep:TIME < number>

:SENSe<Ch>:SWEep:TIME?

Description: Set or query the sweep time of the specified channel

Parameters:

Parameter	Numerical Value
Description	Measurement time
Data Type	Double precision type (double)
Range	0s - 86400s
Preset Value	0s

Examples:

Set the measurement time of channel 1 to 10 seconds:

:SENS1:SWE:TIME 10

Query the measurement time of channel 2:

:SENS2:SWE:TIME?

Query Response: {< number>}<newline><^END>

Related keys: [Sweep Setup](#) > [Sweep Time](#)

◆ :SENS<Ch>:SWE:TYPE

Command Type: Command/Query

Syntax:

:SENSe<Ch>:SWEep:TYPE {LINear|LOGarithmic|SEGMENT|POWER|BIAS|LBias}

:SENSe<Ch>:SWEep:TYPE?

Description: Set and query the sweep type (stimulus value) of the specified channel

Parameters:

Parameter	Selection Option
Description	Sweep Type
Data Type	Character string type (String)
Range	LINear: Stimulus value is linear frequency LOGarithmic: Stimulus value is logarithmic frequency SEGMENT: Stimulus value is segment POWER: Stimulus value is signal source level BIAS: Stimulus value is linear DC bias LogBias: Stimulus value is logarithmic DC bias
Preset Value	LINear

Examples:

Set the sweep type of channel 1 to the signal source level:

:SENS1:SWE:TYPE POW

Query the sweep type of channel 2:

:SENS2:SWE:TYPE?

Query Response: {LIN|LOG|SEGMENT|POWER|BIAS|LBI}< newline><^END>

Related keys: Sweep Type

9.2.5.7 SERVICE

◆ :SERV:ACH:ACT

Command Type: Command/Query

Syntax:

:SERVice:ACHannel:ACTive <Value>

:SERVice:ACHannel:ACTive?

Description: Set or query the currently active channel

Parameters:

Parameters	Numerical Value
Description	Active channel serial number
Data Type	Numeric type (Integer)
Range	1 - 4
Preset Value	1

Examples:

Set channel 1 as the active channel:

:SERV:ACH:ACT 1

Query the currently active channel:

:SERV:ACH:ACT?

Query Response: {< number>}<newline><^END>

Related keys: Channel Prev | Channel Next

◆ :SERV:ACH:COUN

Command Type: Query

Syntax: :SERVice:ACHannel:COUNt?

Description: Query the number of currently displayed channels

Query Response: {< number>}<newline><^END>

◆ :SERV:CHAN<Ch>:ATR:ACT

Command Type: Command/Query

Syntax:

:SERVice:CHANnel<Ch>:ATRace:ACTive < Digital>

:SERVice:CHANnel<Ch>:ATRace:ACTive?

Description: Set and query the active trace of the selected channel

Parameters:

Parameter	Numerical Value
Description	Active trace serial number
Data Type	Numeric type

	(Integer)
Range	1 - 4
Preset Value	1

Examples:

Set the channel 1 trace 1 as the active trace:

:SERV:CHAN1:ATR:ACT 1

Query the active trace of channel 2:

:SERV:CHAN2:ATR:ACT?

Query Response: {< number>}<newline><^END>

Related keys: Trace Prev | Trace Next

◆ :SERV:CHAN<Ch>:ATR:COUN

Command Type: Query

Syntax:

:SERVice:CHANnel<Ch>:ATRACE:COUNt?

Description: Query the number of traces of the currently selected channel

Query Response: {< number>}<newline><^END>

◆ :SERV:CHAN<Ch>:SEGM:DATA

Command Type: Query

Syntax:

:SERVice:CHANnel<Ch>:SEGMENT:DATA?

Description: Query the number of data to be set for the trace segments of the currently selected channel

Query Response: {< number>}<newline><^END>

◆ :SERV:CHAN<Ch>:SWE:POIN

Command Type: Query

Syntax:

:SERVice:CHANnel<Ch>:SWEep:POINT?

Description: Query the number of measurement points in the current sweep span

◆ :SERV:CHAN<Ch>:TRAC<Tr>:AMRK:ACT

Command Type: Command/Query

Syntax:

:SERVice:CHANnel<Ch>:TRACe<Tr>:AMRKer:ACTive < Digital>

:SERVice:CHANnel<Ch>:TRACe<Tr>:AMRKer:ACTive?

Description: Set and query the active marker of the selected trace of the selected channel

Parameters:

Parameters	Numerical Value
Description	Active marker serial number
Data Type	Numeric type (Integer)
Range	0 - 10 0: Marker not selected 10: Reference marker
Preset Value	0

Examples:

Set the active marker of channel 1 trace 1 to 1:

:SERV:CHAN1:TRAC1:AMRK:ACT 1

Query the active marker of channel 2 trace 2:

:SERV:CHAN2:TRAC2:AMRK:ACT?

Query Response: {< number>}<newline><^END>

Related keys: **Marker** > **Marker 1 - Marker 9**, **Reference Marker**

◆ :SERV:SWE:FREQ:MAX

Command Type: Query

Syntax:

:SERVice:SWEep:FREQuency:MAXimum?

Description: Query the maximum frequency of this machine

◆ :SERV:SWE:FREQ:MIN

Command Type: Query

Syntax:

:SERvice:SWEep:FREQuency:MINimum?

Description: Query the minimum frequency of this machine

◆ :SERV:SWE:POIN

Command Type: Query

Syntax:

:SERvice:SWEep:POINts?

Description: Query the maximum number of measurement points of this machine

9.2.5.8 SOURCE

◆ :SOUR<Ch>:ALC

Command Type: Command/Query

Syntax:

:SOURce<Ch>:ALC[:STATe] {ON|OFF|1|0}

:SOURce<Ch>:ALC[:STATe]?

Description: Set or query the on-off state of automatic level control (ALC) of the specified channel

Parameters:

Parameters	Selection Option
Description	ALC state
Data Type	Boolean type (Boolean)
Range	ON OFF 1 0
Preset Value	ON

Examples:

Turn on the ALC of channel 1: :SOUR1:ALC 1

Query the on-off state of the ALC of channel 2: :SOUR2:ALC?

Query Response: {1|0}< newline><^END>

Related keys: [Sweep Setup](#) > [OSC Level](#) > [ALC](#) > [ALC Control](#)

◆ :SOUR<Ch>:ALC:COUN

Command Type: Command/Query

Syntax:

:SOURce<Ch>:ALC:COUNT < number>

:SOURce<Ch>:ALC:COUNT?

Description: Set or query the maximum number of attempts of automatic level control of the specified channel

Parameters:

Parameter	Numerical Value
Description	Maximum number of ALC attempts
Data Type	Numeric type (Integer)
Range	2 - 10
Preset Value	10

Examples:

Set the maximum number of ALC attempts of channel 1 to 10:

:SOUR1:ALC:COUN 10

Query the maximum number of ALC attempts of channel 2:

:SOUR2:ALC:COUN?

Query Response: {< number>}<newline><^END>

Related keys: [Sweep Setup](#) > [OSC Level](#) > [ALC](#) > [Max Iteration](#)

◆ :SOUR<Ch>:ALC:TOL

Command Type: Command/Query

Syntax:

:SOURce<Ch>:ALC:TOLerance <Value>

:SOURce<Ch>:ALC:TOLerance?

Description: Set or query the target accuracy of automatic level control of the specified channel

Parameters:

Parameters	Numerical Value
Description	ALC target accuracy
Data Type	Double precision type (double)
Range	0.05 - 10
Unit	%
Preset Value	5

Examples:

Set the ALC target accuracy of channel 1 to 1%:

:SOUR1:ALC:TOL 1

Query the ALC target accuracy of channel 2:

:SOUR2:ALC:TOL?

Query Response: <number><newline><^END>

Related keys: [Sweep Setup](#) > [OSC Level](#) > [ALC](#) > [Target %](#)

◆ :SOUR<Ch>:BIAS:CURR:AMPL

Command Type: Command/Query

Syntax:

:SOURce<Ch>:BIAS:CURRent[:LEVel][:IMMediate]:AMPLitude < number>

:SOURce<Ch>:BIAS:CURRent[:LEVel][:IMMediate]:AMPLitude?

Description: Set or query the DC bias current output of the specified channel

Parameters:

Parameter	Numerical Value
Description	DC bias current
Data Type	Double precision type (double)
Range	-0.1 - 0.1
Unit	A
Preset Value	0

Examples:

Set the bias current of channel 1 to 0.1A:

:SOUR1:BIAS:CURR:AMPL 0.1

Query the bias current of channel 2:

:SOUR2:BIAS:CURR:AMPL?

Query Response: {< number>}<newline><^END>

Related keys: **Sweep Setup** > **DC Bias** > **Current Level**

◆ :SOUR<Ch>:BIAS:CURR:CENT

Command Type: Command/Query

Syntax:

:SOURce<Ch>:BIAS:CURRent:CENTer <number>

:SOURce<Ch>:BIAS:CURRent:CENTer?

Description: Set or query the center value of the bias current of the specified channel when the stimulus value is DC bias

Parameters:

Parameter	Numerical Value
Description	Bias current center value
Data Type	Double precision type (double)
Range	-0.1 - 0.1
Unit	A
Preset Value	0

Examples:

Set the bias current center value of channel 1 to 0.1A:

:SOUR1:BIAS:CURR:CENT 0.1

Query the bias current center value of channel 2:

:SOUR2:BIAS:CURR:CENT?

Query Response: {< number>}<newline><^END>

Related keys: **Center** (Sweep mode is DC bias)

◆ :SOUR<Ch>:BIAS:CURR:SPAN

Command Type: Command/Query

Syntax:

:SOURce<Ch>:BIAS:CURRent:SPAN < number>

:SOURce<Ch>:BIAS:CURRent:SPAN?

Description: Set or query the span value of the bias current of the specified channel when the stimulus value is DC bias

Parameters:

Parameter	Numerical Value
Description	Bias current span value
Data Type	Double precision type (double)
Range	0 - 0.2
Unit	A
Preset Value	0

Examples:

Set the bias current span value of channel 1 to 0.1A:

:SOUR1:BIAS:CURR:SPAN 0.1

Query the bias current span value of channel 2:

:SOUR2:BIAS:CURR:SPAN?

Query Response: {< number>}<newline><^END>

Related key: Span (Sweep mode is DC bias)

◆ :SOUR<Ch>:BIAS:CURR:STAR

Command Type: Command/Query

Syntax:

:SOURce<Ch>:BIAS:CURRent:STARt <number>

:SOURce<Ch>:BIAS:CURRent:STARt?

Description: Set or query the start value of the bias current of the specified channel when the stimulus value is DC bias

Parameters:

Parameter	Numerical Value
Description	Bias current start value
Data Type	Double precision type (double)
Range	-0.1 - 0.1

Unit	A
Preset Value	0

Examples:

Set the bias current start value of channel 1 to 0.1A:

:SOUR1:BIAS:CURR:STAR 0.1

Query the bias current start value of channel 2:

:SOUR2:BIAS:CURR:STAR?

Query Response: {< number>}<newline><^END>

Related keys: **Start** (Sweep mode is DC bias)

◆ :SOUR<Ch>:BIAS:CURR:STOP

Command Type: Command/Query

Syntax:

:SOURce<Ch>:BIAS:CURREnt:STOP < number>

:SOURce<Ch>:BIAS:CURREnt:STOP?

Description: Set or query the termination value of the bias current of the specified channel when the stimulus value is DC bias

Parameters:

Parameter	Numerical Value
Description	Bias current termination value
Data Type	Double precision type (double)
Range	-0.1 - 0.1
Unit	A
Preset Value	0

Examples:

Set the bias current termination value of channel 1 to -0.1A:

:SOUR1:BIAS:CURR:STOP -0.1

Query the bias current termination value of channel 2:

:SOUR2:BIAS:CURR:STOP?

Query Response: {< number>}<newline><^END>

Related key: Stop (Sweep mode is DC bias)

◆ :SOUR<Ch>:BIAS:DEL

Command Type: Command/Query

Syntax:

:SOURce<Ch>:BIAS:DELay <Value>

:SOURce<Ch>:BIAS:DELay?

Description: Set or query the bias delay of the specified channel

Parameters:

Parameter	Numerical Value
Description	Bias delay
Data Type	Double precision type (double)
Range	0s - 30s
Preset Value	0s

Examples:

Set the bias delay of channel 1 to 100ms:

:SOUR1:BIAS:DEL 0.1

Query the bias delay of channel 2:

:SOUR2:BIAS:DEL?

Query Response: {< number>}<newline><<^END>

Related keys: Sweep Setup > DC Bias > Bias Delay

◆ :SOUR<Ch>:BIAS:MODE

Command Type: Command/Query

Syntax:

:SOURce<Ch>:BIAS:MODE { VOLTage|CURRent }

:SOURce<Ch>:BIAS:MODE?

Description: Set or query the DC bias mode of the specified channel

Parameters:

Parameter	Selection Option
-----------	------------------

Description	DC bias mode
Data Type	Character string type (String)
Range	VOLT: Voltage mode CURR: Current mode
Preset Value	VOLT

Examples:

Set the DC bias mode of channel 1 to voltage mode:

:SOUR1:BIAS:MODE VOLT

Query the DC bias mode of channel 2:

:SOUR2:BIAS:MODE?

Query Response: {VOLT|CURR}< newline><^END>

Related keys: [Sweep Setup](#) > [DC Bias](#) > [DC Bias Mode](#)

◆ :SOUR<Ch>:BIAS:RANG

Command Type: Command/Query

Syntax:

:SOURce<Ch>:BIAS:RANGe {M1|M10|M100}

:SOURce<Ch>:BIAS:RANGe?

Description: Set or query the DC bias range of the specified channel.

Parameters:

Parameter	Selection Option
Description	DC bias range
Data Type	Character string type (String)
Range	M1: 1mA M10: 10mA M100: 100mA
Preset Value	M1

Examples.

Set the DC bias range of channel 1 to 1mA:

:SOUR1:BIAS:RANG M1

Query the DC bias range of channel 2:

:SOUR2:BIAS:RANG?

Query Response: {M1|M10|M100}< newline><^END>

Related keys: [Sweep Setup](#) > [DC Bias](#) > [Meas Range](#)

◆ :SOUR<Ch> :BIAS:STAT

Command Type: Command/Query

Syntax:

:SOURce<Ch>:BIAS:STATe {ON|OFF|1|0}

:SOURce<Ch>:BIAS:STATe?

Description: Set or query the on-off state of the DC bias of the specified channel

Parameters:

Parameter	Selection Option
Description	DC bias state
Data Type	Boolean type (Boolean)
Range	ON OFF 1 0
Preset Value	OFF

Examples:

Turn on the DC bias of channel 1:

:SOURce1:BIAS:STAT ON

Query the on-off state of the DC bias of channel 2:

:SOURce2:BIAS:STAT?

Query Response: {1|0}< newline><^END>

Related keys: [Sweep Setup](#) > [DC Bias](#) > [DC Bias State](#)

◆ :SOUR<Ch>:BIAS:VOLT:AMPL

Command Type: Command/Query

Syntax:

:SOURce<Ch>:BIAS:VOLTage[:LEVel][:IMMEDIATE]:AMPLitude < number>

:SOURce<Ch>:BIAS:VOLTage [:LEVel][:IMMEDIATE]:AMPLitude?

Description: Set or query the DC bias voltage output of the specified channel

Parameters:

Parameter	Numerical Value
Description	DC bias voltage
Data Type	Double precision type (double)
Range	-40 - 40
Unit	V
Preset Value	0

Examples:

Set the bias voltage of channel 1 to 1V:

:SOUR1:BIAS:VOLT:AMPL 1

Query the bias voltage of channel 2:

:SOUR2:BIAS:VOLT:AMPL?

Query Response: {< number>}<newline><^END>

Related keys: [Sweep Setup](#) > [DC Bias](#) > [Voltage Level](#)

◆ :SOUR<Ch>:BIAS:VOLT:CENT

Command Type: Command/Query

Syntax:

:SOURce<Ch>:BIAS:VOLTage:CENTer <number>

:SOURce<Ch>:BIAS:VOLTage:CENTer?

Description: Set or query the center value of the bias voltage of the specified channel when the stimulus value is DC bias

Parameters:

Parameter	Numerical Value
Description	Bias voltage center value
Data Type	Double precision type (double)
Range	-40 - 40
Unit	V
Preset Value	0

Examples:

Set the bias voltage center value of channel 1 to 1V:

:SOUR1:BIAS:VOLT:CENT 1

Query the bias voltage center value of channel 2:

:SOUR2:BIAS:VOLT:CENT?

Query Response: {< number>}<newline><^END>

Related keys: Center (Sweep mode is DC bias)

◆ :SOUR<Ch>:BIAS:VOLT:SPAN

Command Type: Command/Query

Syntax:

:SOURce<Ch>:BIAS:VOLTage:SPAN <number>

:SOURce<Ch>:BIAS:VOLTage:SPAN?

Description: Set or query the span value of the bias voltage of the specified channel when the stimulus value is DC bias

Parameters:

Parameter	Numerical Value
Description	Bias voltage span value
Data Type	Double precision type (double)
Range	0 - 80
Unit	V
Preset Value	0

Examples:

Set the bias voltage span value of channel 1 to 10V:

:SOUR1:BIAS:VOLT:SPAN 10

Query the bias voltage span value of channel 2:

:SOUR2:BIAS:VOLT:SPAN?

Query Response: {< number>}<newline><^END>

Related key: Span (Sweep mode is DC bias)

◆ :SOUR<Ch>:BIAS:VOLT:STAR

Command Type: Command/Query

Syntax:

:SOURce<Ch>:BIAS:VOLTage:STARt <number>

:SOURce<Ch>:BIAS:VOLTage:STARt?

Description: Set or query the start value of the bias voltage of the specified channel when the stimulus value is DC bias

Parameters:

Parameter	Numerical Value
Description	Bias voltage start value
Data Type	Double precision type (double)
Range	-40 - 40
Unit	V
Preset Value	0

Examples:

Set the bias voltage start value of channel 1 to -1V:

:SOUR1:BIAS:VOLT:STAR -1

Query the bias voltage start value of channel 2:

:SOUR2:BIAS:VOLT:STAR?

Query Response: {< number>}<newline><^END>

Related keys: Start (Sweep mode is DC bias)

◆ :SOUR<Ch>:BIAS:VOLT:STOP

Command Type: Command/Query

Syntax:

:SOURce<Ch>:BIAS:VOLTage:STOP < number>

:SOURce<Ch>:BIAS:VOLTage:STOP?

Description: Set or query the termination value of the bias voltage of the specified channel when the stimulus value is DC bias

Parameters:

Parameter	Numerical Value
Description	Bias voltage termination value

Data Type	Double precision type (double)
Range	-40 - 40
Unit	V
Preset Value	0

Examples:

Set the bias voltage termination value of channel 1 to 1V:

:SOUR1:BIAS:VOLTage:STOP 1

Query the bias voltage termination value of channel 2:

:SOUR2:BIAS:VOLTage:STOP?

Query Response: {< number>}<newline><^END>

Related key: Stop (Sweep mode is DC bias)

◆ :SOUR<Ch>:CURR

Command Type: Command/Query

Syntax:

:SOURce<Ch>:CURRent[:LEVel][:IMMediate][:AMPLitude] < number>

:SOURce<Ch>:CURRent[:LEVel][:IMMediate][:AMPLitude]?

Description: Set or query the signal source current output of the specified channel

Parameters:

Parameter	Numerical Value
Description	Signal source current
Data Type	Double precision type (double)
Range	0.0002 - 0.02
Unit	A
Preset Value	0.02

Examples:

Set the signal source current of channel 1 to 10mA:

:SOUR1:CURR 0.01

Query the signal source current of channel 2:

:SOUR2:CURR?

Query Response: {< number>}<newline><^END>

Related keys: **Sweep Setup** > **OSC Level** > **Current Level**

◆ :SOUR<Ch>:CURR:CENT

Command Type: Command/Query

Syntax:

:SOURce<Ch>:CURRent:CENTer <number>

:SOURce<Ch>:CURRent:CENTer?

Description: Set or query the center value of the signal source current of the specified channel when the stimulus value is signal source level

Parameters:

Parameters	numerical value
Description	Signal source current center value
Data Type	Double precision type (double)
Range	0.0002 - 0.02
Unit	A
Preset Value	0.0101

Examples:

Set the center value of the signal source current of channel 1 to 1mA:

:SOUR1:CURR:CENT 1E-3

Query the center value of the signal source current of channel 2:

:SOUR2:CURR:CENT?

Query Response: {< number>}<newline><^END>

Related keys: **Center** (Sweep mode is signal source level)

◆ :SOUR<Ch>:CURR:SPAN

Command Type: Command/Query

Syntax:

:SOURce<Ch>:CURRent:SPAN < number>

:SOURce<Ch>:CURRent:SPAN?

Description: Set or query the span value of the signal source current of the specified channel when the stimulus value is signal source level

Parameters:

Parameter	Numerical Value
Description	Signal source current span value
Data Type	Double precision type (double)
Range	0 - 0.0198
Unit	A
Preset Value	0.0198

Examples:

Set the span value of the signal source current of channel 1 to 10mA:

:SOUR1:CURR:SPAN 0.01

Query the span value of the signal source current of channel 2:

:SOUR2:CURR:SPAN?

Query Response: {< number>}<newline><^END>

Related keys: Span (Sweep mode is signal source level)

◆ :SOUR<Ch>:CURR:STAR

Command Type: Command/Query

Syntax:

:SOURce<Ch>:CURRent:STARt < number>

:SOURce<Ch>:CURRent:STARt?

Description: Set or query the start value of the signal source current of the specified channel when the stimulus value is signal source level

Parameters:

Parameter	Numerical Value
Description	Signal source current start value
Data Type	Double precision type (double)
Range	0.0002 - 0.02
Unit	A

Preset Value	0.0002
--------------	--------

Examples:

Set the start value of signal source current of channel 1 to 1mA:

:SOUR1:CURR:STAR 1E-3

Query the start value of signal source current of channel 2:

:SOUR2:CURR:STAR?

Query Response: {< number>}<newline><^END>

Related keys: **Start** (Sweep mode is signal source level)

◆ :SOUR<Ch>:CURR:STOP

Command Type: Command/Query

Syntax:

:SOURce<Ch>:CURRent:STOP < number>

:SOURce<Ch>:CURRent:STOP?

Description: Set or query the termination value of the signal source current of the specified channel when the stimulus value is signal source level

Parameters:

Parameter	Numerical Value
Description	Signal source current termination value
Data Type	Double precision type (double)
Range	0.0002 - 0.02
Unit	A
Preset Value	0.02

Examples:

Set the termination value of the signal source current of channel 1 to 10mA:

:SOUR1:CURR:STOP 0.01

Query the termination value of the signal source current of channel 2:

:SOUR2:CURR:STOP?

Query Response: {< number>}<newline><^END>

Related keys: **Stop** (Sweep mode is DC bias)

◆ :SOUR<Ch>:MODE

Command Type: Command/Query

Syntax:

:SOURce<Ch>:MODE {VOLTage|CURRent}

:SOURce<Ch>:MODE?

Description: Set or query the signal source mode of the specified channel

Parameters:

Parameter	Selection Option
Description	Signal source mode
Data Type	Character string type (String)
Range	VOLT: Voltage mode CURR: Current mode
Preset Value	VOLT

Examples:

Set the signal source mode of channel 1 to voltage mode:

:SOUR1:MODE VOLT

Query the signal source mode of channel 2:

:SOUR2:MODE?

Query Response: {VOLT|CURR}< newline><^END>

Related keys: [Sweep Setup](#) > [OSC Level](#) > [OSC Unit](#)

◆ :SOUR<Ch>:VOLT

Command Type: Command/Query

Syntax:

:SOURce<Ch>:VOLTage[:LEVel][:IMMEDIATE][:AMPLitude] < number>

:SOURce<Ch>:VOLTage[:LEVel][:IMMEDIATE][:AMPLitude]?

Description: Set or query the signal source voltage output of the specified channel

Parameters:

Parameter	Numerical Value
-----------	-----------------

Description	Signal source voltage
Data Type	Double precision type (double)
Range	0.005 - 1
Unit	V
Preset Value	0.5

Examples:

Set the signal source voltage of channel 1 to 100mV:

:SOUR1:VOLT 0.1

Query the signal source voltage of channel 2:

:SOUR2:VOLT?

Query Response: {< number>}<newline><<^END>

Related keys: [Sweep Setup](#) > [OSC Level](#) > [Voltage Level](#)

◆ :SOUR<Ch>:VOLT:CENT

Command Type: Command/Query

Syntax:

:SOURce<Ch>:VOLTage:CENTer <number>

:SOURce<Ch>:VOLTage:CENTer?

Description: Set or query the center value of the signal source voltage of the specified channel when the stimulus value is signal source level

Parameters:

Parameter	Numerical Value
Description	Signal source voltage center value
Data Type	Double precision type (double)
Range	0.005 - 1
Unit	V
Preset Value	0.5025

Examples:

Set the center value of the signal source voltage of channel 1 to 100mV:

:SOUR1:VOLT:CENT 0.1

Query the center value of the signal source voltage of channel 2:

:SOUR2:CURR:CENT?

Query Response: {< number>}<newline><^END>

Related keys: Center (Sweep mode is signal source level)

◆ :SOUR<Ch>:VOLT:SPAN

Command Type: Command/Query

Syntax:

:SOURce<Ch>:VOLTage:SPAN < number>

:SOURce<Ch>:VOLTage:SPAN?

Description: Set or query the span value of the signal source voltage of the specified channel when the stimulus value is signal source level

Parameters:

Parameter	Numerical Value
Description	Signal source voltage span value
Data Type	Double precision type (double)
Range	0 - 0.995
Unit	V
Preset Value	0.995

Examples:

Set the span value of the signal source voltage of channel 1 to 500mV:

:SOUR1:VOLT:SPAN 0.5

Query the span value of the signal source voltage of channel 2:

:SOUR2:VOLT:SPAN?

Query Response: {< number>}<newline><^END>

Related keys: Span (Sweep mode is signal source level)

◆ :SOUR<Ch>:VOLT:STAR

Command Type: Command/Query

Syntax:

:SOURce<Ch>:VOLTage:STARt < number>

:SOURce<Ch>:VOLTage:STARt?

Description: Set or query the start value of the signal source voltage of the specified channel when the stimulus value is signal source level

Parameters:

Parameter	Numerical Value
Description	Signal source current start value
Data Type	Double precision type (double)
Range	0.005 - 1
Unit	V
Preset Value	0.005

Examples:

Set the start value of the signal source voltage of channel 1 to 10mV:

:SOUR1:VOLT:STAR 0.01

Query the start value of the signal source voltage of channel 2:

:SOUR2:VOLT:STAR?

Query Response: {< number>}<newline><^END>

Related keys: **Start** (Sweep mode is signal source level)

◆ :SOUR<Ch>:VOLT:STOP

Command Type: Command/Query

Syntax:

:SOURce<Ch>:VOLTage:STOP < number>

:SOURce<Ch>:VOLTage:STOP?

Description: Set or query the termination value of the signal source voltage of the specified channel when the stimulus value is signal source level

Parameters:

Parameter	Numerical Value
Description	Signal source voltage termination value
Data Type	Double precision type (double)
Range	0.005 - 1

Unit	V
Preset Value	1

Examples:

Set the termination value of the signal source voltage of channel 1 to 100mV:

:SOUR1:VOLT:STOP 0.1

Query the termination value of the signal source voltage of channel 2:

:SOUR2:VOLT:STOP?

Query Response: {< number>}<newline><^END>

Related keys: Stop (Sweep mode is DC bias)

9.2.5.9 TRIGGER

◆ :TRIG

Command Type: Command

Syntax:

:TRIGger

Description: When the trigger source is manual trigger and the trigger mode is not hold mode, a trigger is performed

◆ :TRIG:AVER

Command Type: Command/Query

Syntax:

:TRIGger[:SEQuence]:AVERage {ON|OFF|1|0}

:TRIGger[:SEQuence]:AVERage?

Description: Set or query the open state of the average trigger of the current channel

Parameters:

Parameter	Selection Option
Description	Average trigger state
Data Type	Boolean (Boolean)
Range	ON OFF 1 0
Preset Value	OFF

Examples:

Turn on the average trigger:

TRIG:AVER ON

Query the open state of the average trigger:

TRIG:AVER?

Query Response: {1|0}< newline><^END>

Related keys: [Avg](#) > Avg Trigger

◆ :TRIG:POIN

Command Type: Command/Query

Syntax:

:TRIGger[:SEQuence]:POINt {ON|OFF|1|0}

:TRIGger[:SEQuence]:POINt?

Description: Set whether the point-by-point mode of the trigger is turned on

Parameters:

Parameter	Selection Option
Description	Point-by-point trigger state
Data Type	Boolean type (Boolean)
Range	ON OFF 1 0
Preset Value	OFF

Examples:

Turn on the point-by-point trigger:

:TRIG:POIN ON

Query the on-off state of the point-by-point trigger:

:TRIG:POIN?

Query Response: {1|0}< newline><^END>

Related keys: [Trigger Mode](#) > Trigger Event

◆ :TRIG:EXT:DEL

Command Type: Command/Query

Syntax:

:TRIGger[:SEQuence]:EXTernal:DELay < number>

:TRIGger[:SEQuence]:EXTernal:DELay?

Description: Set or query the trigger delay of the external trigger

Parameters:

Parameter	Numerical Value
Description	Trigger delay
Data Type	Double precision type (double)
Range	0 - 10
Unit	s
Preset Value	0

Examples:

Set the trigger delay to 1ms:

:TRIG:EXT:DEL 1E-3

Query the trigger delay:

:TRIG:EXT:DEL?

Query Response: {< number>}<newline><^END>

Related keys: [Trigger Mode](#) > [Trigger Delay](#)

◆ :TRIG:SOUR

Command Type: Command/Query

Syntax:

:TRIGger[:SEQuence]:SOURce {INTernal|EXTernal|MANual|BUS}

:TRIGger[:SEQuence]:SOURce?

Description: Set or query the trigger source of the sweep mode

Parameters:

Parameter	Selection Option
Description	Trigger source
Data Type	Character string type (String)
Range	INTernal: Internal trigger

	MANual: Manual trigger EXTernal: External trigger BUS: Bus trigger
Preset Value	INTernal

Examples:

Set the trigger source to manual mode:

:TRIG:SOUR INT

Query the trigger source:

:TRIG:SOUR?

Query Response: {INT|MAN|EXT|BUS}< newline><^END>

Related keys: [Trigger Mode](#) > [Trigger Source](#)

◆ :TRIG:SCOP

Command Type: Command/Query

Syntax:

:TRIGger[:SEQuence]:SCOPE {ALL|ACTive}

:TRIGger[:SEQuence]:SCOPE?

Description: Set or query the trigger scope for all channels in turn or only the active channels

Parameters:

Parameters	Selection Option
Description	Trigger scope
Data Type	Character string type (String)
Range	ALL: Trigger all channels ACTive: Trigger the active channel only
Preset Value	ALL

Examples:

Set the trigger scope to all channels:

:TRIG:SCOP ALL

Query the trigger scope:

:TRIG:SCOP?

Query Response: {ALL|ACTive}< newline><^END>

Related keys: Trigger Mode > Trigger Scope

◆ :TRIG:SING

Command Type: Command

Syntax::TRIGger[:SEQuence]:SINGle

Description: When the trigger source is bus trigger and the trigger mode is not hold mode, immediately perform a trigger

Chapter 10 Handler Instructions for Use

STB8851 provides users with Handler interface, which is mainly used for the output of instrument sorting results. When the instrument is used in the automatic component sorting test system, this interface provides the communication signal with the system and the sorting result output signal. The sorting result output varies depending on the measurement mode. The Handler interface design is flexible. After using different operating procedures, all output signal states are defined according to the usage requirements.

10.1 Definition description

The information provided in this chapter includes the necessary description of the signal lines and electrical characteristics for using the Handler interface.

10.1.1 Signal line definition

The Handler interface uses three signals: sorting output, control input, and control output. The signal lines of the sorting function in different measurement modes are respectively defined as different sorting output signals and control input signals. The following are the signal definitions of the Handler interface when the sorting function is used.

pin number	signal name	describe
1 2 3 4 5 6 7 8 9 10	/BIN1 /BIN2 /BIN3 /BIN4 /BIN5 /BIN6 /BIN7 /BIN8 /BIN9 /OUT	Sorting result output
11	/AUX_	List scan sorting result output
12 13	/EXT.TRIG_	External trigger: When the trigger mode is set to EXT.TRIG (external trigger), the instrument is triggered by the rising edge pulse signal applied to this pin.
14 15	EXT.DCV2	External DC Voltage 2: The DC power supply pin for the photoelectrically coupled signals (/EXT_TRIG, /ALARM, /INDEX, /EOM, /KEY LOCK) in the instrument.
16	+5V	Instrument internal power supply +5V:

17 18		Generally, users are not recommended to use the power supply inside the instrument. If it must be used, please ensure that the current used is less than 0.3A, and the signal line should be kept away from the interference source.
19 20 21 22 twenty three	/PHI /PLO /SREJ /SHI /SIN	List scan sorting result output
24	/SLO	The sorting measurement result is invalid (Invalid) output
25	/KEYLOCK	Spare input pin.
26	NC	no connection
27 28	EXT.DCV1	External DC Voltage 1: Pull-up DC power supply pin for photoelectrically coupled signals (/BIN-/BIN9, /AUX, /OUT, /PHI, /PLO, /SREJ) in the instrument.
29	/ALARM	When a power-down occurs, /ALARM is active.
30	/INDEX	The /INDEX signal is valid when the analog measurement is completed and the instrument can connect the next device under test (DUT) at the UNKNOWN test terminal. However, the comparison result signal is not active until /EOM is active.
31	/EOM	End Of Measurement : This signal is valid when the measurement data and comparison result are valid.
32 33	C OM2	Ground reference used by external power supply EXTV2
34 35 36	C OM1	reference used by external power supply EXTV 1

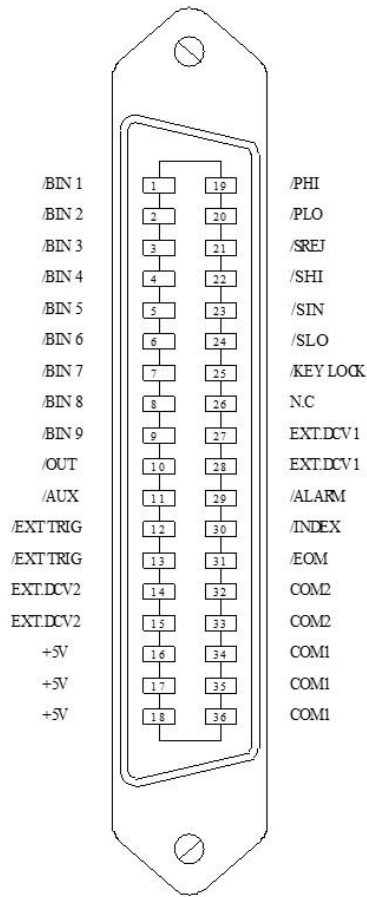

10.1.1.1 Signal Definition for Single Point Measurement

Sorting signal output: / BIN1-/BIN9, / OUT, / SLO (abnormal measurement result);

Control output signal: /INDEX (analog measurement completion signal), /EOM (measurement end and comparison data valid signal), /ALARM (instrument power-down signal).

Control input signals: /EXT.TRIG (external trigger signal) and / Keylock (keylock).

The timing diagram is shown below:

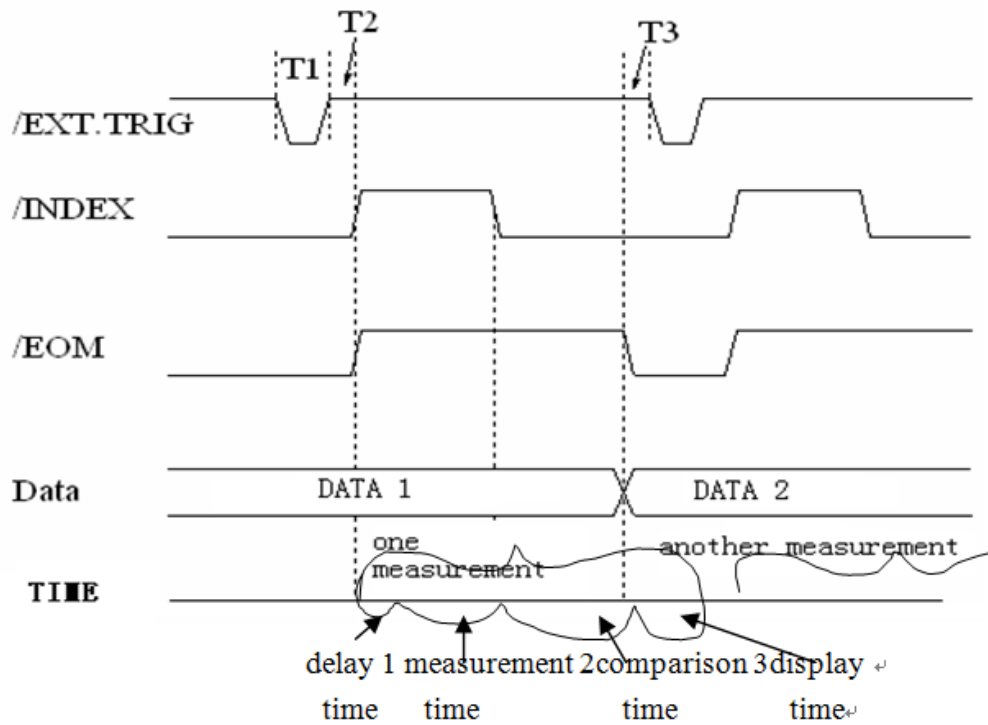

time	minimum value	maximum value
T1 trigger pulse width	1 us	---
T2 measurement start delay time	200 us	Display time + 200us
Trigger wait time after T3 /EOM output	0 us	---

1. Refer to the operation manual of this instrument for measurement time;
2. The typical comparison time is about 1 ms;
3. The typical display time of each display page is as follows:
Component measurement display page: about 8 ms;
Sorting display page: about 5 ms;
Sorting count display page: about 0.5 ms

10.1.1.2 Signal Definition for List Scan

The function signal definition of list scan is different from the definition in point test function. Its definition is as follows:

Sorting signal output:

/ BIN1-/BIN9 , /AUX(BIN10), / OUT , /PHI(BIN11) , /PLO(BIN12), / SREJ (BIN13), / SHI (BIN14), / SIN (BIN15) , / SLO (measurement result abnormal/out of tolerance), the sorting result

will be output after the entire list scan measurement is completed;

Control output signal:

/INDEX (analog measurement completion signal), /EOM (measurement end and comparison data valid signal), /ALARM (instrument power-down signal). Among them, the /INDEX signal is asserted when the analog measurement of the last sweep point is completed. The /EOM signal is asserted when all sorting results are valid after the entire list scan measurement is complete.

Control input signal:

/EXT .TRIG (external trigger signal) and / Keylock (keylock).

The timing diagram is shown in the following figure:

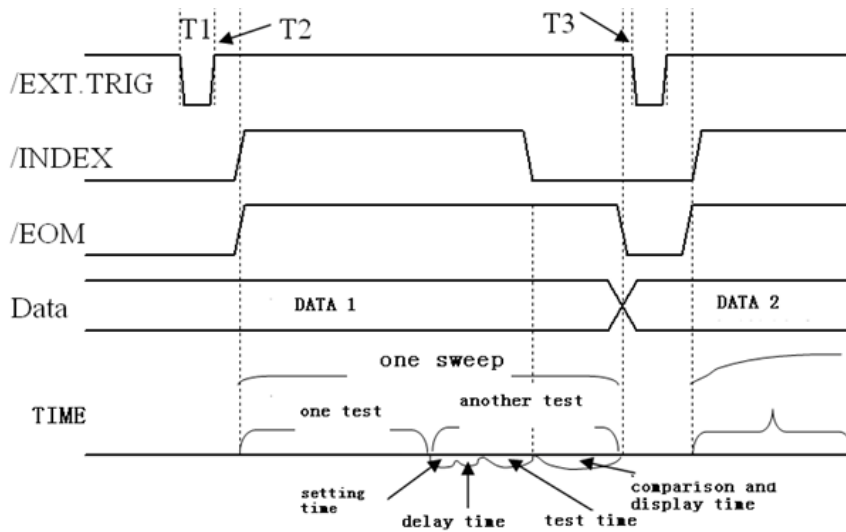

T1, T2, T3, please refer to the definition of spot measurement.

10.1.1.3 Signal Definition for Curve Sweep

The signal definition of curve sweep function is different from that of point measurement and list function. Its definition is as follows:

Sorting signal output:

/BIN1-/BIN4 are the output of the current scan channel's curve 1-curve 4 sorting pass, /BIN5-/BIN8 are the current scan channel's curve 1-curve 4 sorting fail output.

Control output signal:

/INDEX (analog measurement completion signal), /EOM (measurement end and comparison data valid signal), /ALARM (instrument power-down signal). Among them, the /INDEX signal is asserted when the analog measurement of the last sweep point is completed. The /EOM signal is asserted when all sorting results are valid after the entire list scan measurement is complete.

Control input signal:

/EXT .TRIG (external trigger signal) and / Keylock (keylock).

The timing diagram is shown in the following figure:

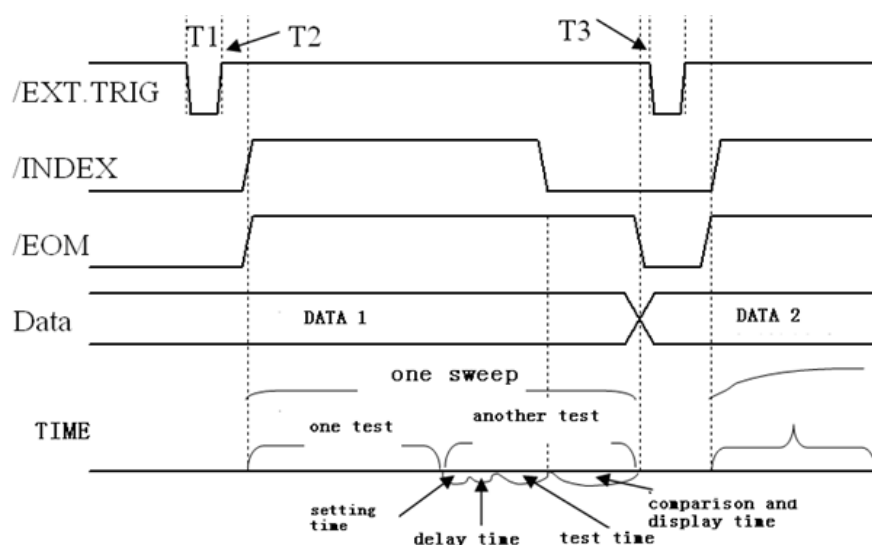

T1, T2, T3, please refer to the definition of spot measurement.

10.1.2 Electrical Characteristic

As mentioned earlier, the definition of a signal differs in different measurement modes, but the electrical characteristics of the signal are consistent. The following description therefore applies to all measurement modes.

DC Isolated Outputs Each DC output (pins 1 to 16) is isolated via an open collector optocoupler output. The output voltage of each line is set by a pull-up resistor on the Handler interface board. Pull-up resistor and internally supplied voltage (+5 V) connection, or connect with external supply voltage (EXTV: +5V) via jumper.

The electrical characteristics of the DC isolated output are divided into two types, as shown in the table below:

output signal	Output rated voltage		Maximum current	circuit reference ground
	LOW	HIGH		
sorting signal /BIN1 - /BIN9 /AUX /OUT /PHI /PLO	≤0.5 V	+5 V--+24 V	6 mA	Internal pull-up voltage: measuring instrument External voltage (EXTV1): COM1
control signal /INDEX /EOM /ALARM	≤0.5 V	+5 V--+24 V	5 mA	Internal pull-up voltage: measuring instrument External Voltage (EXTV2): COM2

10.2 Handler interface board circuit

Sorting result signal output circuit:

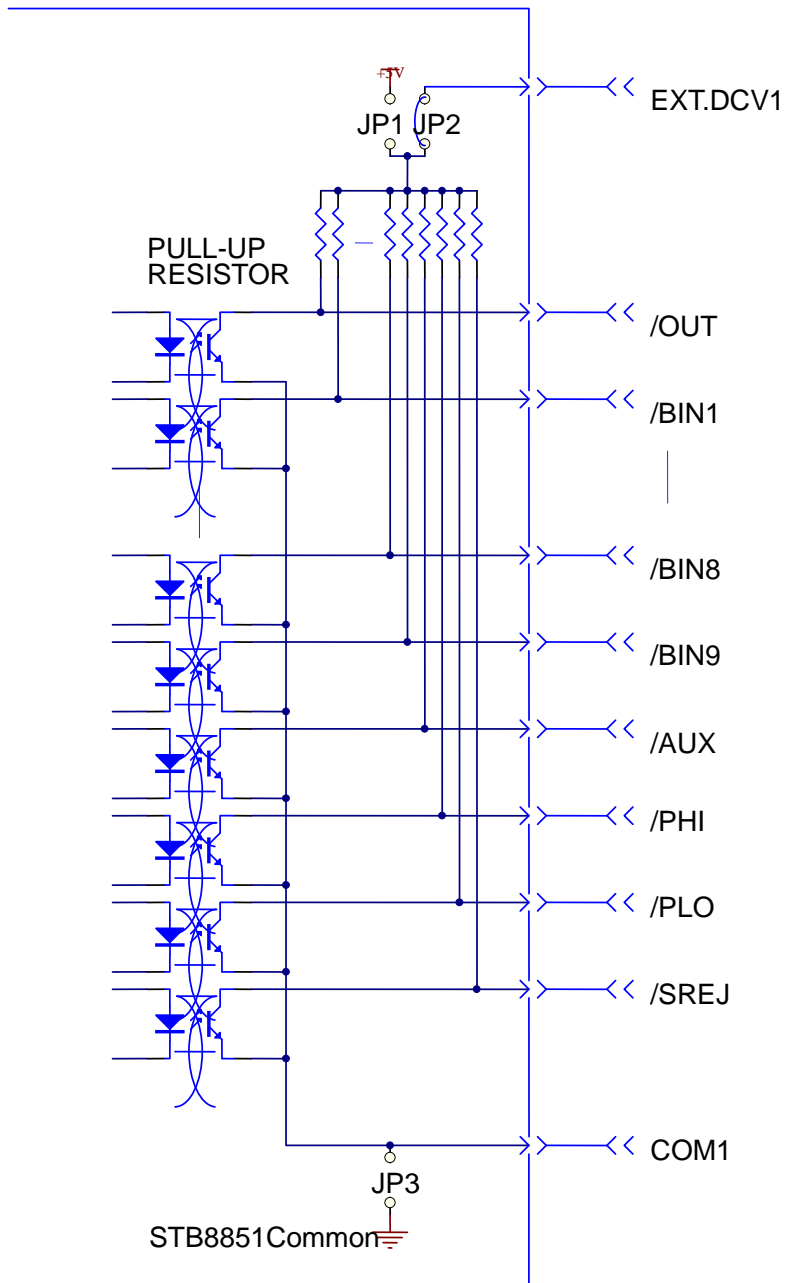

Control signal output circuit:

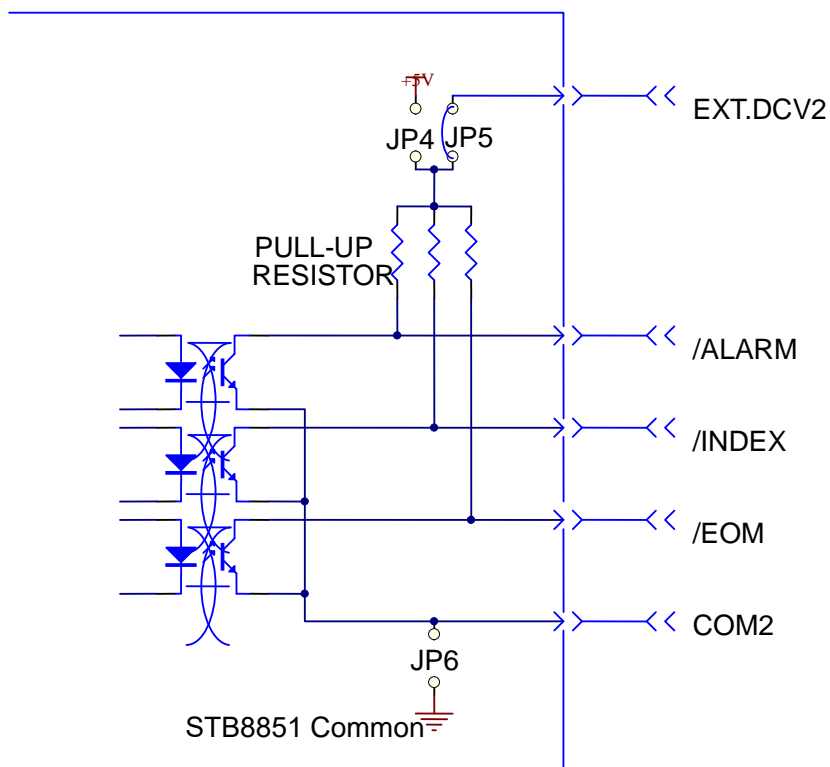

Control signal input circuit:

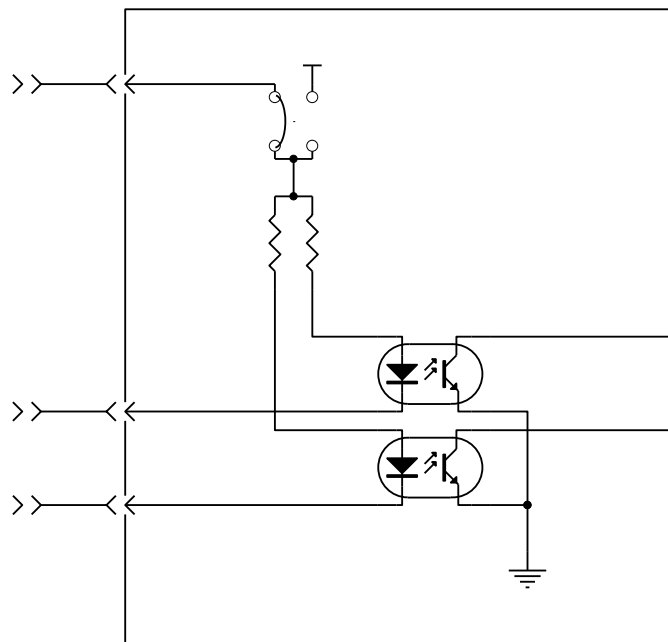

Chapter 11 Technical indicators

11.1 Definition

Technical indicators:

Guaranteed performance. All specifications are at 23 °C (± 5 °C) unless otherwise noted and it is valid within the temperature range and the instrument has been warmed up for 90 minutes. Specifications include guard bands, which take into account expected statistical performance distributions, measurement uncertainty, and performance variations due to environmental conditions.

Typical value:

Expected performance of typical devices, excluding guard bands. Typical values are not covered by the product warranty.

General Features:

A generic descriptive term that does not indicate a level of performance.

11.2 Basic Measurement Feature

Measurement parameters:

Impedance parameter	$ Z $, θ_z , $ Y $, θ_y , C_p , C_s , L_p , L_s , R_p , R_s , D , Q , R , X , G , B , DCR
Level monitoring	Vac , Iac , Vdc , Idc

Measurement terminal:

Configure	Four-terminal pair configuration
Connector type	Four BNC (female) connectors

11.3 Signal source characteristics

Frequency:

scope	10 Hz to 130 MHz (Model STB8851-130) 10 Hz to 80 MHz (Model STB8851-80) 10 Hz to 50 MHz (Model STB8851-50) 10 Hz to 30 MHz (Model STB8851-30) 10 Hz to 15 MHz (Model STB8851-15)
Resolution	1 mHz

Relative error	$\pm 0.0007\%$ (at 5 to 40 °C temperature range, typical)
----------------	---

Voltage signal level:

scope	5 mVrms to 1 Vrms (output resistance 25Ω) 5 mVrms to 2 Vrms (output internal resistance 100Ω and test frequency $\leq 1\text{MHz}$)
Resolution	1 mV
precision	At the test port of STB8851 $\pm [(10 + 0.05 \times f)\% + 1 \text{ mV}]$ (typ., output resistance 25Ω) $\pm [(10 + 0.5 \times f)\% + 1 \text{ mV}]$ (typ., output resistance 100 Ω)

Note:

1. f: frequency [MHz]. The above characteristics apply when all ports are open.
2. When the DUT impedance is $\leq 50 \Omega$, the test signal level should be $\leq 0.5 \text{ Vrms}$
3. When the temperature exceeds $23 \pm 5 \text{ }^\circ\text{C}$, the test signal level setting accuracy is one-half of the described value.

Current signal level:

scope	50 μArms to 20 mArms
Resolution	10 μA
precision	$\pm [(10 + 0.3 \times f)\% + 50 \mu\text{A}]$ (typ., output resistance 25Ω) $\pm [(10 + 0.5 \times f)\% + 50 \mu\text{A}]$ (typ., output resistance 100 Ω)

Note:

1. f: frequency [MHz]. The above characteristics apply when all ports are open.
2. When the impedance of the DUT is less than or equal to 50Ω , the test signal level should be less than or equal to 0.5 Vrms .
3. When the temperature exceeds $23 \pm 5 \text{ }^\circ\text{C}$, the test signal current setting accuracy is one-half of the described value.

Signal level detection:

voltage range	5 mVrms to 2 Vrms
Level detection accuracy	$\pm (10 + 0.05 \times f + 100/ Z_x)[\%]$ (typ.)
Current range	200 μArms to 20 mArms
Current detection accuracy	$\pm (10 + 0.05 \times f + 100/ Z_x)[\%]$ (typ.)

Note:

1. f: Frequency [MHz], Z_x : Impedance test value [Ω]
2. When the temperature exceeds 23 ± 5 °C, the test signal current setting accuracy is one-half of the described value.

Output Impedance:

output impedance	25 Ω /100 Ω (typ.)
------------------	----------------------------------

DC bias function:

DC Voltage Bias Range	
scope	0 to ± 40 V (see Figure 1)
Resolution	1 mV
precision	$\pm [0.1\% + (5 + 30 \times I_{mon}) \text{ mV}]$ $\pm [0.2\% + (10 + 30 \times I_{mon}) \text{ mV}]$ (temperature over 23 ± 5 °C)
DC current bias	
DC Current Bias Range	0 to ± 100 mA (see Figure 1)
DC Current Bias Resolution	40 μA
DC Current Bias Accuracy	$\pm [2\% + (0.2 + V_{mon} /20) \text{ mA}]$ $\pm [4\% + (0.4 + V_{mon} /20) \text{ mA}]$ (temperature over 23 ± 5 °C)
DC voltage bias Detection accuracy	$\pm [0.2\% + (5 + 0.3 \times I_{mon}) \text{ mV}]$ $\pm [0.4\% + (10 + 0.3 \times I_{mon}) \text{ mV}]$ (temperature over 23 ± 5 °C)
DC current bias Detection accuracy	$\pm [1\% + (0.5 + V_{mon} /10000) \text{ mA}]$ $\pm [2\% + (1.0 + V_{mon} /5000) \text{ mA}]$ (temperature over 23 ± 5 °C)
output impedance	25 Ω /100 Ω (nominal)

Note:

V_{mon} : DC voltage offset monitor reading value [mV]

I_{mon} : DC current offset monitor reading value [mA]

DC Bias Voltage/Current Range:

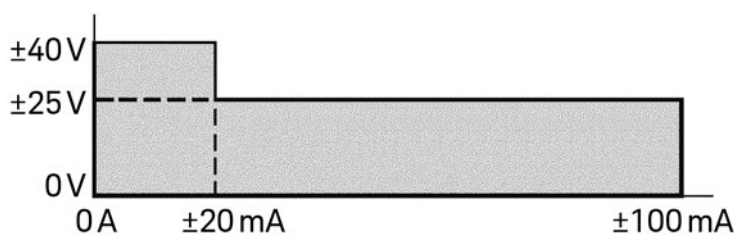

11.4 Scan feature

Scannable parameters	Frequency, Signal Voltage, Signal Current, DC Bias Voltage, DC Bias Current
scan type	Linear frequency, logarithmic frequency, OSC level (voltage, current), DC offset (voltage, current), logarithmic DC bias (voltage, current)
Scan direction	Up-value scan, down-value scan
Measurement points	2 to 1601 points
segmented scan	
Used to measure waveform points per segment, Available setup parameters for the signal	Sweep frequency range, level level (voltage, current), DC offset (voltage, current), measurement time, point average coefficient, Segment time, segment delay
number of segments	1 to 201
Sweep Type	Sequential scan or frequency scan
delay time	
type	Spot delay, sweep delay, segment delay or DC offset delay
scope	0 to 30 seconds
Resolution	1 ms

11.5 Trigger function

trigger type	Continuous trigger, single trigger, average trigger
trigger source	Internal (Auto Trigger, External (Handler Connector Input), GPIB/USB/LAN , Manual (Front Panel Keys)
trigger event type	Point trigger, sweep trigger

11.6 Measurement time/average

Measurement time range	0 (fast) to 5 (precise) , 6 steps
average type	point average, sweep moving average
Average coefficient	1 to 999 (integer value)

Measure time:

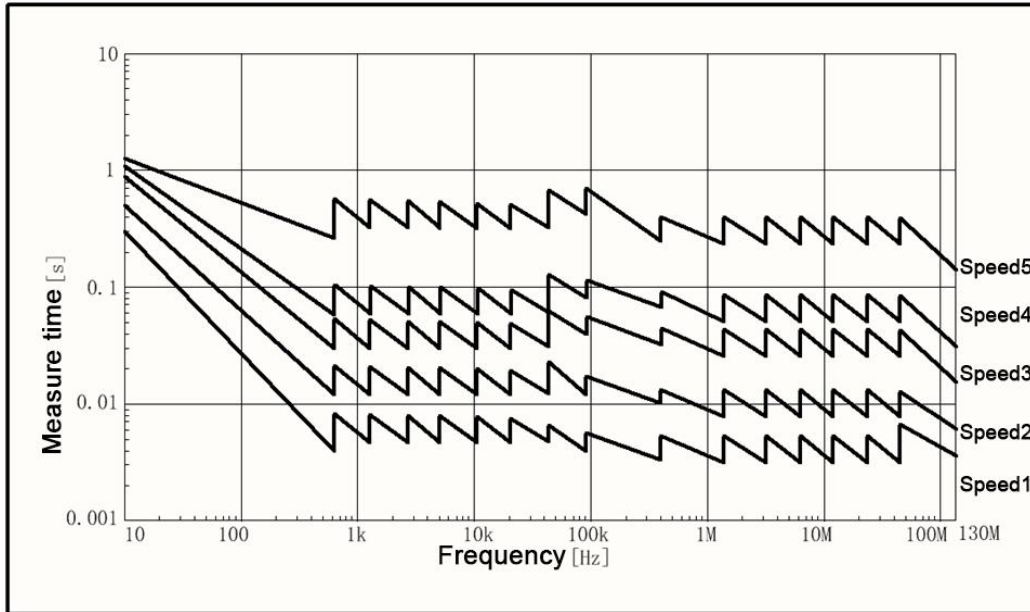

Note:

1. Additional time is required for each test when switching test ranges or when paranoid voltage/current is turned on: $7 \times \text{test frequency period} + 5 \text{ ms}$
2. When automatic level control is turned on, additional test time needs to be added, and the added time varies according to the set conditions.

Test speed 0 can shorten the test time of test speed 1 by about 2ms, and the fastest test time is less than 2.5ms each time. The specific shortened test time varies according to the frequency and range settings.

11.7 Measurement accuracy

Z , Y precision	$\pm E$ [%]
theta accuracy	$\pm E/100$ [rad]
L , C , X , B precision	
When $D_x \leq 0.1$	$\pm E$ [%]
When $D_x > 0.1$	$\pm E \times \sqrt{1 + D_x^2}$ [%]
R precision	
When $D_x \leq 0.1$ ($Q_x \geq 10$)	$R_p : \pm \frac{E}{D_x \text{ mE} / 100} [\%]$ $R_s : \pm E / D_x [\%]$

When $0.1 < D_x < 10$ ($0.1 < Q_x < 10$)	$R_p : \pm E \times \frac{\sqrt{1+D_x^2}}{D_x m \frac{E}{100} \times \sqrt{1+D_x^2}} [\%]$ $R_s : \pm E \times \frac{\sqrt{1+D_x^2}}{D_x} [\%]$
When $D_x \geq 10$ ($Q_x \leq 0.1$)	$\pm E$ [%]
D precision	
When $D_x \leq 0.1$	$\pm E/100$
When $0.1 < D_x \leq 1$	$\pm E \times (1 + D_x) / 100$
Q precision (when $Q_x \times D_a < 1$)	
When $Q_x \leq 10$ ($D_x \geq 0.1$)	$\pm \frac{Q_x^2 \times E (1 + D_x) / 100}{1 m Q_x \times E (1 + D_x) / 100}$
When $Q_x > 10$ ($D_x < 0.1$)	$\pm \frac{Q_x^2 \times E / 100}{1 m Q_x \times E / 100}$
G precision	
When $D_x > 0.1$	$\pm E \times \frac{\sqrt{1+D_x^2}}{D_x} [\%]$
When $D_x \leq 0.1$	$\pm E/D_x$ [%]

Note

D_x : Measured value of D.

Q_x : Measured value of Q.

D_a : Measurement accuracy of D.

In an AC magnetic field, the following equations can be used to calculate the measurement accuracy.

$$E \times (1 + B \times (5 + 500 / V_{mv})) [\%] \text{ (typ.)}$$

B : Magnetic induction [Gauss]

Impedance measurement accuracy of four-terminal-to-port

Impedance measurement accuracy of four-terminal pair port [%] (typ.) :

$$E = E'_p + \left(\frac{Z'_s}{|Z_x|} + Y'_0 \times |Z_x| \right) \times 100$$

in:

$$E_p' = E_{pl} + E_{pbw} + E_{posc} + E_p [\%]$$

$$Y_o' = Y_{ol} + K_{bw} \times K_{y_{osc}} \times (Y_{odc} + Y_o) [S]$$

$$Z_s' = Z_{sl} + K_{bw} \times K_{z_{osc}} \times Z_s [\Omega]$$

$E_{pl} [\%]$	Cable length correction factor: 0 m: 0 1 meter: $0.02 + 2 \times f_m/100$ 2 meters: $0.02 + 3 \times f_m/100$
$E_{pbw} [\%]$	Measurement time 5:0 Measurement time 4: 0.06 (when frequency < 50 kHz), 0.03 (when frequency \geq 50 kHz) Measurement time 3: 0.2 (when frequency < 50 kHz), 0.1 (when frequency \geq 50 kHz) Measurement time 2: 0.4 (when frequency < 50 kHz), 0.2 (when frequency \geq 50 kHz) Measurement time 1: 0.8 (when frequency < 50 kHz), 0.4 (when frequency \geq 50 kHz)
$E_{posc} [\%]$	$V_{osc} > 500 \text{ mV}$: $0.018 \times (1000/V_{mv} - 1) + f_m/100$ $200 \text{ mV} < V_{osc} \leq 500 \text{ mV}$: $0.018 \times (500/V_{mv} - 1)$ $100 \text{ mV} < V_{osc} \leq 200 \text{ mV}$: $0.018 \times (200/V_{mv} - 1)$ $V_{osc} \leq 100 \text{ mV}$: $(100/V_{mv} - 1) \times (0.018 + E_{pbw})$
$E_p [\%]$	$20 \text{ Hz} \leq f_m < 100 \text{ Hz}$: 0.5 $100 \text{ Hz} \leq f_m \leq 800 \text{ Hz}$: 0.3 $800 \text{ Hz} < f_m \leq 1 \text{ MHz}$: 0.075 $1 \text{ MHz} < f_m \leq 15 \text{ MHz}$: $0.1 \times f_m$ $15 \text{ MHz} < f_m \leq 120 \text{ MHz}$: 1.5
$Y_{ol} [S]$	0 meters : 0 1 meter : $500n \times f_m/100$ 2 meters : $1\mu \times f_m/100$
K_{bw}	Measurement time 5:1 Measurement time 4:1 Measurement time 3: 3 (when frequency \leq 1 MHz), 4 (when frequency > 1 MHz) Measurement time 2: 4 (when frequency \leq 1 MHz), 5 (when frequency > 1 MHz) Measurement time 1: 6 (when frequency \leq 1 MHz), 10 (when frequency > 1 MHz)
$K_{y_{osc}}$	$V_{osc} > 500 \text{ mV}$: $1000/V_{mv}$ $V_{osc} \leq 500 \text{ mV}$: $500/V_{mv}$
$Y_{odc} [S]$	$0 \text{ mA} \leq \text{DC current} < 1 \text{ mA}$: 0 $1 \text{ mA} \leq \text{DC current} < 10 \text{ mA}$: 1μ $10 \text{ mA} \leq \text{DC current}$ Hour: 10μ

Y_o [S]	$20 \text{ Hz} \leq f_m < 100 \text{ Hz}$: 10 n $100 \text{ Hz} \leq f_m \leq 200 \text{ kHz}$: 2.5 n $200 \text{ kHz} < f_m \leq 500 \text{ kHz}$: 5 n $500 \text{ kHz} < f_m \leq 1 \text{ MHz}$: 10 n $1 \text{ MHz} < f_m \leq 15 \text{ MHz}$: 100 n $15 \text{ MHz} < f_m \leq 120 \text{ MHz}$: 500 n
Z_{sl} [Ω]	0 meters: 0 1m, 2m: $20 \text{ Hz} \leq f_m < 500 \text{ Hz}$: 5 m $500 \text{ Hz} \leq f_m \leq 120 \text{ MHz}$: 2 m
Kz_{osc}	$V_{osc} > 500 \text{ mV}$: 2 $200 \text{ mV} < V_{osc} \leq 500 \text{ mV}$: 1 $100 \text{ mV} < V_{osc} \leq 200 \text{ mV}$: $200 / V_{mv}$ $V_{osc} \leq 100 \text{ mV}$: $100 / V_{mv}$
Z_s [Ω]	$20 \text{ Hz} \leq f_m < 100 \text{ Hz}$: 10 m $100 \text{ Hz} \leq f_m \leq 120 \text{ MHz}$: 2.5 m

Note

f_m : measurement frequency [MHz]

V_{osc} : test level

V_{mv} : V_{osc} [mV]

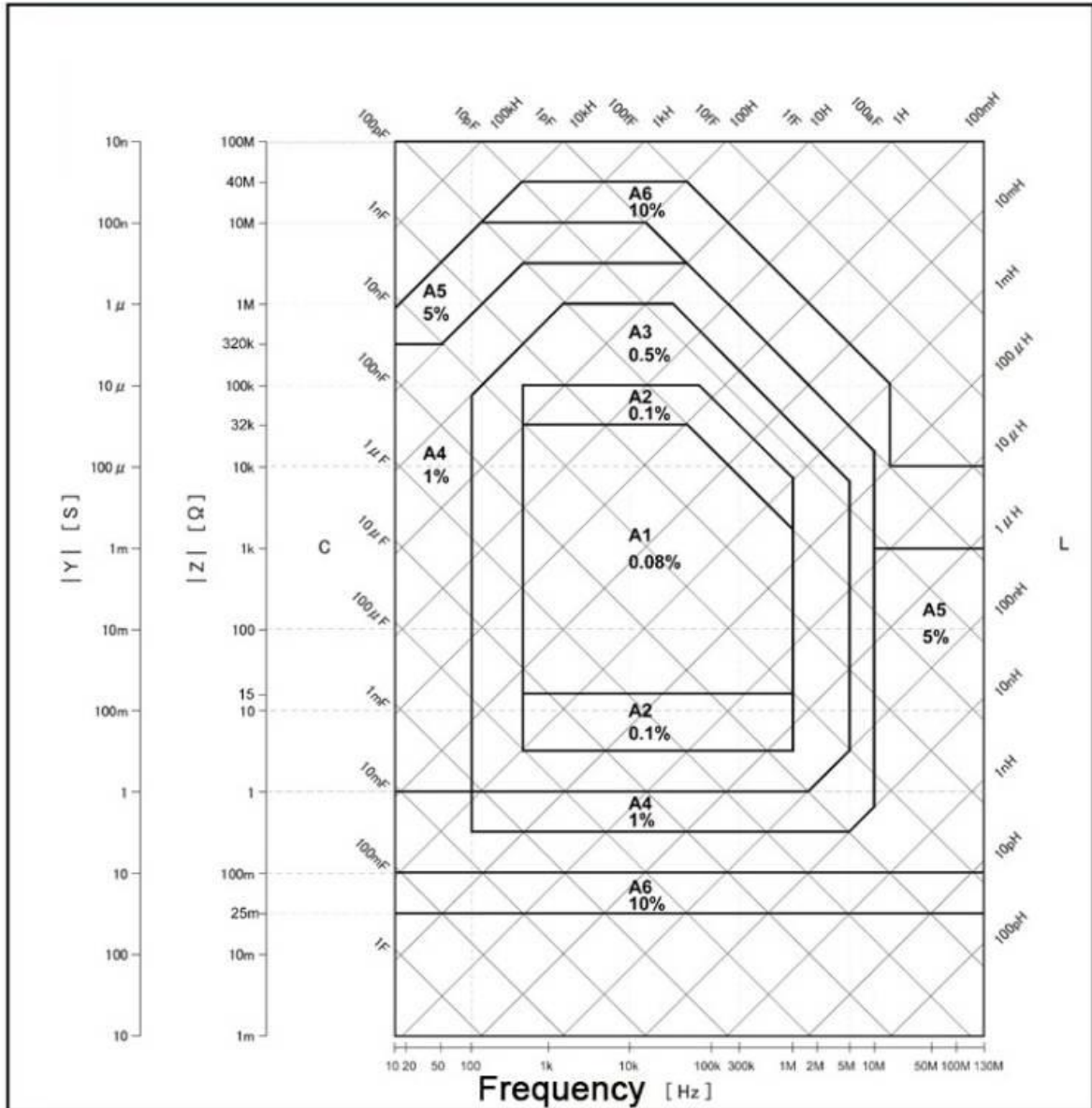

Note:

Typical value of impedance measurement accuracy of four ports on the front panel of STB8851 (test signal level 0.5 Vrms, measurement time is 5)

Other areas that do not indicate the test accuracy are not used as accuracy indicators.