

# **Microwave & Millimeter Wave Noise Figure Measurement Solutions**

## **By Saluki Technology Inc.**

**I****Company Profile****II****Noise Figure Test Basics****III****Noise Figure Measurement Solutions****IV****Competitiveness Analysis**

# About Saluki

Saluki is a leading provider on high-quality Optical and RF Test equipment. Saluki has the best products range from optical test equipment, RF & MW test equipment to RF Components.

Headquarter in Taipei, we concentrate on providing the best product world wide for more than 20 years since 1997. Now, Saluki has branch offices in provinces of mainland China, Malaysia, Indonesia and is expending worldwide.

Valuable partners in Germany, UK, Italy, Finland, Poland, USA, Israel, South Korea and Russia countries.



# Brand Name

Saluki is the most ancient breed of hunting dogs. Accurate, Fast and Reliable definite what a great hunting dog and what a great test and measurement equipment should be.

Saluki Technology takes its name from the hunting dog and dedicated to provide customer the best products

## Our Vision

To be a reliable and trust band in Test and Measurement market !

Crear Value for customers!



# SALUKI in Global Market

## Branch Offices

- China
- Malaysia

## Valuable Distributor

- ◆ Canada
- ◆ Germany
- ◆ UK
- ◆ South Korea
- ◆ South America
- ◆ Russia
- ◆ Israel
- ◆ Italy
- ◆ Finland
- ◆ Poland



# Product Lines

➤ **Signal Generators**

Main machine reaches max 67GHz. Saluki also has solution for up to **500GHz** signal generator

➤ **Vector Network Analyzers**

Saluki provides VNA from 7.5GHz, to max 67GHz. Saluki VNA frequency extenders max to 500GHZ. Cable & Antenna analyzer is one of the best in market

➤ **Signal / Spectrum Analyzers**

Saluki has bench-top spectrum analyzer max reaches 50GHz (extendable to 350GHz). Saluki also has handheld spectrum analyzers for field use, up to 44GHz

➤ **GNSS Simulator**

Has the world highest technology, best solution in Navigation Field

➤ **Optical Instrument @ [www.fibertests.com](http://www.fibertests.com)**

Fusion Splicer, OTDR

➤ **RF Components @ [www.salukirf.com](http://www.salukirf.com)**

RF adapters, cables, calibration kits

# Instruments & Components



# System Integration/ Total Solution



# Contents

**I**

**Company Profile**

**II**

**Noise Figure Test Basics**

**III**

**Noise Figure Measurement Solutions**

**IV**

**Competitiveness Analysis**



# 1 Why do we need Noise Figure?

$$NF = 10 \log_{10}(F) = 10 \log_{10} \left( \frac{SNR_i}{SNR_o} \right) = SNR_{i, dB} - SNR_{o, dB}$$

Noise Figure is defined as the **degradation of signal-to-noise ratio** between the input and output. It is a dB value that defines the amount of noise that a device/circuit/system adds to the signal that passes through it. The smaller, the better. It is one of the key specification to quantify the ability to process very weak signals. It's widely used to characterize the features of amplifier, mixer, up/down frequency converter, receiving channel and even an entire receiver system.

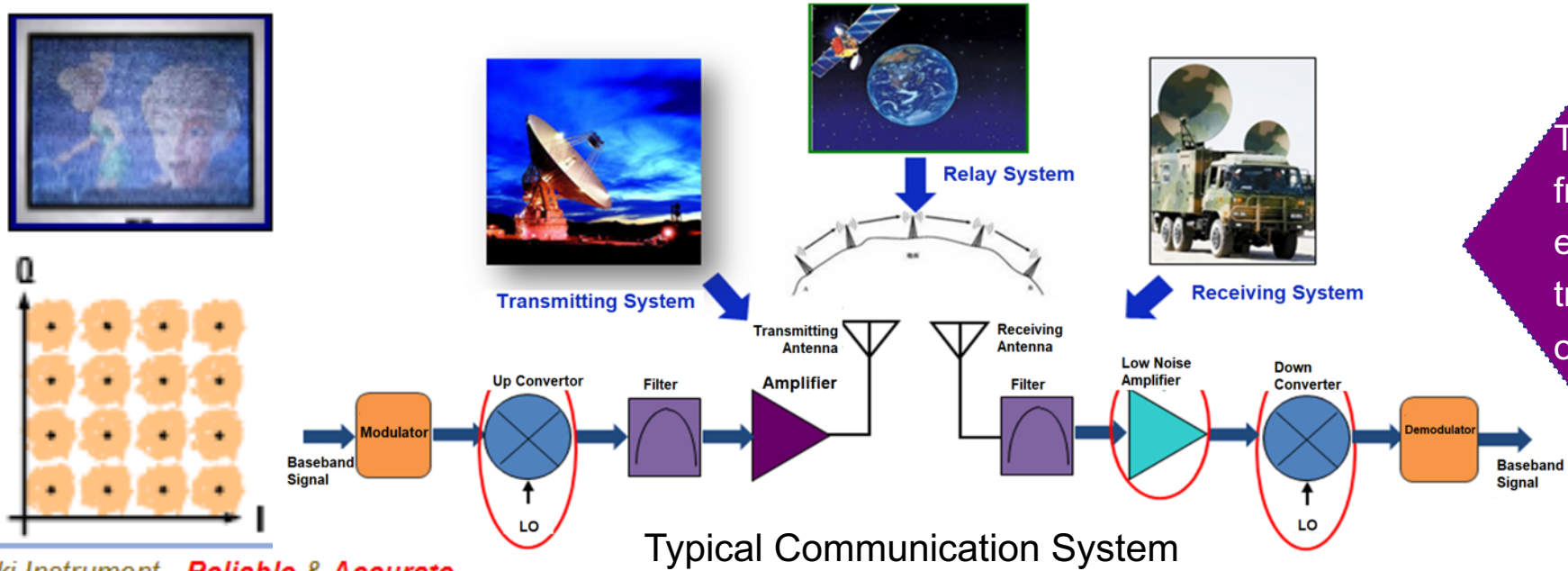

The optimization of noise figure from 2dB to 1dB for a receiver equals to an increase of 26% transmitting power, or an increase of 40% antenna diameter.

## 2.1 Two FN Measurement Theories

### A. Y Factor (Hot-Cold Source)

This method makes use of a calibrated broadband noise source that contains two temperature states: A high temperature state, T(ON source) with a higher output of noise power, and a low temperature state, T(OFF source) with reduced noise output. The noise source is applied to the input of the device under test (DUT )and the noise power at the output of the DUT is measured for each of the two input noise states. The noise figure and gain of the DUT are calculated from these measurements.

This method is suitable for **Spectrum Analyzer** with NF option and dedicated **Noise Figure Analyzer**

$$F = \frac{SNR_{in}}{SNR_{out} (1)} \quad \longrightarrow \quad N_a = kT_0BG_1 \left( \frac{ENR}{Y-1} - 1 \right) \quad \quad ENR = \frac{T_{hot} - T_{cold}}{290K}$$

## 2.2 Two FN Measurement Theories

### B. Cold Source

The other method is the cold-source or direct-noise method. E-cal can change the source match around 50  $\Omega$ . Using the noise power and vector error model under different impedances, the method can calculate the accurate Noise Figure under 50  $\Omega$ .

This method is suitable for **Vector Network Analyzer** with NF option.

- Provide mismatch correction algorithm
- S-parameters data can reduce noise figure uncertainty
- Requires a tuner and analysis software
- Measurement system can be complex and expensive

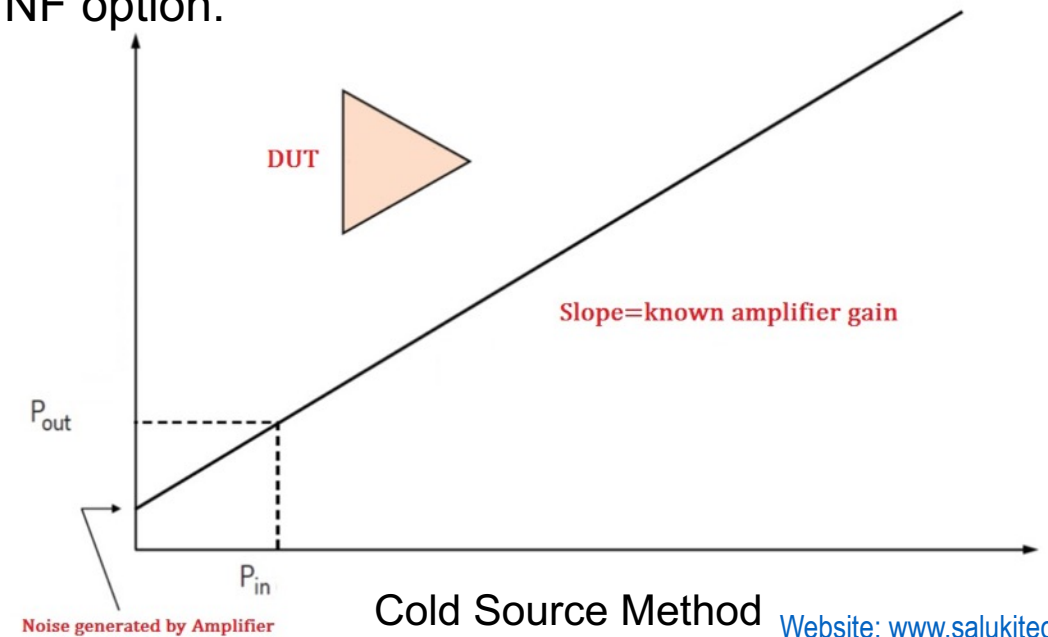

## 2.3 Two NF Method Comparison

### Features

#### ◆ Y-factor method

- The most common method and most cost-efficient solution
- When the Noise Source can be connected to the DUT and the ENR is low, this method can provide high and acceptable accuracy
- The noise source is needed during calibration and measurement process

#### ◆ Cold-source method

- Work with high performance VNA, can provide S parameter, compression and NF at the same time
- Have the highest measurement accuracy.
- Need VNA, E-cal and Noise Source. The most costly solution.
- The noise source is needed during calibration process

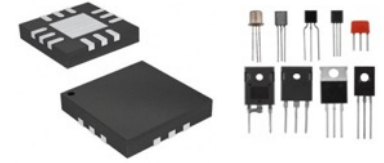

Low Noise Ics  
Amplifier, Transistor, T/R



Mixers and Up/ Down Converter



Signal Receiver Chain

# Contents

**I****Company Profile****II****Noise Figure Test Basics****III****Noise Figure Measurement Solutions****IV****Competitiveness Analysis**

# 1. NF Measurement Solutions

**Noise Figure Measurement System** can automatically measure the NF of linear or quasilinear network. It can perform many functions, such as calibration process, error correction and uncertainty calculation.

## Three ways to measure NF



**Noise Figure Analyzer  
(Dedicated Instrument)**



**Spectrum Analyzer  
(with NF option)**



**Vector Network Analyzer  
(with NF option)**

Together with different kind of **Noise Sources** or **Electronic-Calibration kits (E-Cal)**.  
For sub-Terahertz application, frequency extender receiving modules are also needed.

# 2.1 S3986 series Noise Figure Analyzer

## The Dedicated NF Measurement Instrument

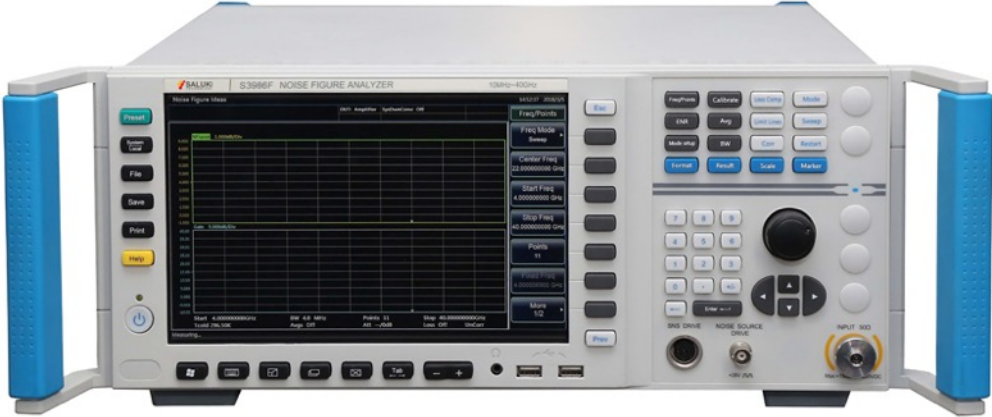

**S3986 series NF Analyzer**  
Coaxial 10MHz - 67GHz, Extendable to 110 GHz

- 10MHz to 67GHz to 110GHz
- Amplifier/ Upconverter/ Downconverter Measurement Mode
- Standard/Smart Noise Source
- Loss Compensation, Uncertainty Calculator, Limitation Functions
- Features very low internal self Noise Figure with standard pre-amplifier



**S16603 series Standard**



**S16604 series Smart Noise Source**

**Wide Freq. Range**

**High Performance**

**Multiple Function**

**Easy to Operate**

# 2.2 S3986 series Noise Figure Analyzer

## Full Banded series NF Measurement Solution

- S3986A: 10MHz - 4GHz
- S3986D: 10MHz - 18GHz
- S3986E: 10MHz - 26.5GHz
- S3986F: 10MHz - 40GHz
- S3986H: 10MHz - 50GHz
- S3986L: 10MHz - 67GHz
- Extender to 110GHz

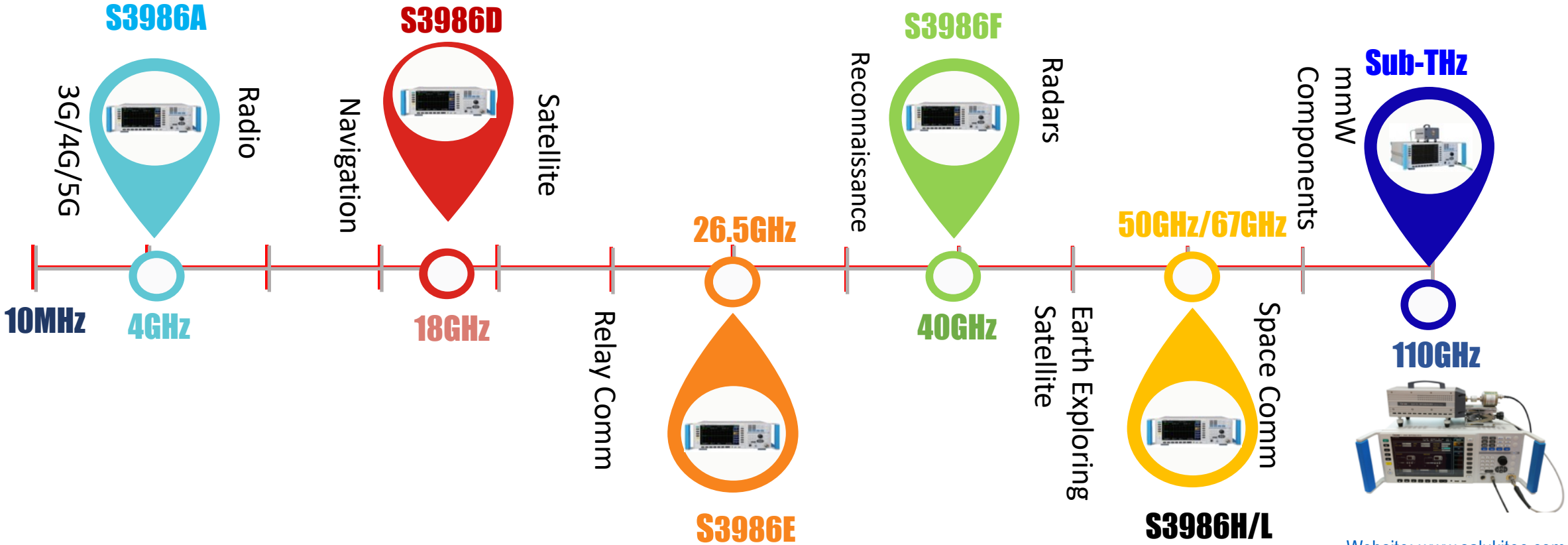



## 2.3 S3986 series Noise Figure Analyzer

### High Sensitivity, Accuracy and Reliability

#### High Sensitivity

Sensitivity is Better than -165 dBm/Hz from 10MHz to 50GHz. Best Sensitivity can be -170dBm/Hz

To solve NF measurement for ultra-low noise components, circuits and system in new radar/5G applications.

#### High Accuracy

NF Range : 0 - 35dB  
Measurement  
Uncertainty: 0.1dB

To solve accurate NF measurement featuring large NF range in transmitter and travelling-wave tube.

#### High Reliability

Endure input power: +25dBm  
Endure induced 50Hz/220V or 60Hz/110V AC impulse

Port protective circuits can guarantees a very high reliability to meet the demands from radar and communication systems for high gain IC or device.

# 2.3 S3986 series Noise Figure Analyzer

## Multiple Functions, High Stability

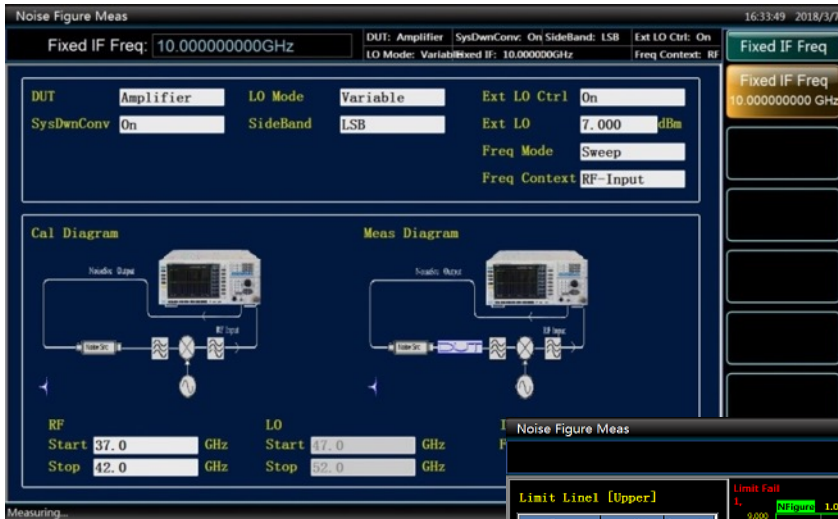

- Simple Configuration;
- Easy operation;
- Auto test of multi-stage frequency converting chain;
- Auto uncertainty calculation;
- Gain compensation before or after DUT.

- Noise power spectral density analysis
- Multiple expressions using table or curves
- Built-in uncertainty calculator



## NF and Gain changing within 8 hours

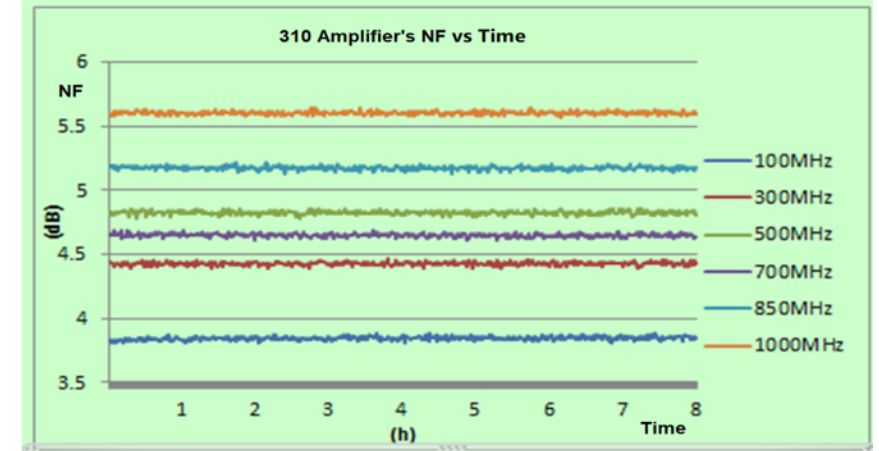

Noise Figure drift < 0.1dB

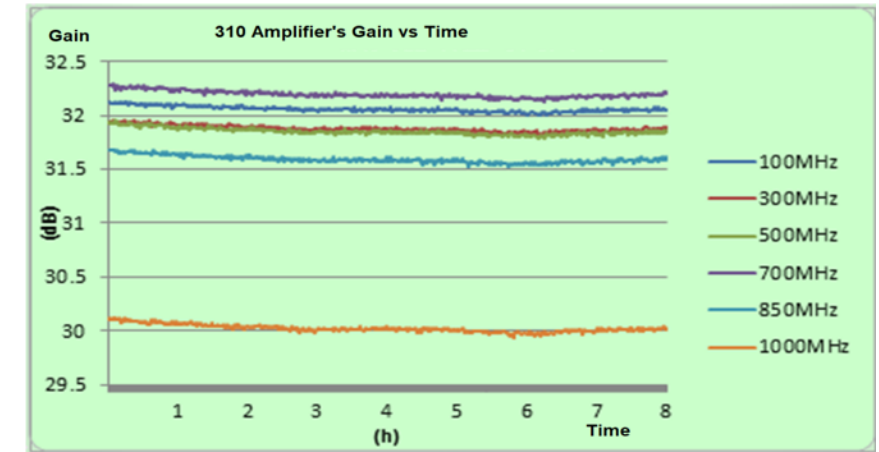

Gain drift < 0.2dB within 8 hours

Website: [www.salukitec.com](http://www.salukitec.com)

Contact: [sales@salukitec.com](mailto:sales@salukitec.com)

# 2.4 S3986 series Noise Figure Analyzer

## Multiple Functions

A. NF and Gain measurement for Linear components and systems

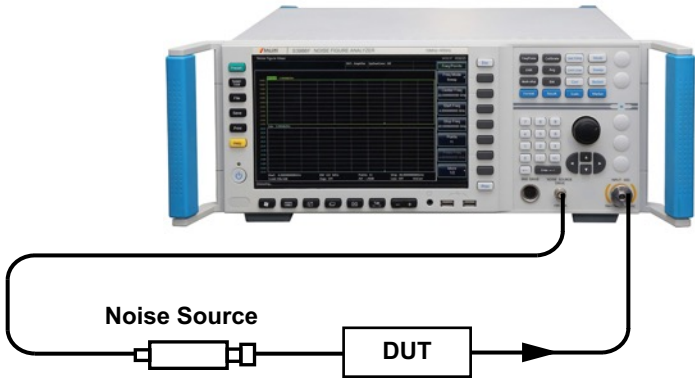

### A. Basic Amplifier Mode

For common amplifier NF and Gain measurements.

B. NF and Gain measurement for Amplifier with higher frequency

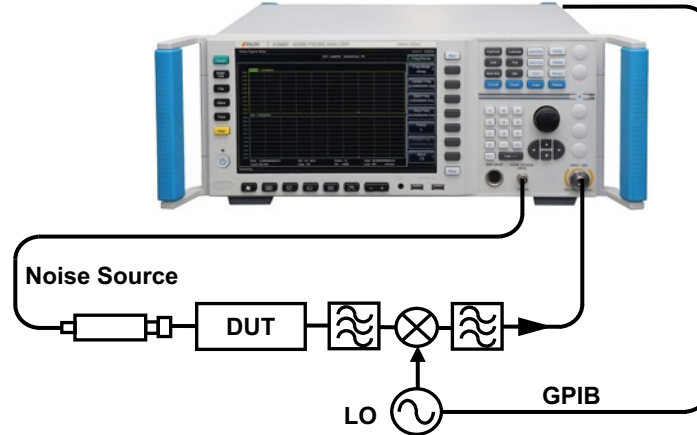

### B. System Down Converter Mode

When the amplifier's frequency is larger than the NF's, an external mixer can be configured to down-convert the frequency.

C. NF and Gain measurement for Up/Down Converter and Receiver Front-end Channel

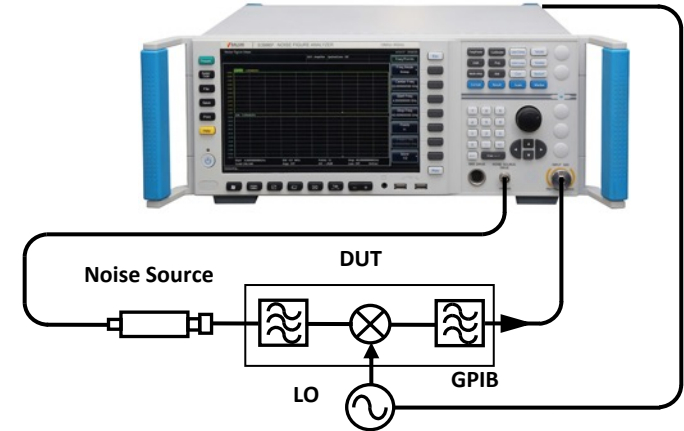

### C. Up/down converter measurement

When the DUT is up/down converter, such as mixer, transmitter/ receiver, you can control an external LO through GPIB to make the measurement

## 2.5 S3986 series Noise Figure Analyzer

### S3986 series NF Analyzer Configuration Selection

Model	Frequency	NF Range	NF Measurement Uncertainty	Ports
S3986A	10MHz - 4GHz	0 - 30dB	±0.05dB	Input: 3.5mm(m) Noise Source: Standard BNC or Smart Multi-cords
		0 - 35dB	±0.10dB	
S3986D	10MHz - 18GHz	0 - 30dB	±0.10dB	
		0 - 35dB	±0.15dB	
S3986E	10MHz - 26.5GHz	0 - 30dB	±0.10dB	
		0 - 35dB	±0.15dB	
S3986F	10MHz - 40GHz	0 - 30dB	±0.10dB	Input: 2.4mm(m) Noise Source: Standard BNC or Smart Multi-cords
		0 - 35dB	±0.15dB	
S3986H	10MHz - 50GHz	0 - 30dB	±0.10dB	
		0 - 35dB	±0.15dB	

## 2.6 S3986 series Noise Figure Analyzer

### S16603/4 series Noise Source Selection

Noise Source Model	Frequency	ENR	Output	Types
S16603DA	10MHz - 18GHz	( 5 - 8 ) dB	3.5mm(Male)	Standard BNC
S16603DB	10MHz - 18GHz	( 14 - 17 ) dB		
S16603EB	10MHz - 26.5GHz	( 12 - 17 ) dB		
S16603FB	10MHz - 40GHz	( 12 - 19 ) dB	2.4mm(Male)	
S16603HB	10MHz - 50GHz	( 10 - 19 ) dB	1.85mm (male)	
S16603LB	10MHz - 67GHz	( 6 - 21 ) dB		
S16604DA	10MHz - 18GHz	( 5 - 8 ) dB	3.5mm(Male)	Smart
S16604DB	10MHz - 18GHz	( 14 - 17 ) dB		
S16604EB	10MHz - 26.5GHz	( 12 - 17 ) dB		
S16604FB	10MHz - 40GHz	( 12 - 19 ) dB	2.4mm(Male)	
S16604HB	10MHz - 50GHz	( 10 - 19 ) dB	1.85mm (male)	
S16604LB	10MHz - 67GHz	( 6 - 21 ) dB		

## 2.7 S3986 series Noise Figure Analyzer

### NF Measurement Frequency Extension to 110GHz

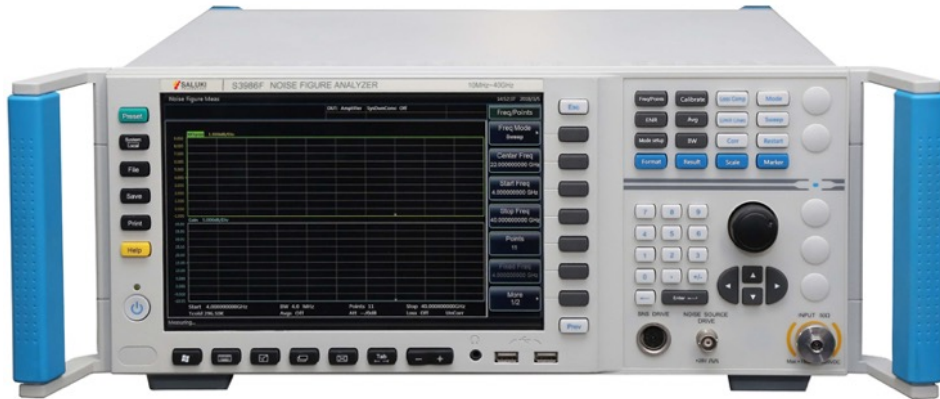

**S82411 H/K**  
(5mm)



**S82411 L/N/P**  
(3mm)



### S3986 Series Noise Figure Analyzer

- 10MHz - 50GHz Frequency Coverage
- Standard pre-amplifier configuration.
- Amplifier/Upconverter/Downconverter Measurement Mode, Support Standard/Smart Noise Source
- NFA features ultra low inherent noise figure and very low uncertainty.

### S82411 Series Noise Figure Extender Module

- 50GHz - 110 GHz Seamless Coverage
- Low SWR
- High Sensitivity and Performance

**To test mm-W amplifier and Up/down Converter's Noise Figure and Gain up to 110GHz.**

[Website: www.salukitec.com](http://www.salukitec.com)

# 2.8 S3986 series Noise Figure Analyzer

## NF Measurement Frequency Extender Modules



Saluki S82411series Frequency Extender Modules Specifications

Specifications	S82411H	S82411K	S82411L	S82411N	S82411P
Frequency Range (GHz)	50 - 63.5	61.5 - 75	75 - 88.5	86.5 - 100	96.5 - 110
Input SWR	< 1.7:1	< 1.7:1	< 1.8:1	< 1.8:1	< 1.8:1
Inherent NF (dB)	< 16	< 16	< 10	< 10	< 10
IF Output Range (GHz)	4.5 - 18	4.5 - 18	4.5 - 18	4.5 - 18	4.5 - 18
Channel Conversion Gain (dB)	> 5	> 5	> 5	> 5	> 5
Image Rejection (dB)	> 30	> 30	> 30	> 30	> 30

\* Only support S3986 series Noise Figure Analyzer.

## 2.9 S3986 series Noise Figure Analyzer

### Typical 110GHz NF Measurement Configuration



#### System Features

- Very low inherent instrument noise figure;
- Industry leading sensitivity and accuracy;
- Automatic calculation of measurement uncertainty;
- Three measurement mode with better flexibility.

#### Saluki 110GHz Noise Figure Analysis System Configuration

	Module and Name	Brand	Unit	Remarks
1	S3986 D/E/F/H/L Noise Figure Analyzer	Saluki	1	Main unit with frequency more than 18GHz
2	S82411 series Extender Modules	Saluki	1 set	Banded Modules to extend up to 110GHz. WR15/WR10
3	NC5115 or NC5110 Noise Source	Noisecom	1	50GHz to 75GHz , WR15; 75GHz to 110GHz, WR10



# 3.1 NF Option based on Spectrum Analyzer

## Saluki S3503 series Spectrum/Signal Analyzer



- 3Hz to 67GHz, to 750GHz
- Abundant measurement functions
- 550MHz analysis bandwidth
- Powerful spectrum signal analysis ability

**Wide  
Freq. Range**

**High  
Performance**

**Multiple  
Functions**

**High  
Reliability**

3Hz to 4/ 9/ 13.2/ 18/ 26.5/ 40/ 45/ 50/ 67GHz

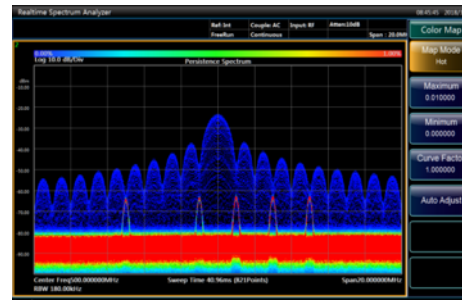
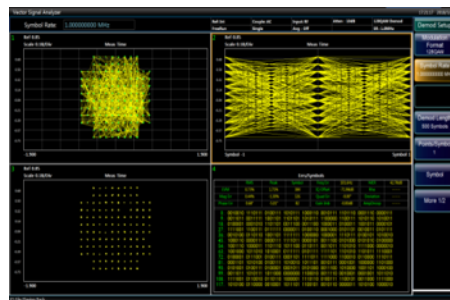

# 3.2 NF Option based on Spectrum Analyzer

## Saluki S3503 series Spectrum/Signal Analyzer



**S3503 series spectrum/Signal Analyzer**  
(H34: Pre LNA + H48: NF Option)

+

**S16603/4 series Noise Source**



Automatic Import ENR Data

**Have the same operation and screen with S3986 series NFA!**

# 3.3 NF Option based on Spectrum Analyzer

## Features

- Up to 50GHz NF measurement;
- Comprehensive noise factor measurement functions for gain, Y-factor, effective temperature, etc.
- Up to 50GHz NF measurement;
- Comprehensive noise factor measurement functions for gain, Y-factor, effective temperature, etc.
- With optional internal preamplifier on the SA
- Works with S16604 series smart noise sources and S16603 series traditional BNC-powered noise sources
- Measurement uncertainty calculator help you quickly get the uncertainty value

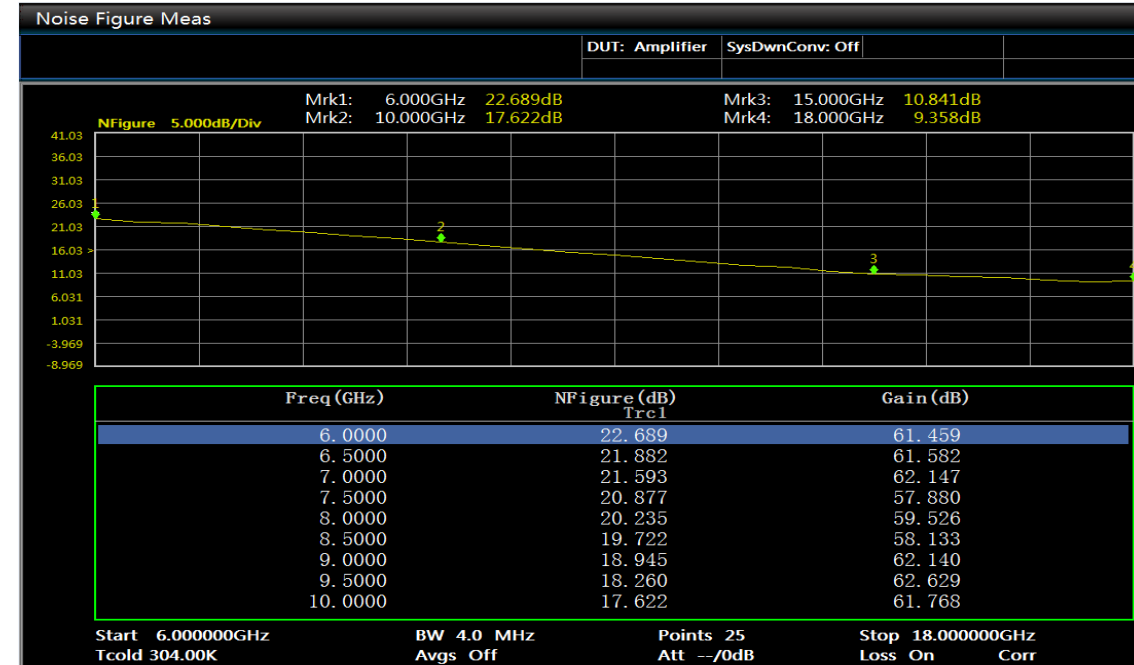

### Noise Figure & Gain Test Result

**Have the same operation and screen with S3986 series NFA!**

## 4.1 NF Measurement based on VNA

### Sakuki S3602 series Vector Network Analyzer

- Wide Freq. :10 MHz - 67GHz, extendable to 750GHz
- Outstanding Dynamic Range and Test Speed
- Highly Integrated & Configurable
- Multiple Functions with many options, Extendable features
- High Repeatability, Reliability & Stability
- Complete test configuration for different Auto Test Systems

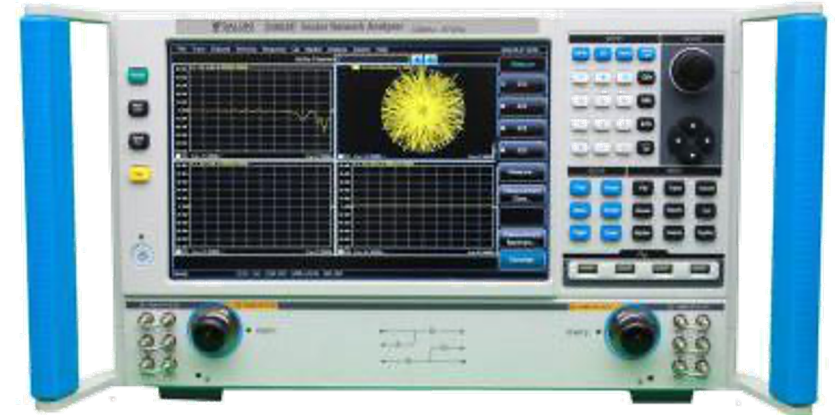

**S3602 VNA (2 or 4 ports)**

### S3602 series VNA And S364X Frequency Extender Modules

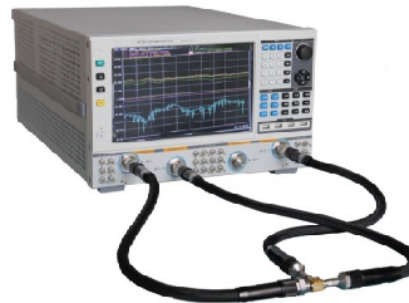

# 4.2 NF Measurement based on VNA

## How to measure NF using a VNA - 1

- Frequency from 10MHz to 50GHz
- Provide Scalar and Vector methods
- Support S parameters, Noise Figures and Noise Parameters measurement in a single connection
- Support different calibration methods



Setup NF Measurement Configuration

**S3602 series VNA**  
(003: NF Option)  
+  
**2040X series E-cal**  
+  
**S16603 series NS**



E-cal

Noise Source

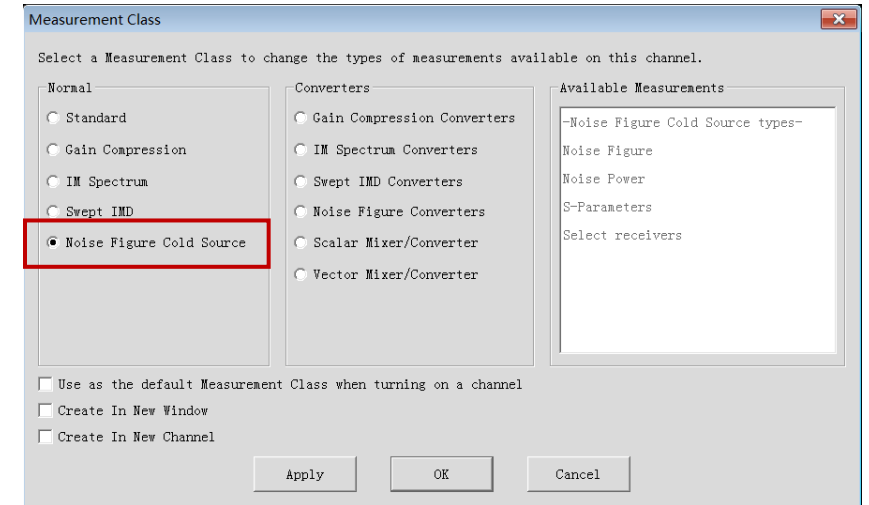

Step 1: Select Noise Figure Measurement

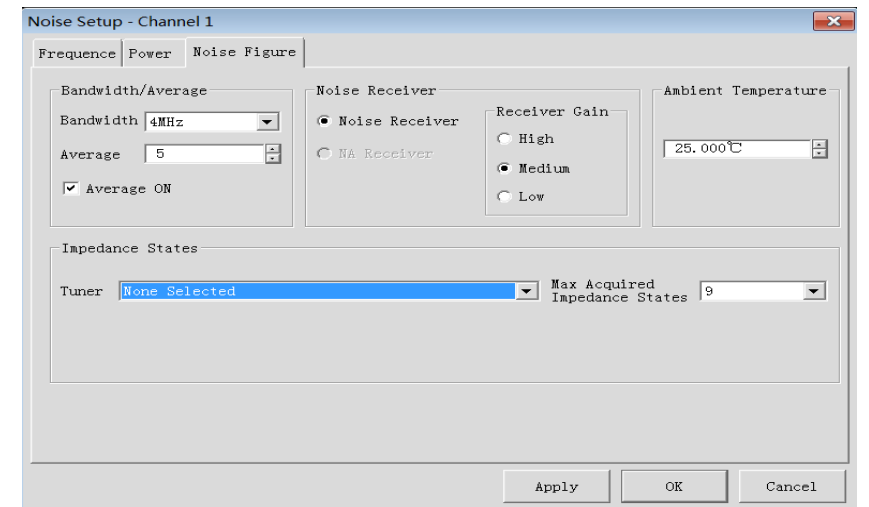

Step 2: Setup NF Measurement Configuration

Website: [www.salukitec.com](http://www.salukitec.com)

# 4.3 NF Measurement based on VNA

## How to measure NF using a VNA - 3

### Step 3: Calibration methods selection and setups

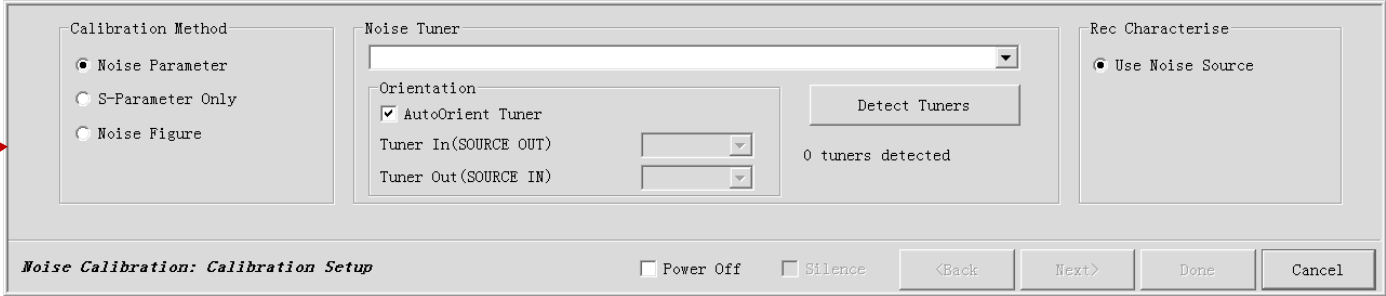
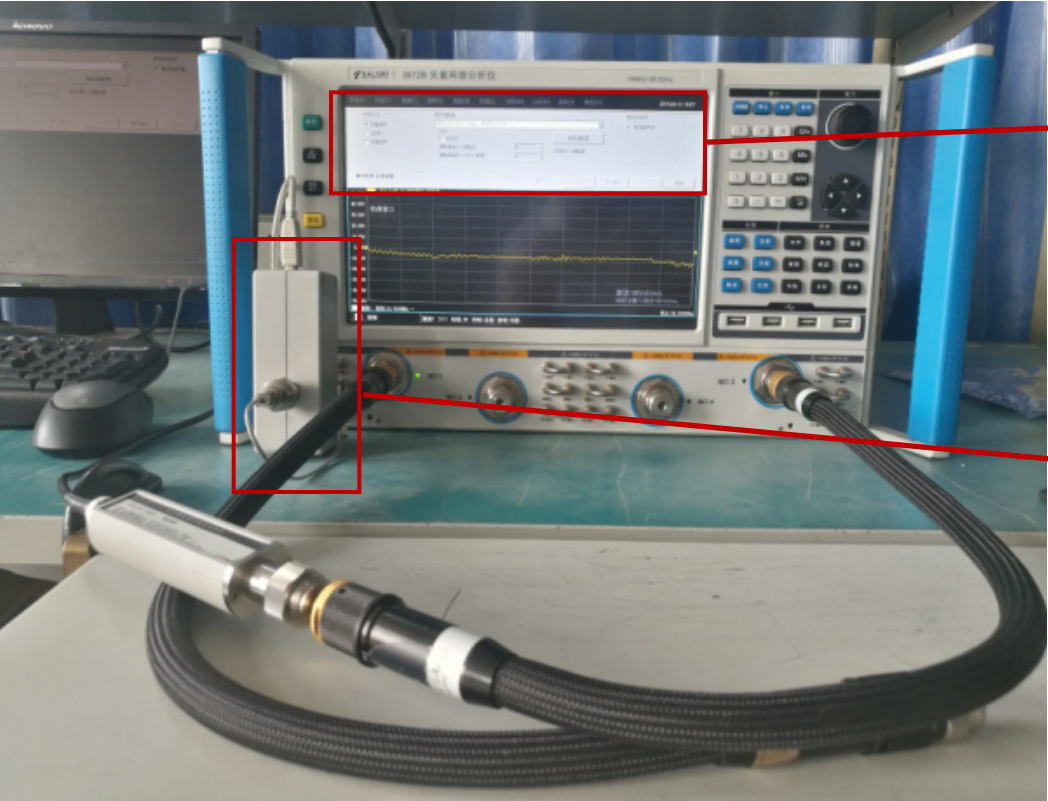

E-Cal

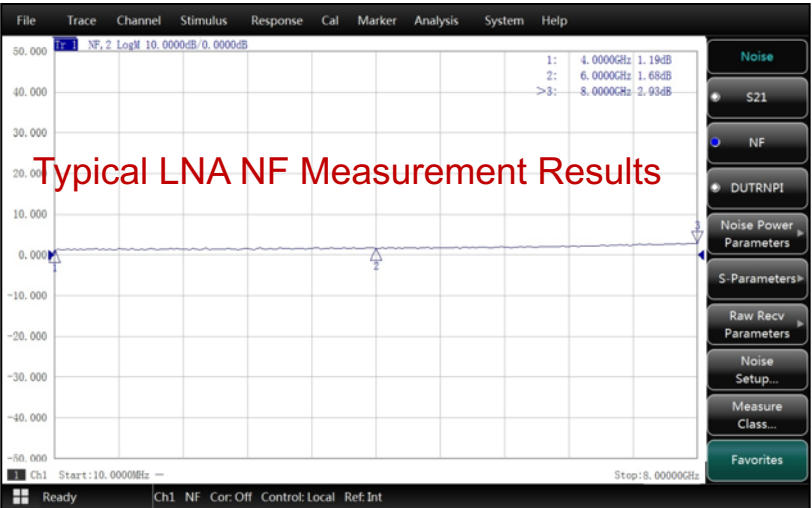

Typical LNA NF Measurement Results

# 4.4 NF Measurement based on VNA

## How to measure NF using a VNA - 4



Step 4: Connect DUT and Measure

- The E-cal and noise source is only needed in calibration process.

## NF result comparison using a VNA and NFA

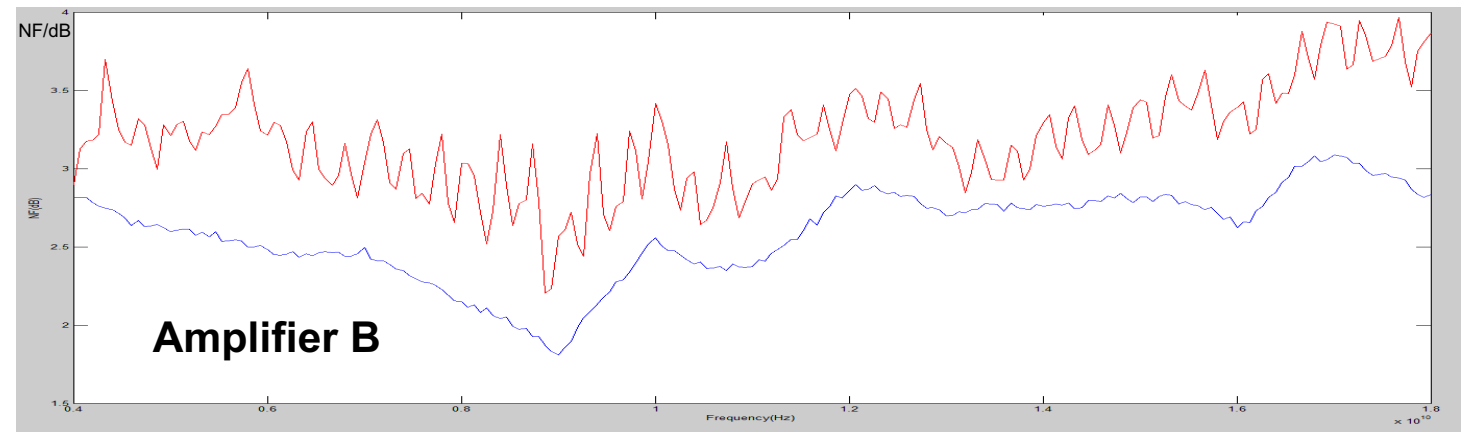
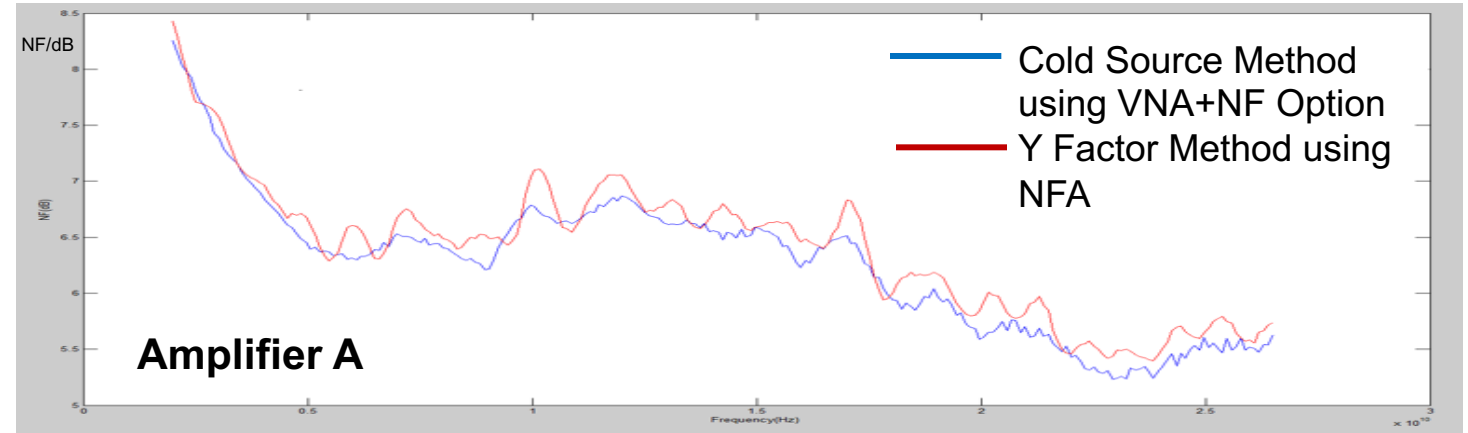

Both methods have a similar result. Cold source method based on VNA can give a more accurate and smooth value.

Website: [www.salukitec.com](http://www.salukitec.com)

Contact: [sales@salukitec.com](mailto:sales@salukitec.com)

# 4.5 NF Measurement based on VNA

Highest measurement efficiency and accuracy to characterize the component comprehensively

- Single connection for S parameters, Noise figure, Noise parameters, Compression and Inter-modulation distortion etc.
- Faster speed: at least 4-Times faster than normal NFA
- Multiple displaying types to express the results.

Screenshot of Noise Parameters Measurement using VNA

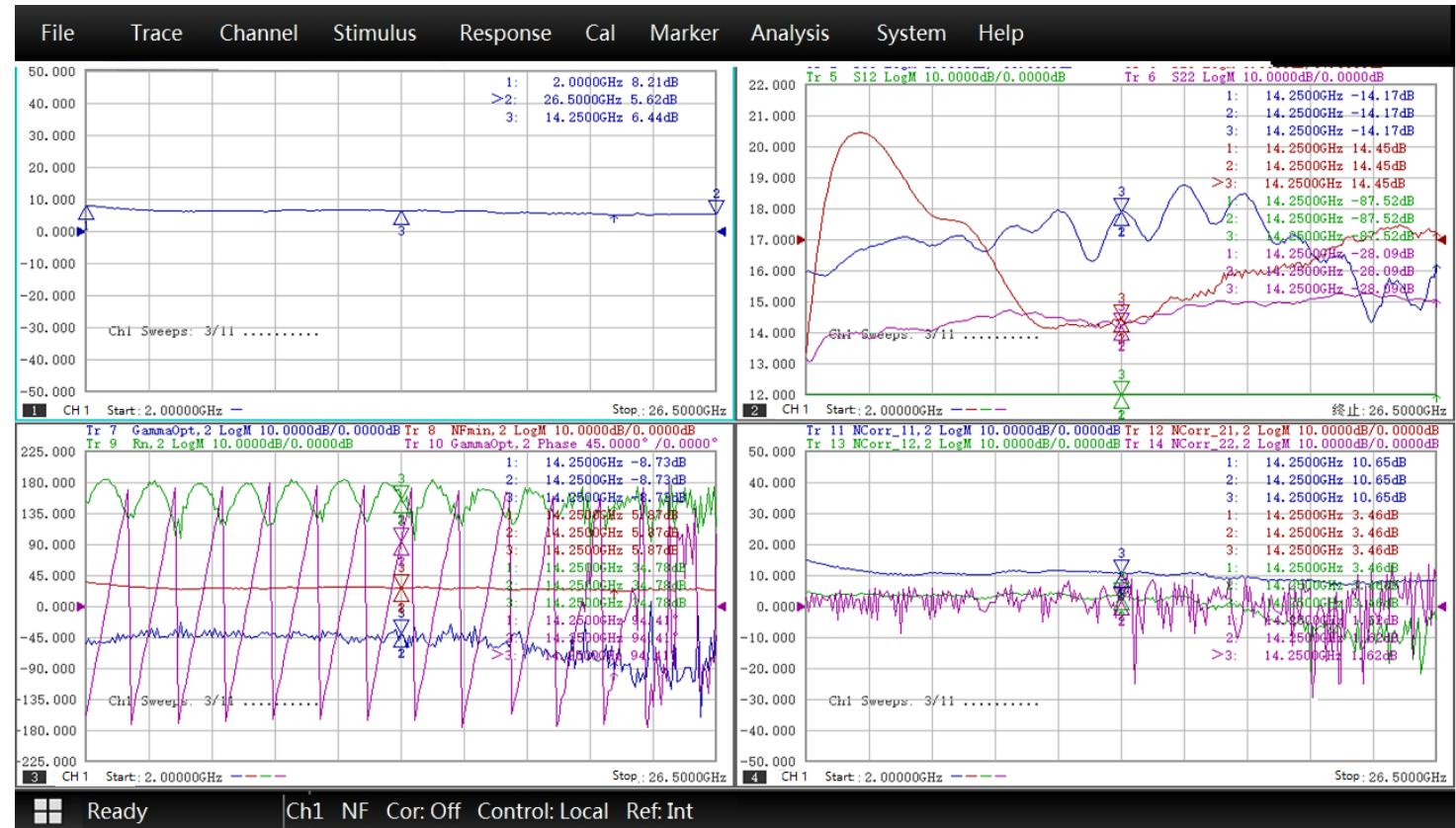

Low Noise Amplifier IC test

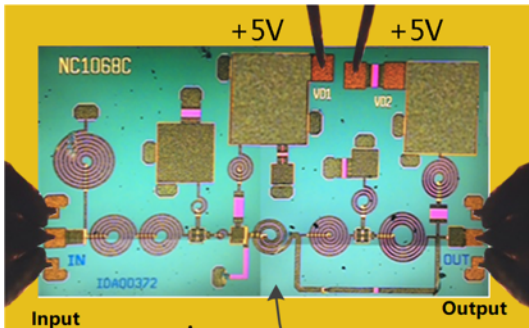



# 4.6 NF Measurement based on VNA

Perfect solution for on-wafer Noise Figure and S parameters test simultaneously.

- No need Noise Source or E-cal during measurement process;
- Perfectly work using coaxial, waveguide interfaces;
- Accurate and repeatable on-wafer device test for noise parameters and S parameters

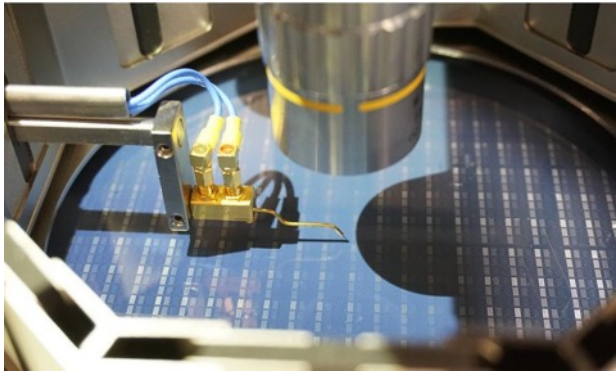

Probe Station

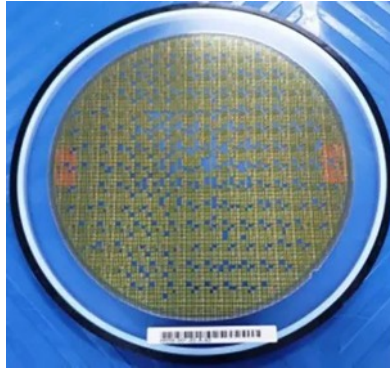

Wafer Under Test

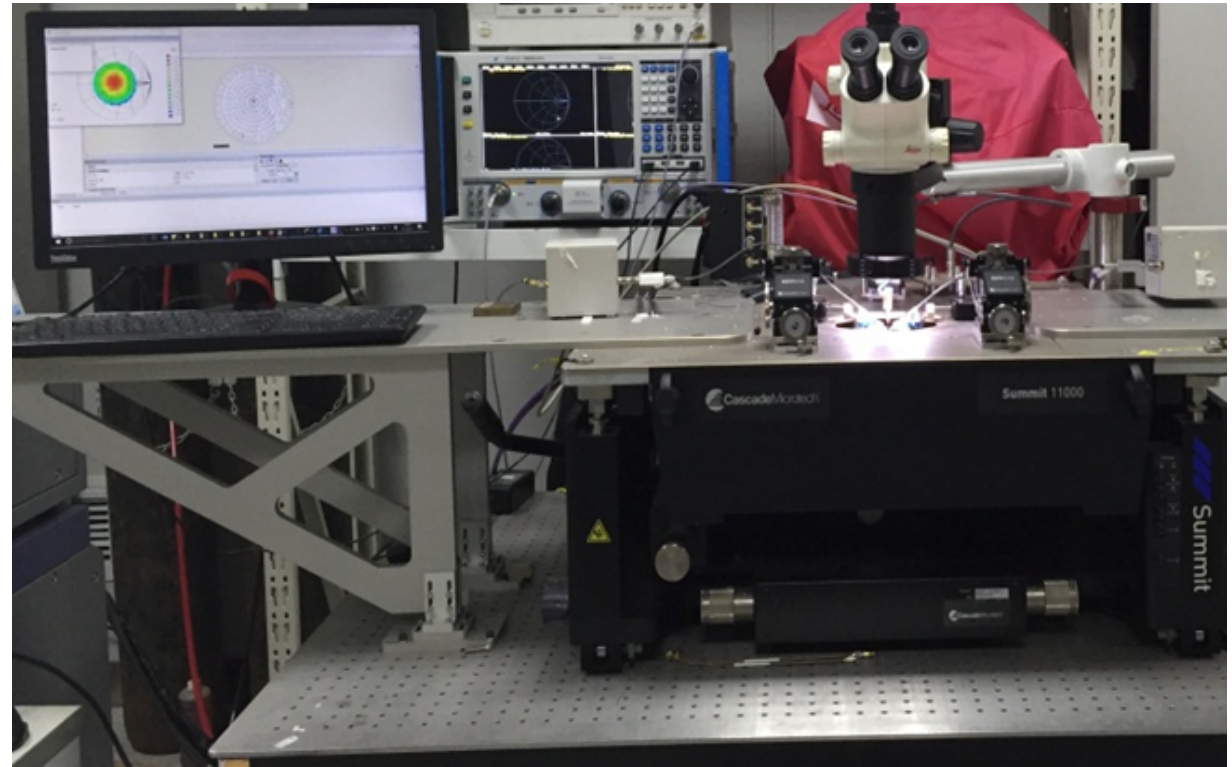

On-wafer one stop full parameters measurement platform

# 5 NF Measurement Method Comparison

## Concerns of NF Measurement Methods Selection

	Method	Configuration	Features	Measurable Parameters	Accuracy	Cost
A	Y Factor	S3986 NF Analyzer S16603/4 Noise Source	Dedicated Instrument	NF, Gain	high	low
		S3503 Spectrum Analyzer, Preamp and NF option S16603/4 Noise Source	Options on Spectrum Analyzer	NF, Gain	low	medium
B	Cold Source	S3602 VNA, NF option S16603 Noise Source	Option on VNA, on-wafer test	NF, Gain, S-parameters	higher	high
		S3602 VNA, NF option S16603 Noise Source 2040X Electronic Calibration Kits	Option on VNA, on-wafer test, wider NF test range	NF, Gain, S-parameters	Highest	higher

# Contents

**I**

**Company Profile**

**II**

**Noise Figure Test Basics**

**III**

**Noise Figure Measurement Solutions**

**IV**

**Competitiveness Analysis**



# 1 Typical Industry Analysis

## IC and component Test

Chips or module of LNA, Mixer, up/down converter



## Colleges & Universities

Electronic Engineering  
Material science and engineering  
Radio Physics

## Space Exploring and Aviation System

Signal receiving modules or chains or modules; Receiver front-end

## Metrology and Accreditation

National, Industrial stands  
Factory standards

## Radar and Satellite Comm

Signal receiving modules or chains or modules; Receiver front-end.

## 2 Typical Cases – University, Institute and Company

	Customer	Methods	Configuration
1	Qingdao RPM Electronics Co., Ltd	S3986B Noise Figure Analyzer	Security Radar R&D
2	JEZETEK Group	S3986D Noise Figure Analyzer	ICs NF and gain test, Receiving circuits test
3	Xidian University	S3986D Noise Figure Analyzer	Ics and modules NF test, circuits test, Teaching and R&D
4	Beihang University (BUAA)	S3986E Noise Figure Analyzer	ICs NF and gain test, circuits test, Teaching and R&D
5	Nanjing University of Science & Technology	S3986H Noise Figure Analyzer	NF and gain test, circuits test, Teaching and R&D
6	China National Institute of Metrology	S3602E Vector Network Analyzer with NF option	Metrology system R&D and standards constitution
7	China Aerospace Science and Industry Corporation	S3503E Spectrum/Signal Analyzer with NF option	Communication system R&D, IC/Module R&D,
8	Institute of Electronics, Chinese Academy of Science	S3503H Spectrum/Signal Analyzer with NF option	ICs R&D, communication receiver test
9	Beijing Remote Sensing Technology Institute	S3986C Noise Figure Analyzer	Receiver circuits test, system confirmation
10	Shanghai Institute of Microsystem and information Technology	S3986E Noise Figure Analyzer with 110GHz extender	Component design and microsystem confirmation
11	China Academy of Space Technology (CAST)	S3986F Noise Figure Analyzer with	Space communication receiver R&D
12	IC Valley Microelectronics Co., Ltd	S3986A Noise Figure Analyzer	ICs manufacture line
13	HW Technologies CO., Ltd	S3986D Noise Figure Analyzer and 4051E Spectrum Analyzer	Communication system R&D, 4G/5G R&D and Manufacture
14	Addvalue Innovation Pte Ltd	S3986A Noise Figure Analyzer	Satellite communication device R&D

# THANKS !

**Saluk Technology Inc.**

Address: No.367 Fuxing N Road, Taipei 105, Taiwan

E-mail: [sales@salukitec.com](mailto:sales@salukitec.com) Tel: 886.909 602 109

Web: [www.salukitec.com](http://www.salukitec.com)